

EVEREST 8x14 Domek z tworzywa/Plastic shed

Instrukcja montażu/Assembly instructions

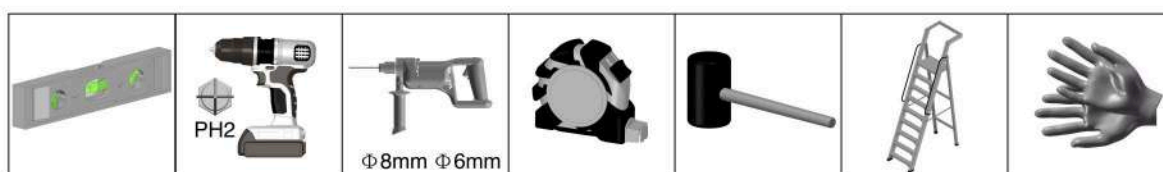

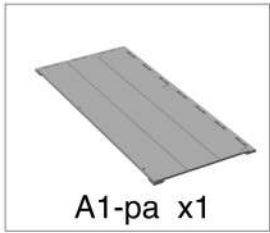
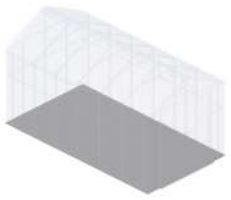

A1-pa x1

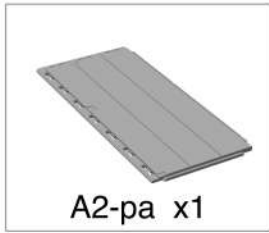

A2-pa x1

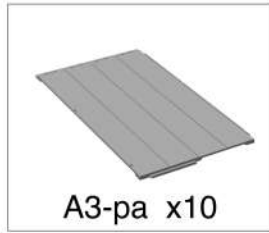

A3-pa x10

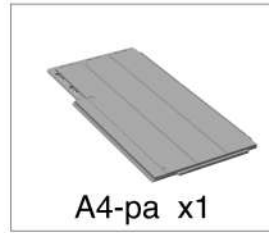

A4-pa x1

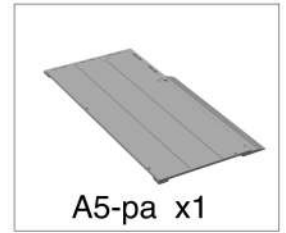

A5-pa x1

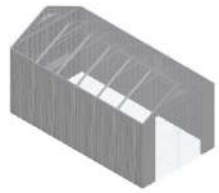

A6-pa x1

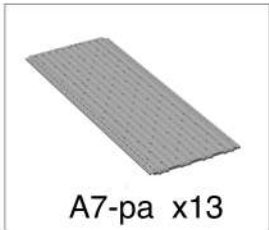

A7-pa x13



A8-pa x1

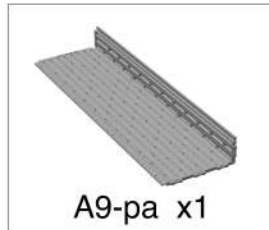

A9-pa x1

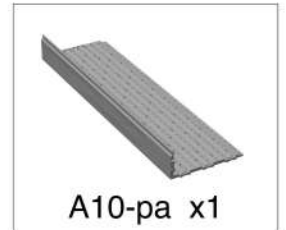

A10-pa x1

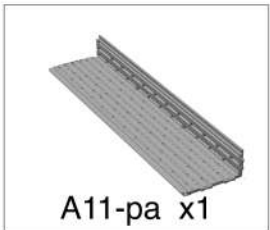

A11-pa x1

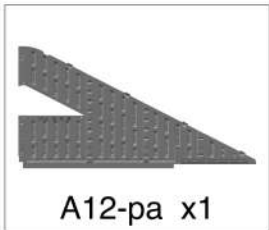

A12-pa x1

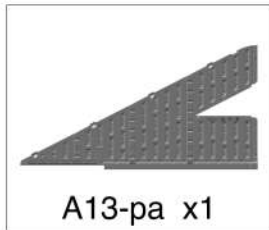

A13-pa x1

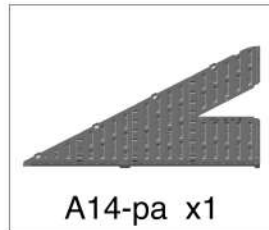

A14-pa x1

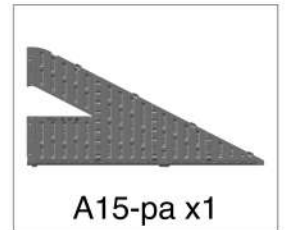

A15-pa x1

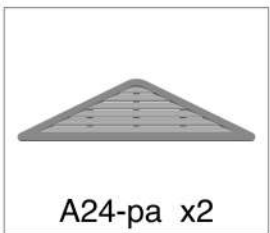

A24-pa x2



A30-pa x17

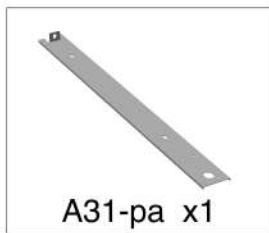

A31-pa x1



A32-pa x1

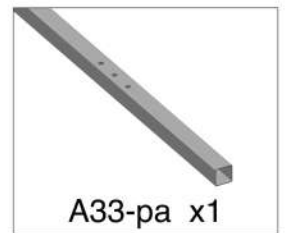

A33-pa x1



A33a-pa x1



A35-pa x2



D36-pa x1



E37-pa x1



A40-pa x10

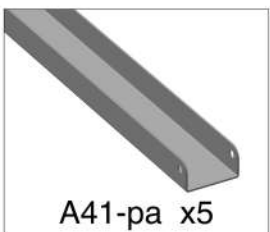

A41-pa x5



A42-pa x5



A43-pa x10

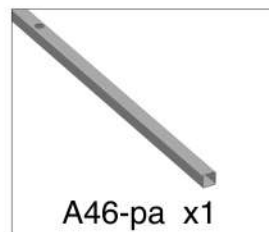

A46-pa x1



D47-pa x2



E47a-pa x2



A48-pa x2

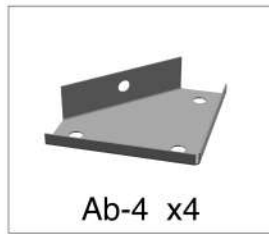

Ab-4 x4



21-pa x2



16-pa x10

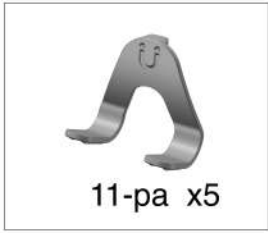

11-pa x5

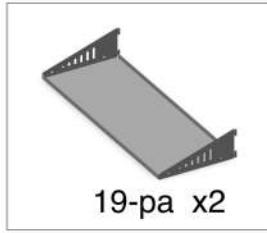

19-pa x2

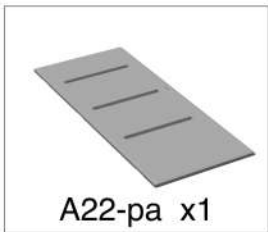

A22-pa x1

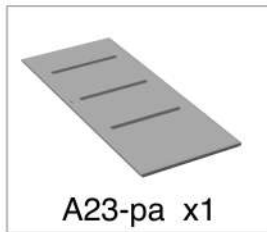

A23-pa x1



A34-pa x2



A34a-pa x2

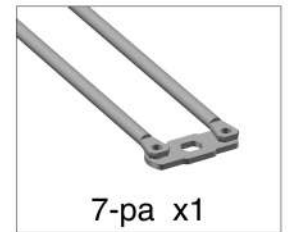

7-pa x1



8-pa x1



13-pa x2



14-pa x2



15-pa x6



1-pa x1



2-pa x1



M4x16mm

1.1-pa x4

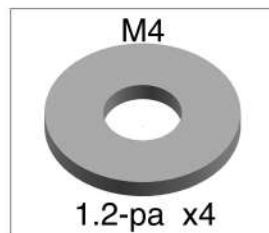

M4

1.2-pa x4

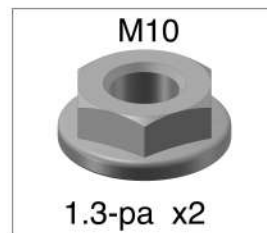

M10

1.3-pa x2

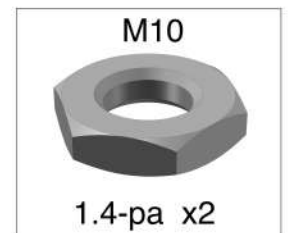

M10

1.4-pa x2

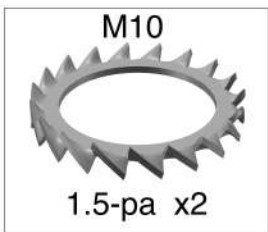

M10

1.5-pa x2

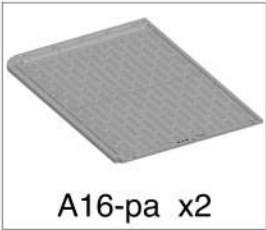

A16-pa x2

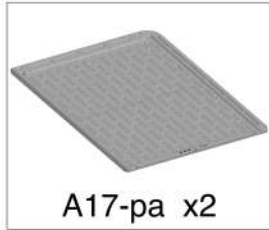

A17-pa x2

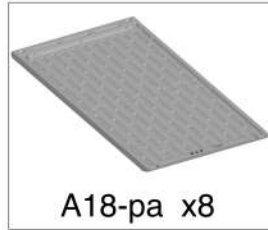

A18-pa x8



A44-pa x4



A45-pa x8



A19-pa x1

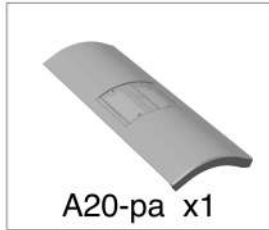

A20-pa x1



A21-pa x4



M4x10mm

E50-pa x18



ST4x12mm

E51-pa x64



ST4.2x13mm

E52-pa x4



M6x10mm

E53-pa x112



M6x18mm

E54-pa x57



M6x25mm

E55-pa x17



M6x40mm

E56-pa x7



ST6x12mm

E57-pa x20



ST6x16mm

E58-pa x181



ST6x20mm

E59-pa x84



ST8x60mm



E60-pa x19

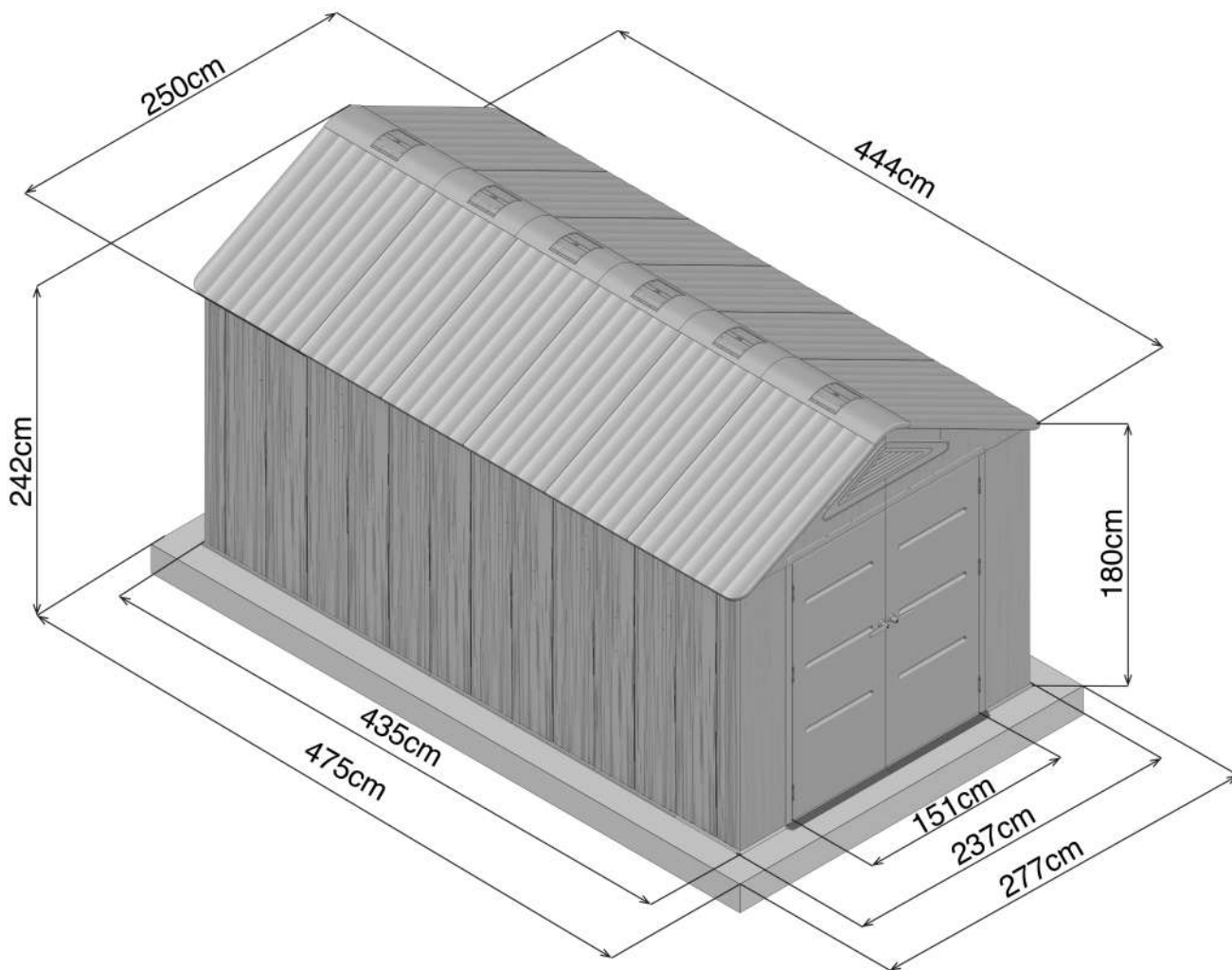

M6

E61-pa x62



1	 A1-pa x1	 A2-pa x1
----------	---	---

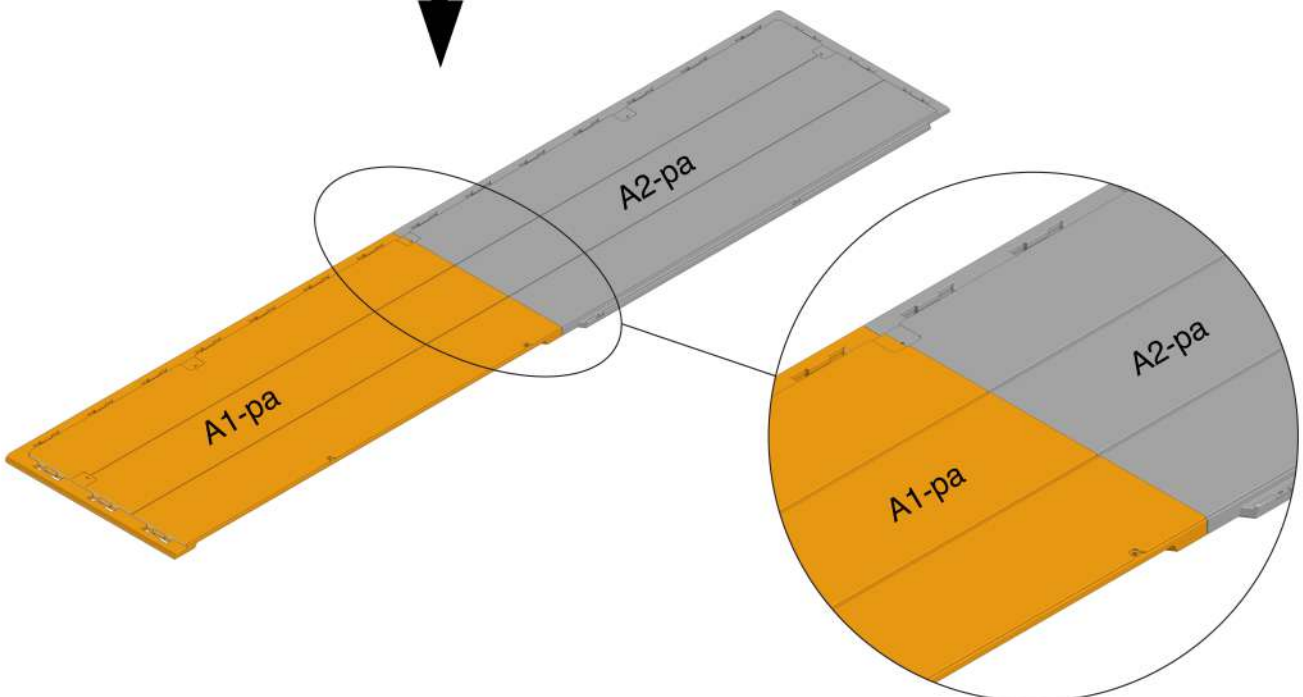
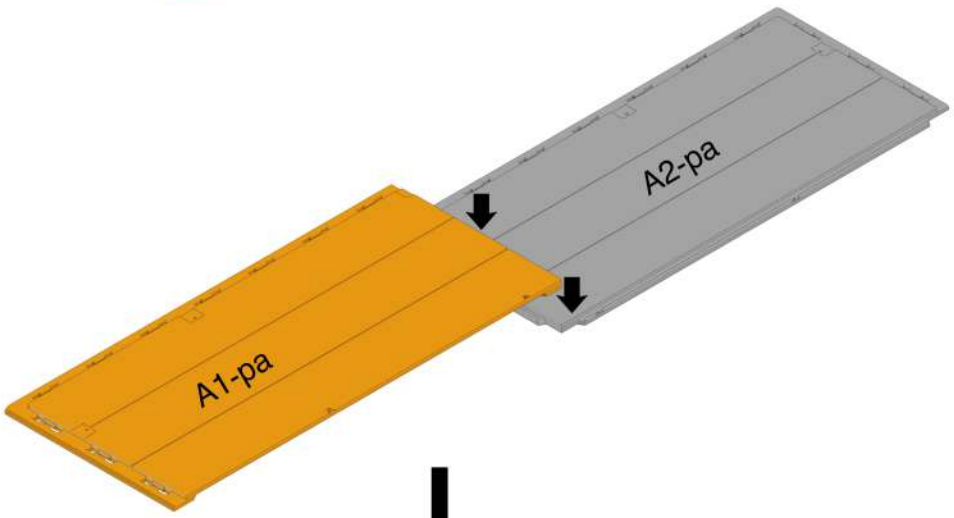
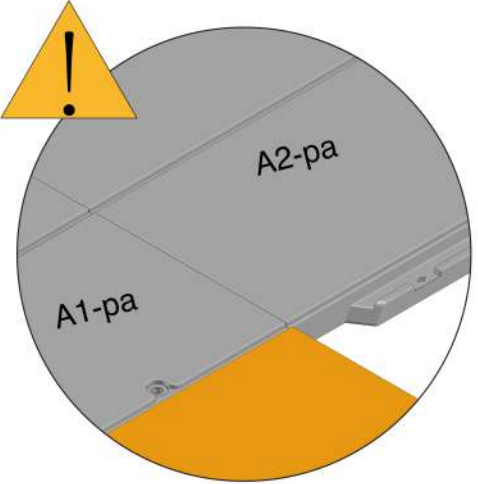
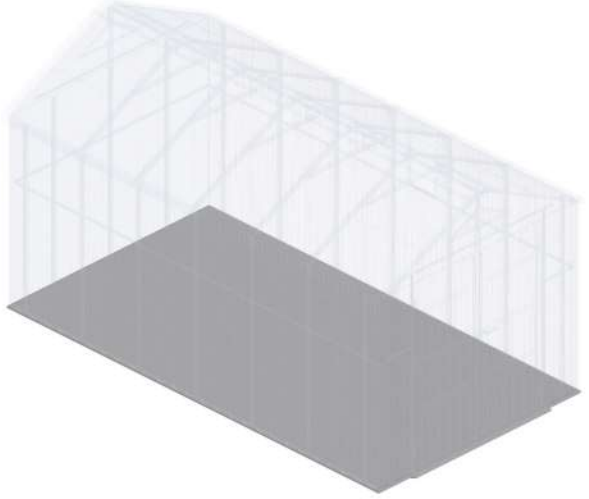

2



A3-pa x2

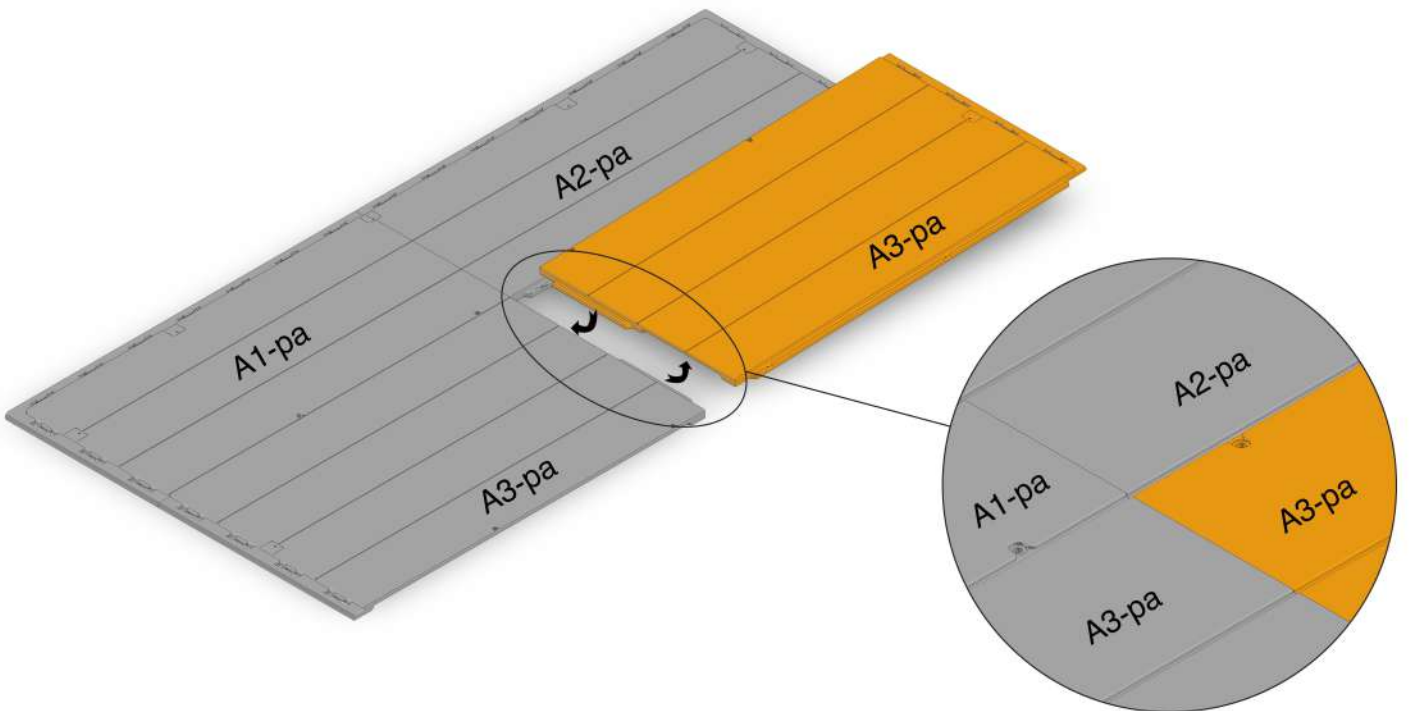
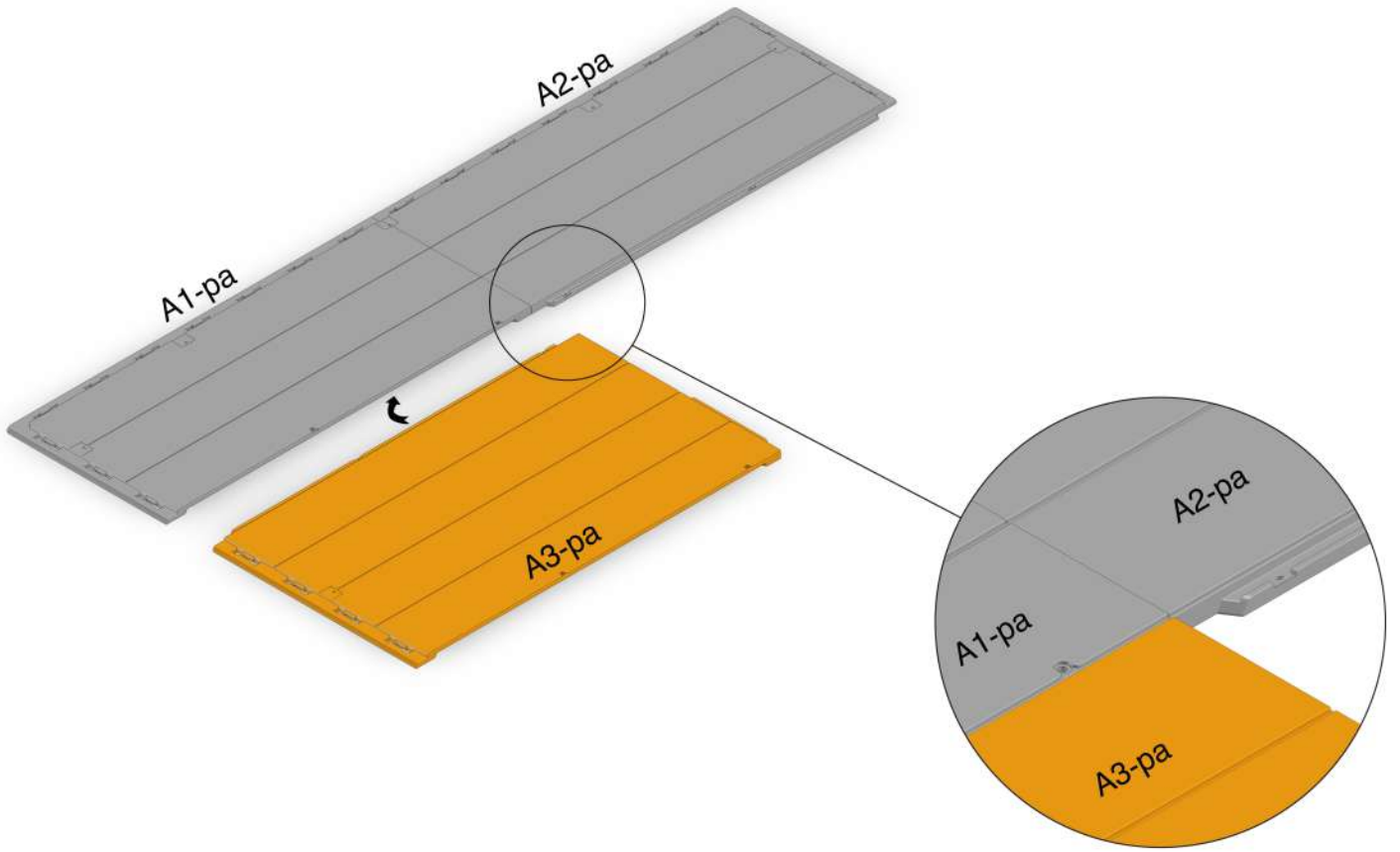

3



A3-pa x8

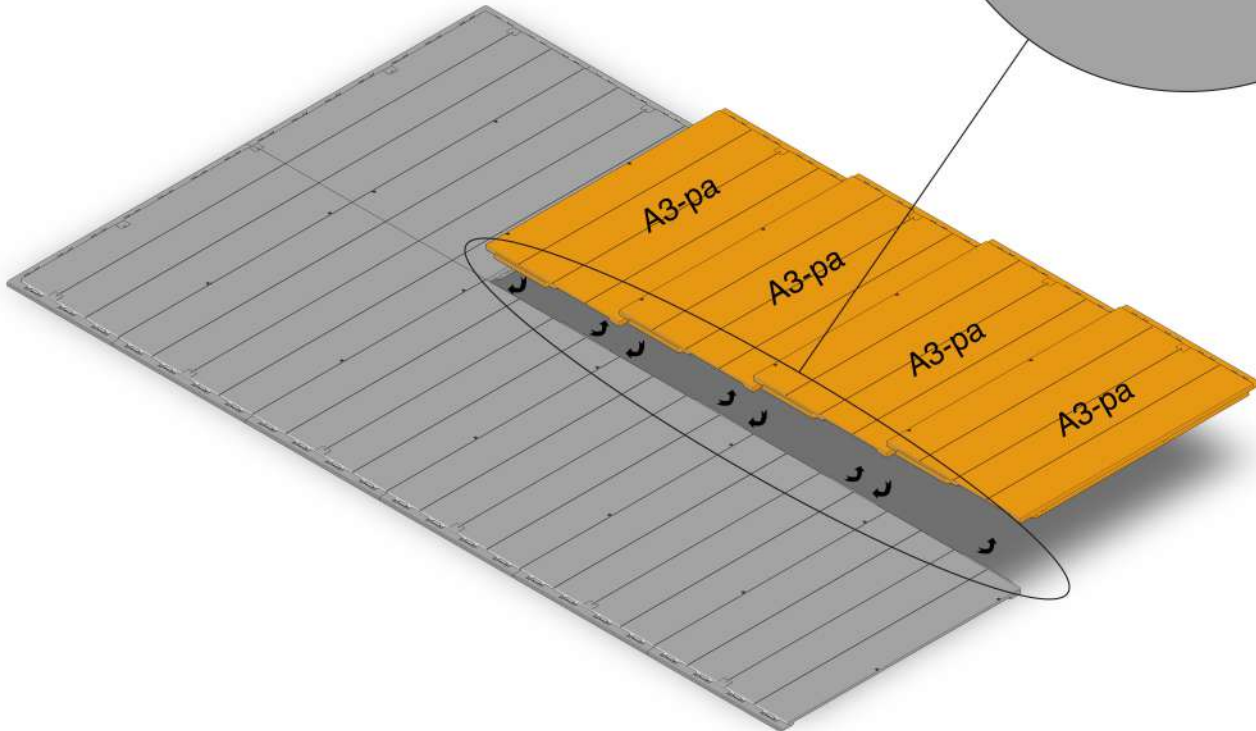
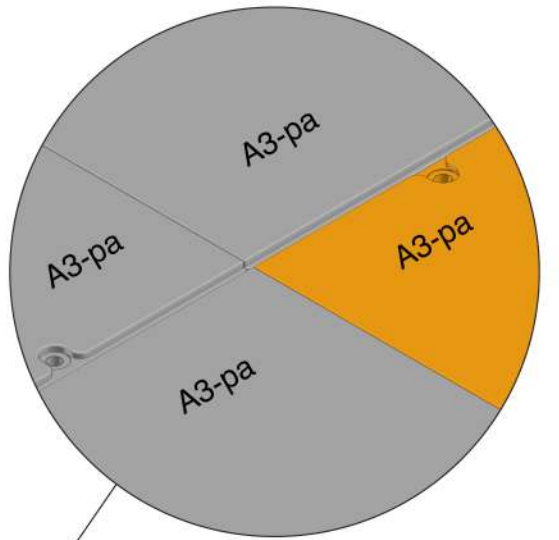
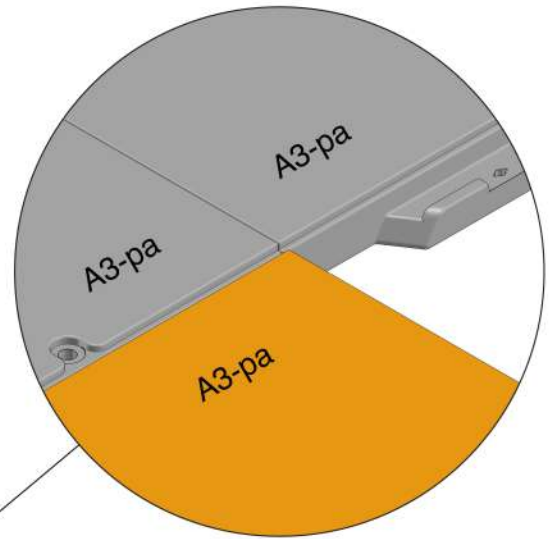
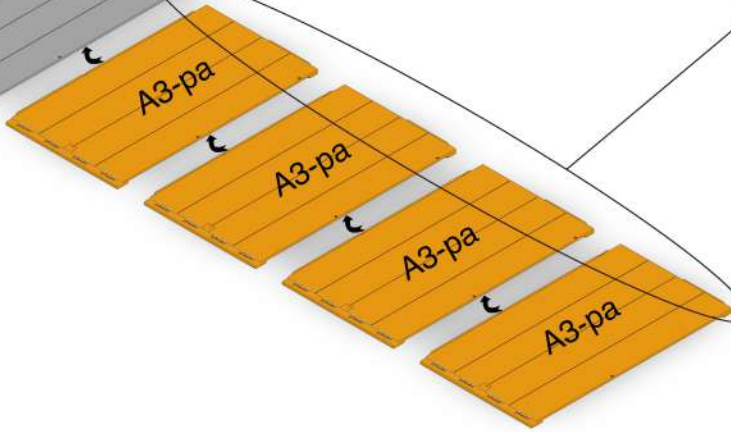
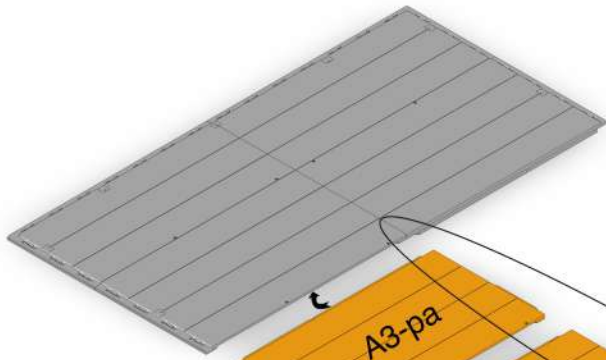

4



A4-pa x1



A5-pa x1



E58-pa x25

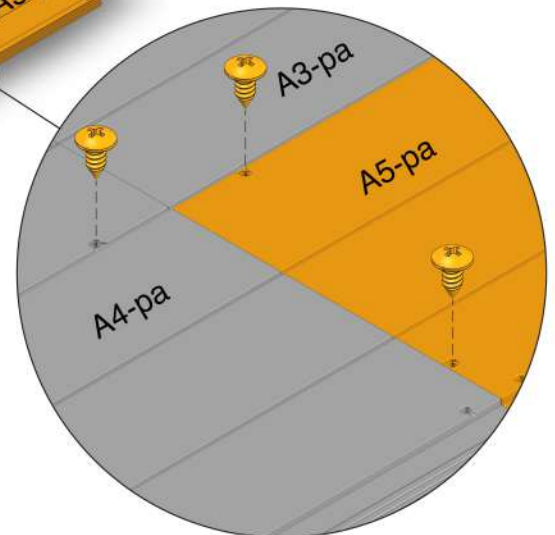
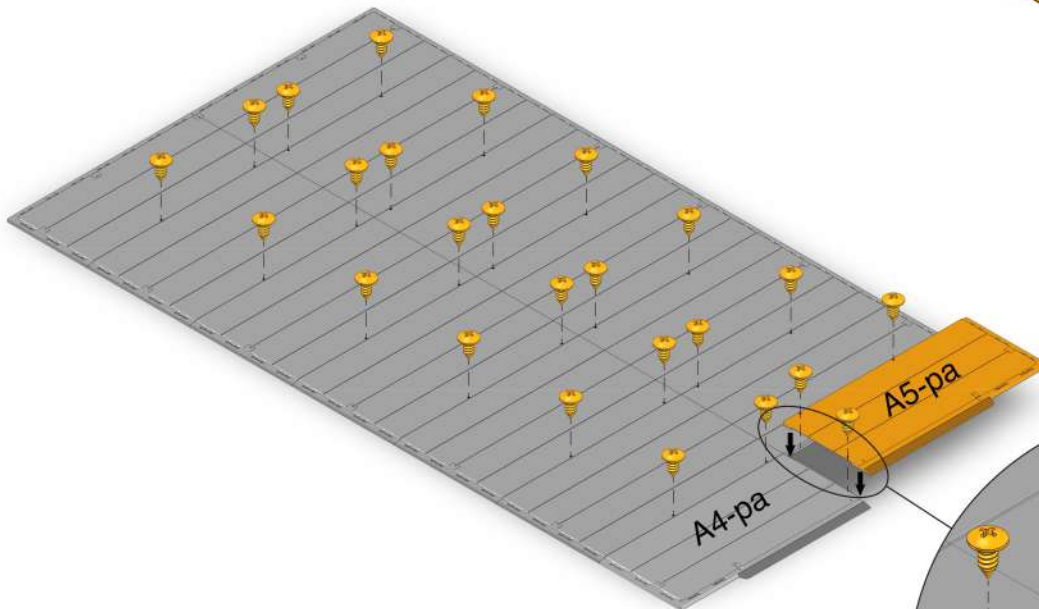
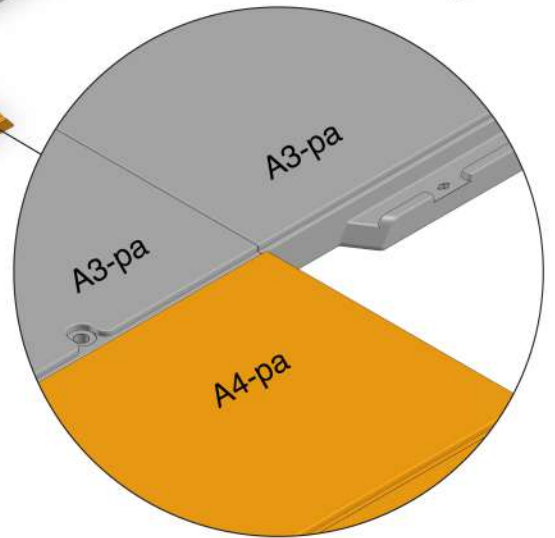
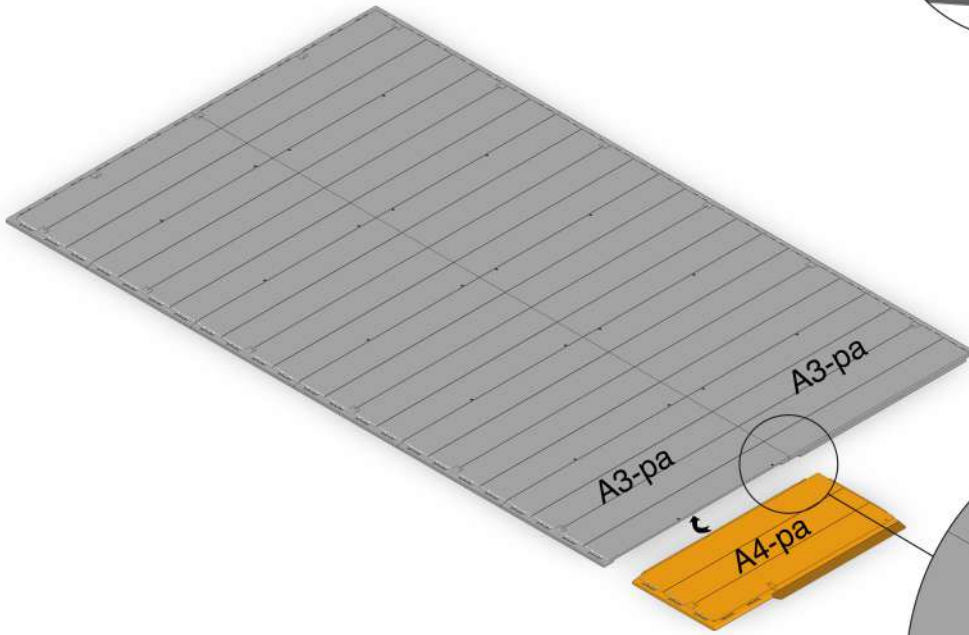
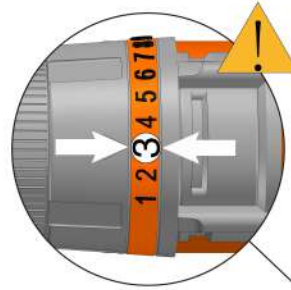

5



A6-pa x1

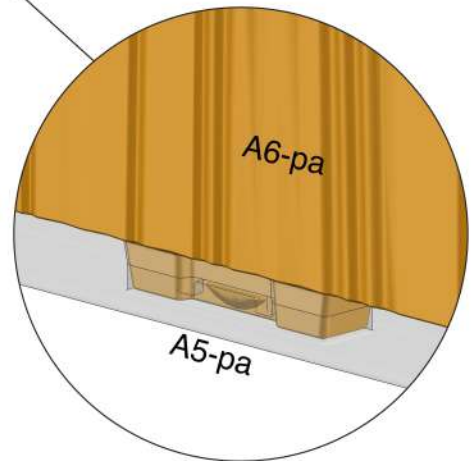
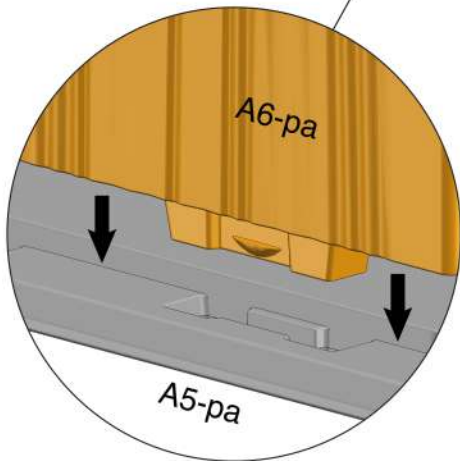
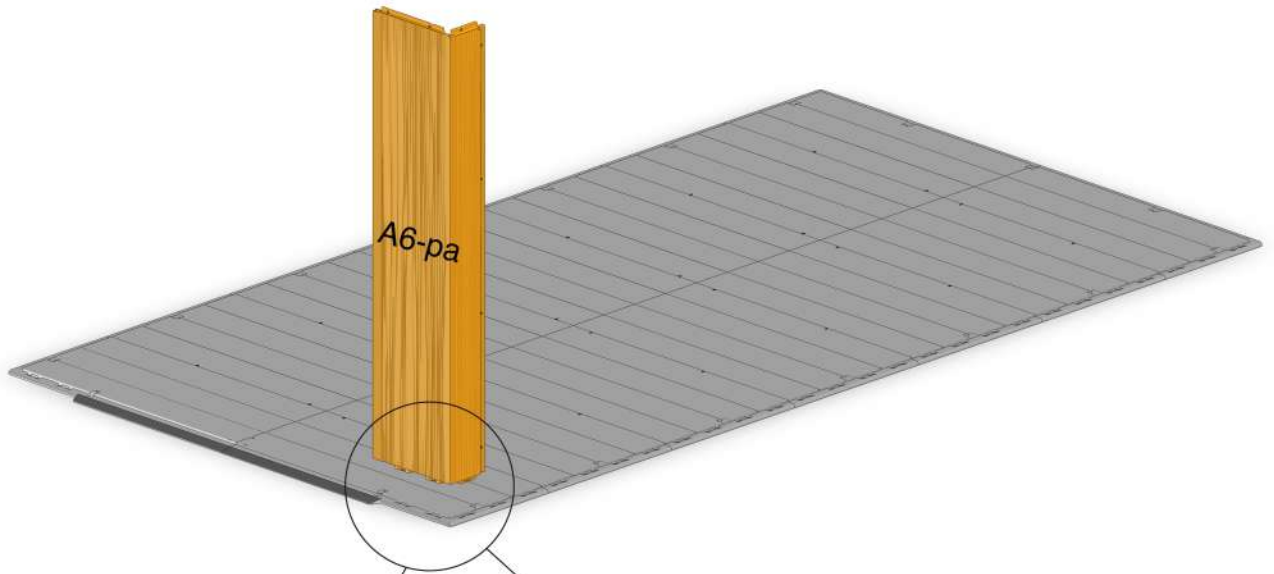
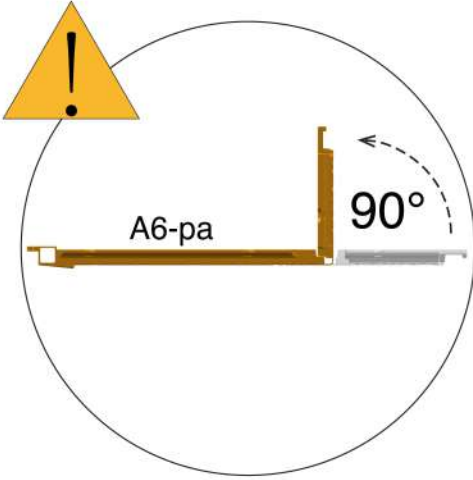
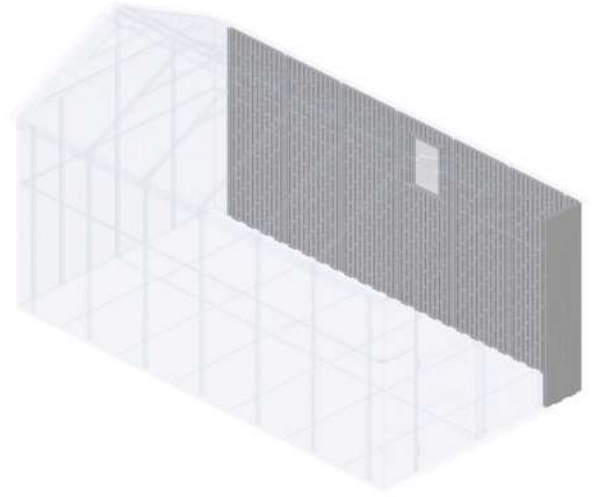

6

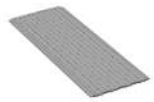

A7-pa x1

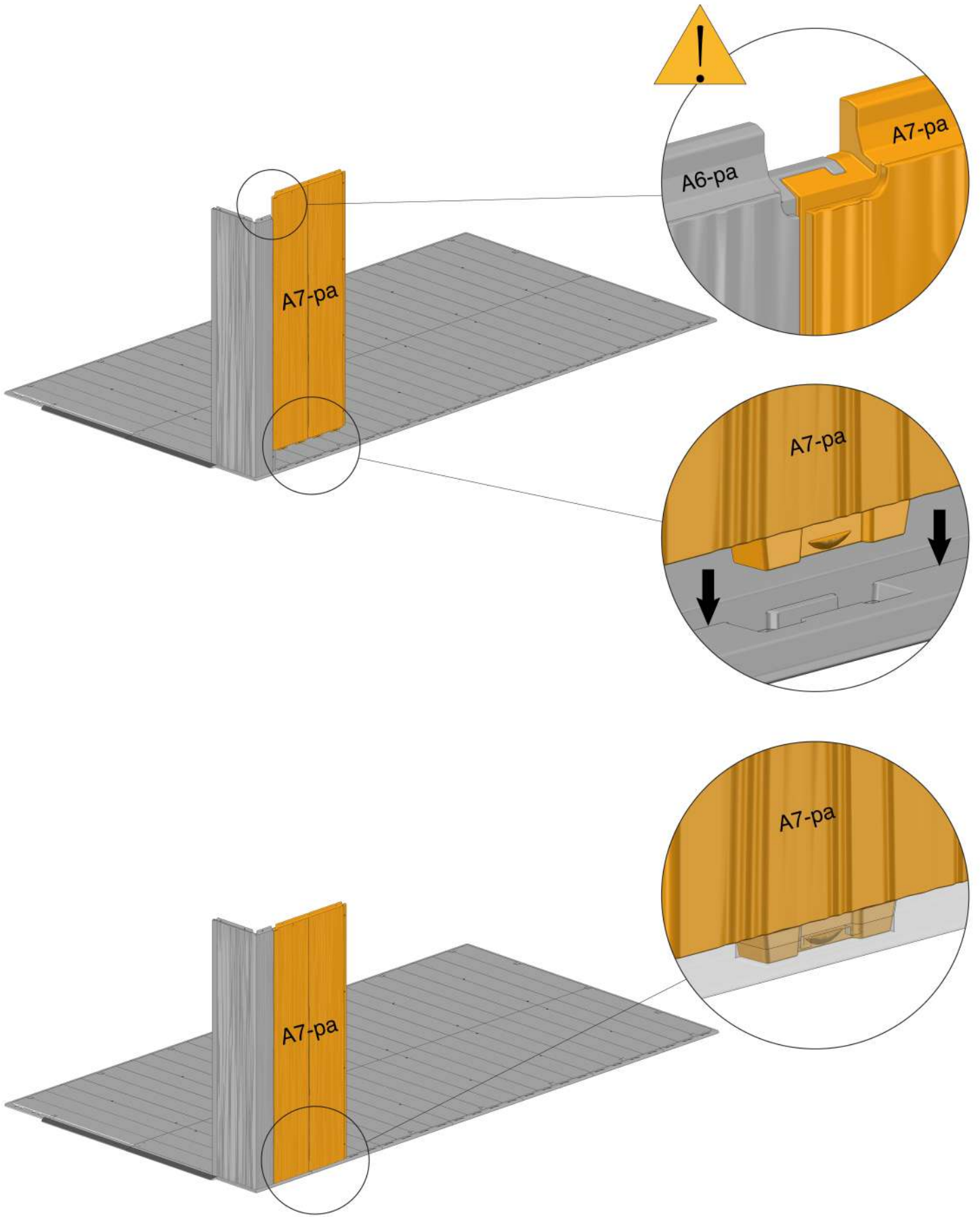

8



A8-pa x1

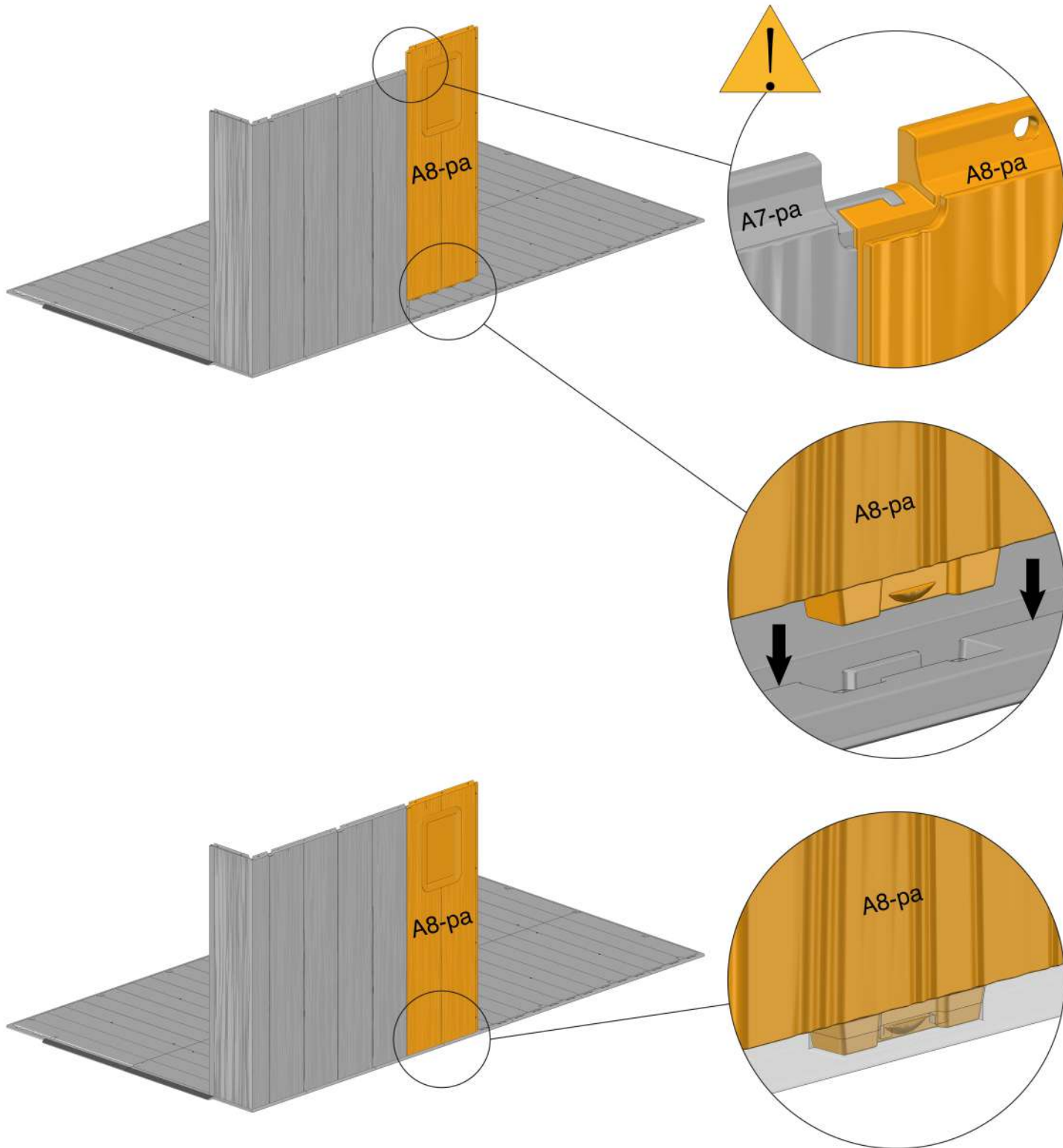

9

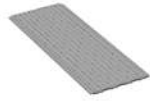

A7-pa x3

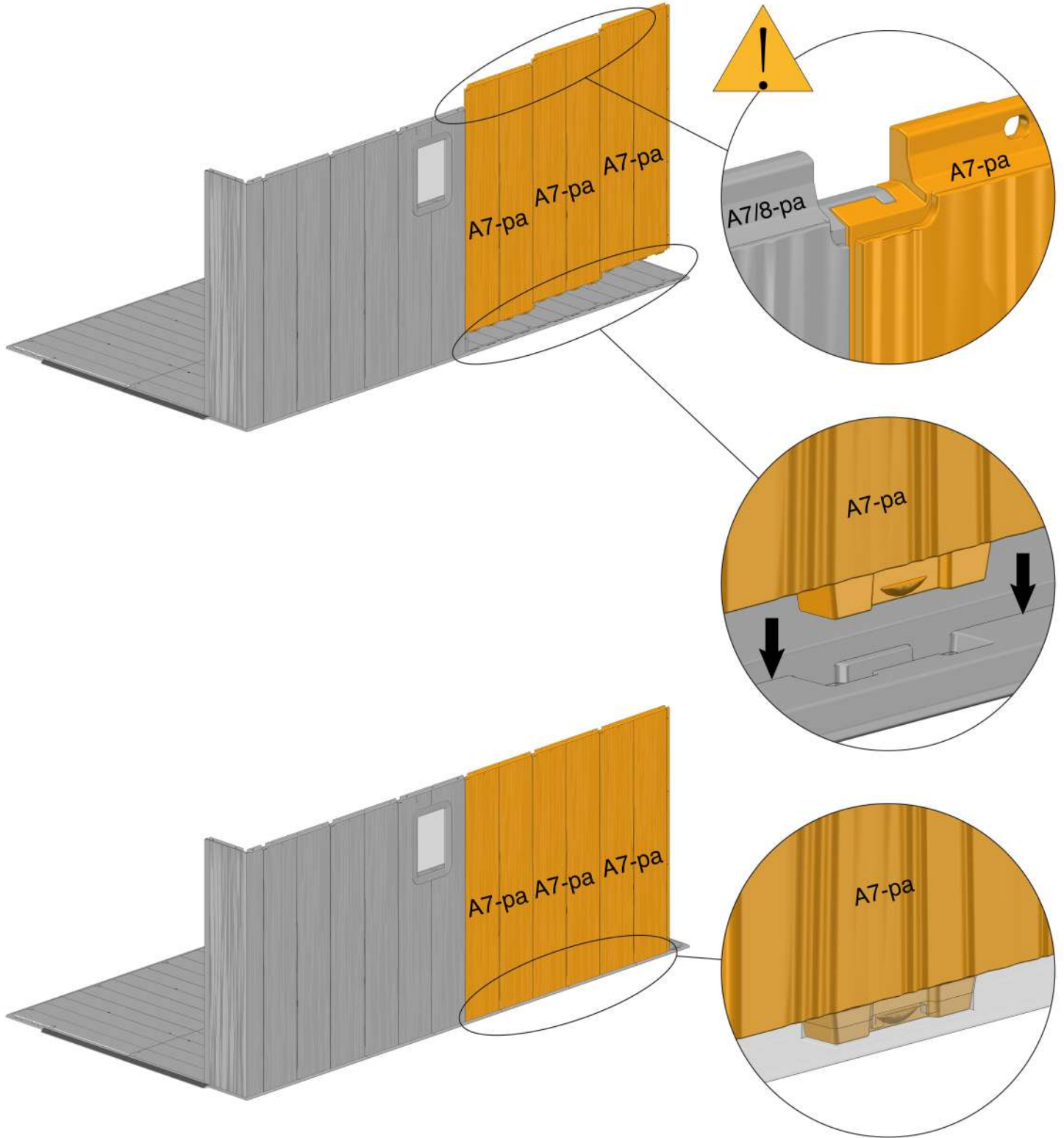

10



A9-pa x1

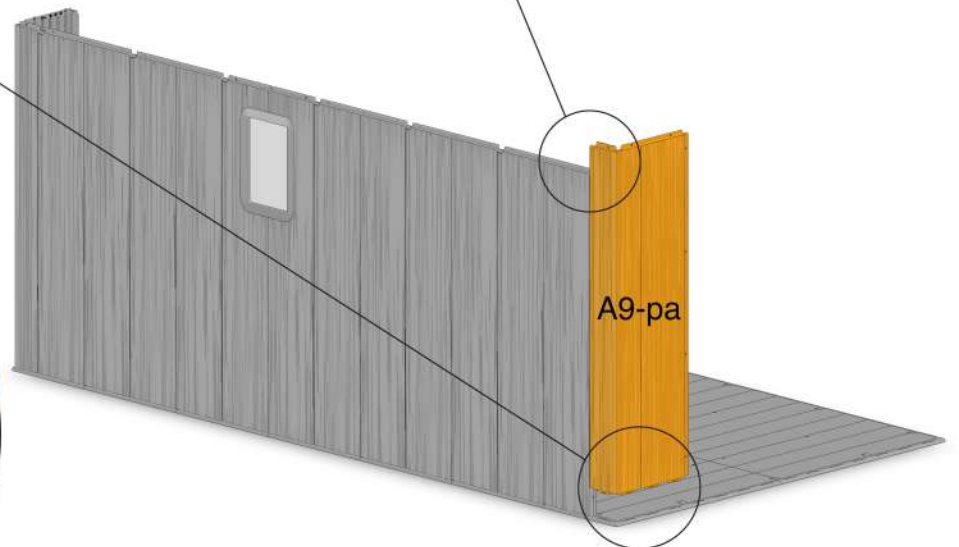
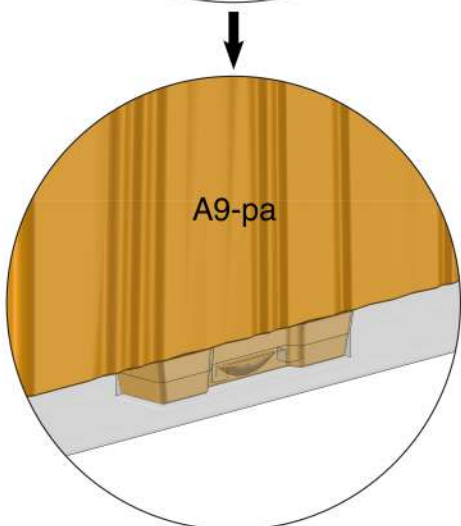
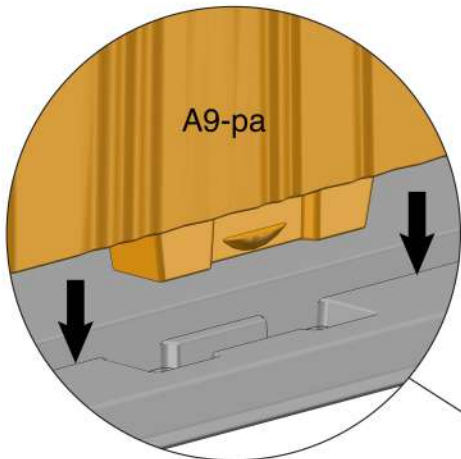
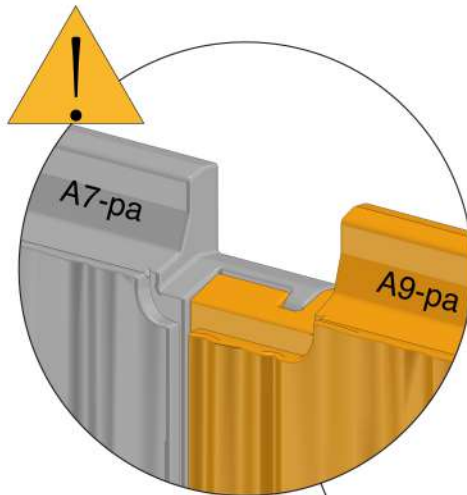
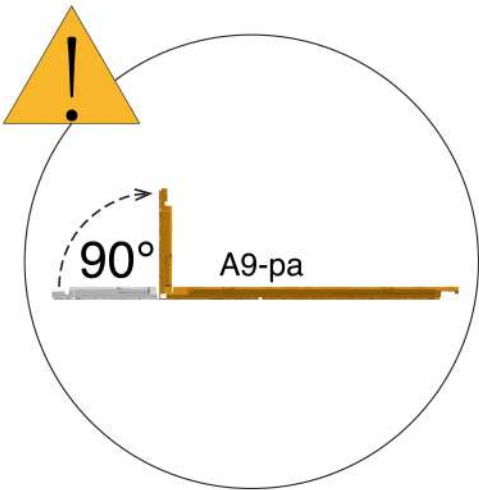
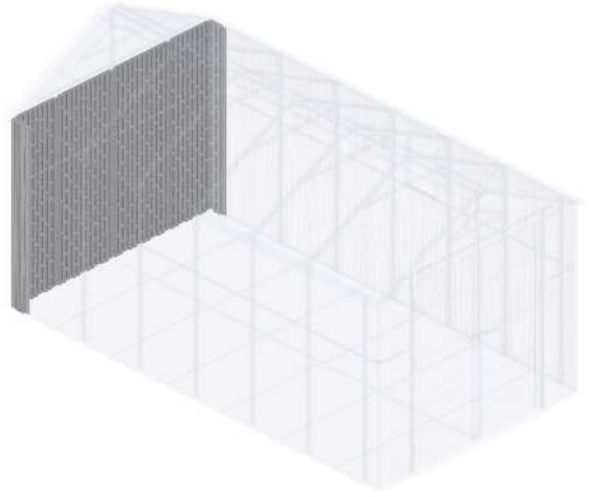

11



A7-pa x2



A10-pa x1

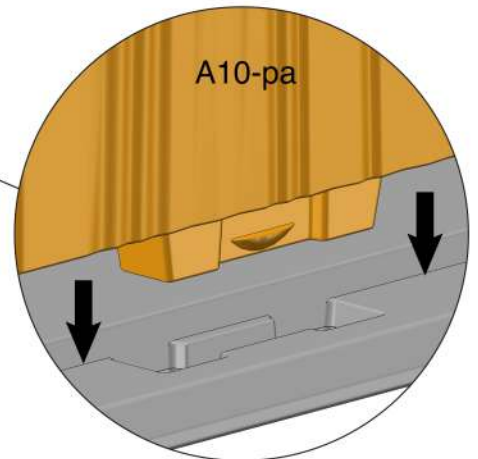
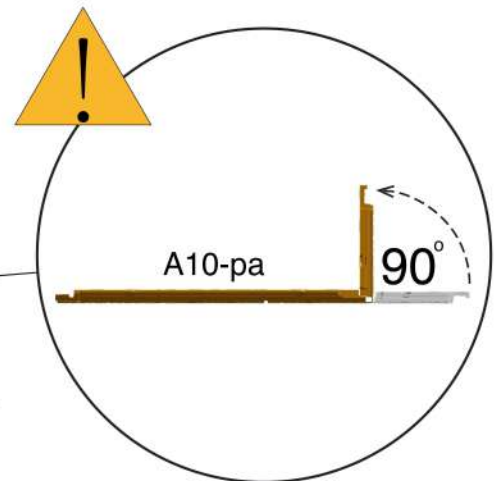
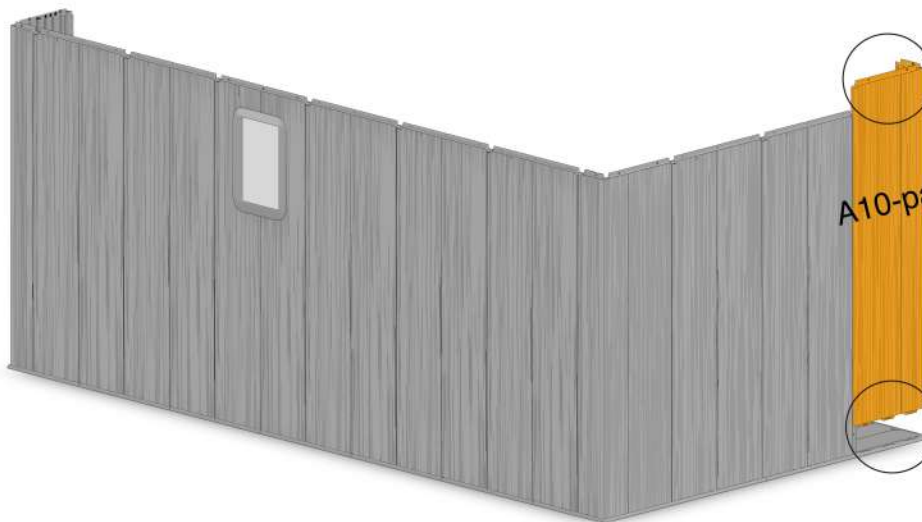
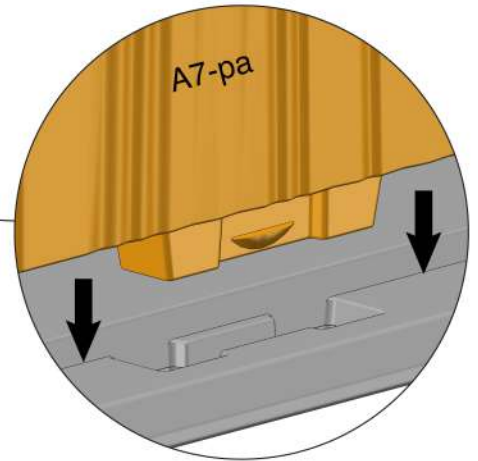
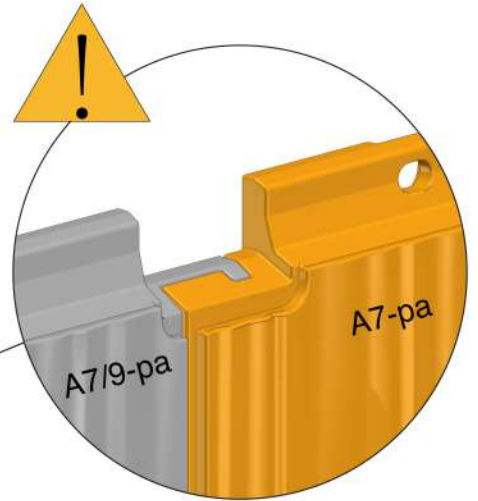
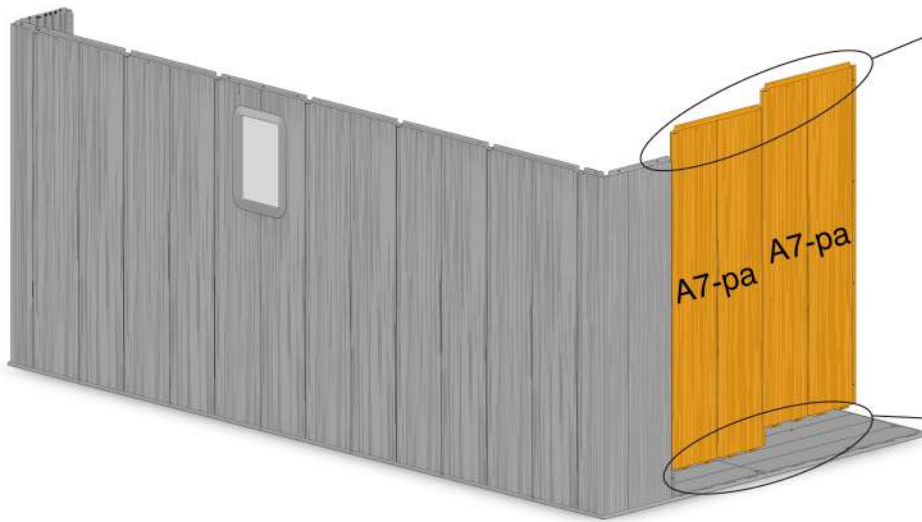

12

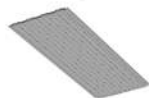

A7-pa x6

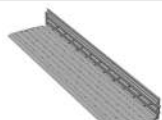

A11-pa x1

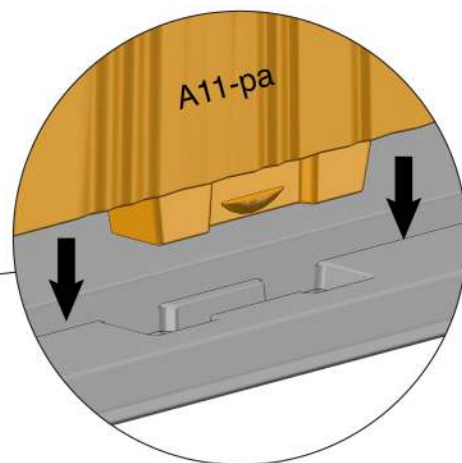
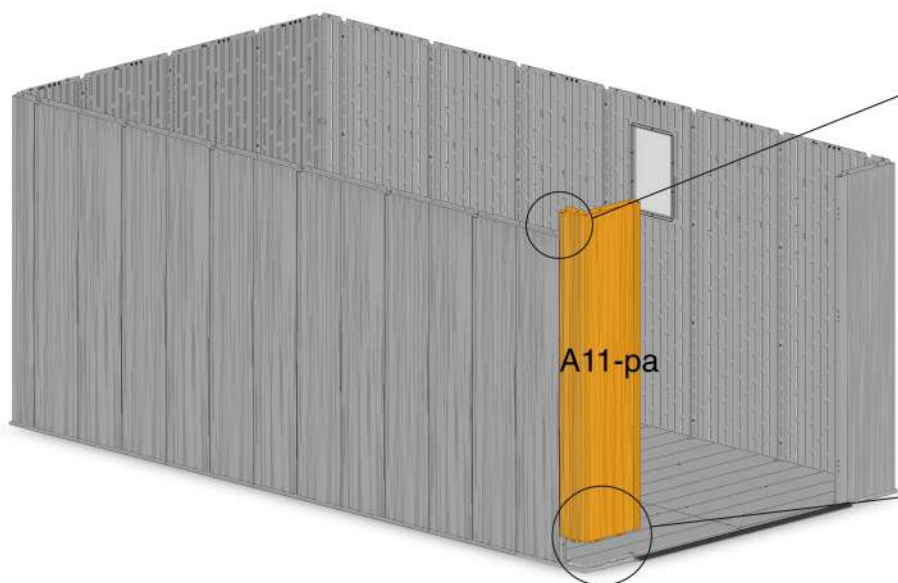
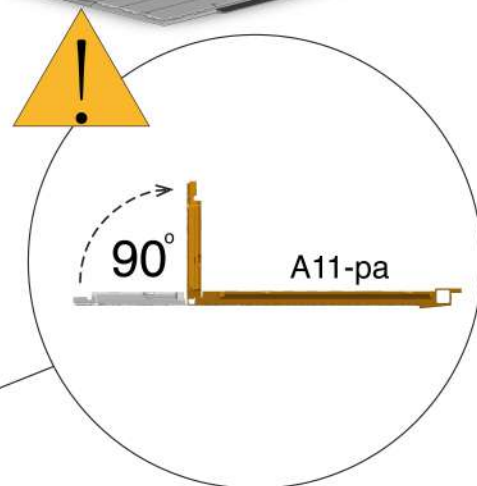
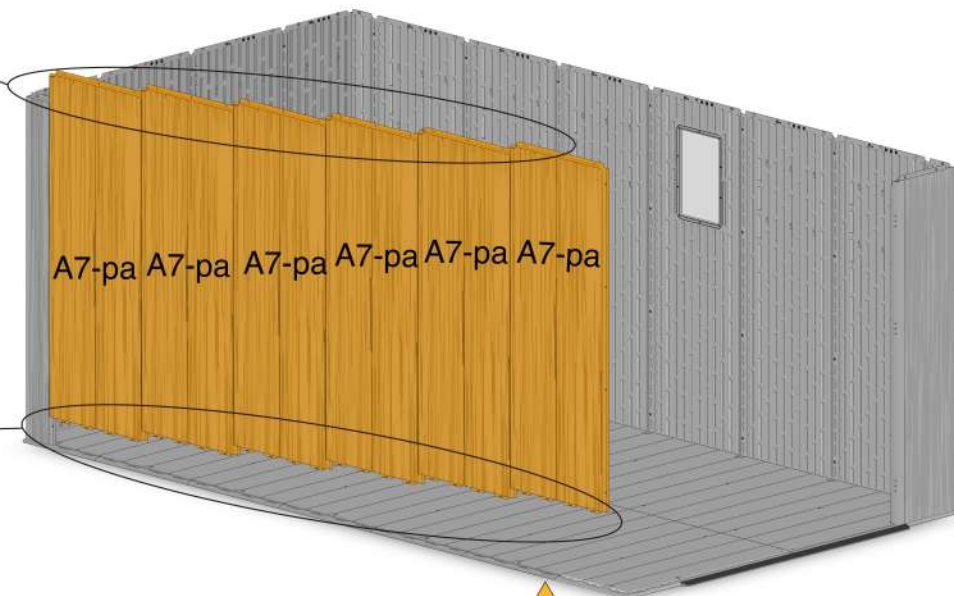
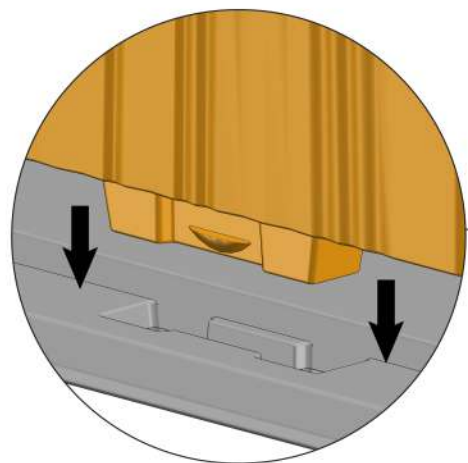
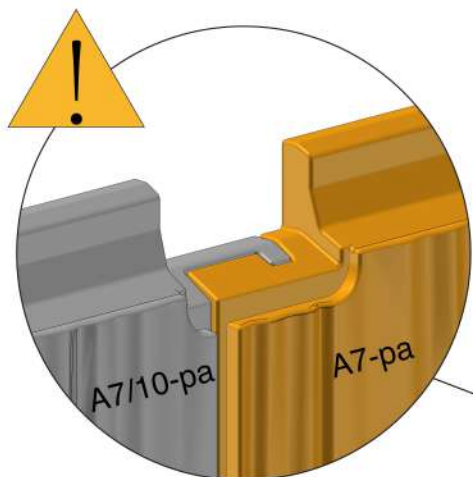
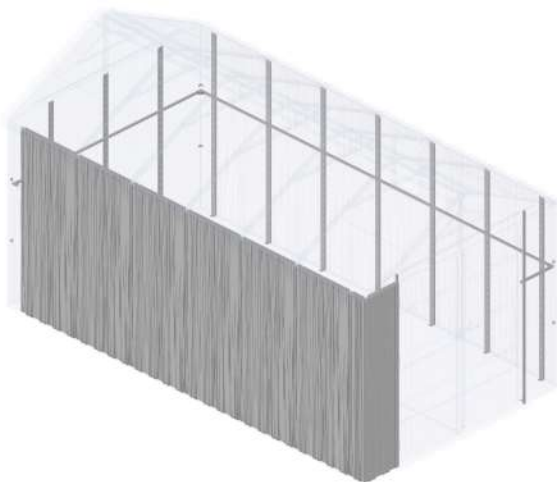

13



A30-pa x10



E54-pa x30

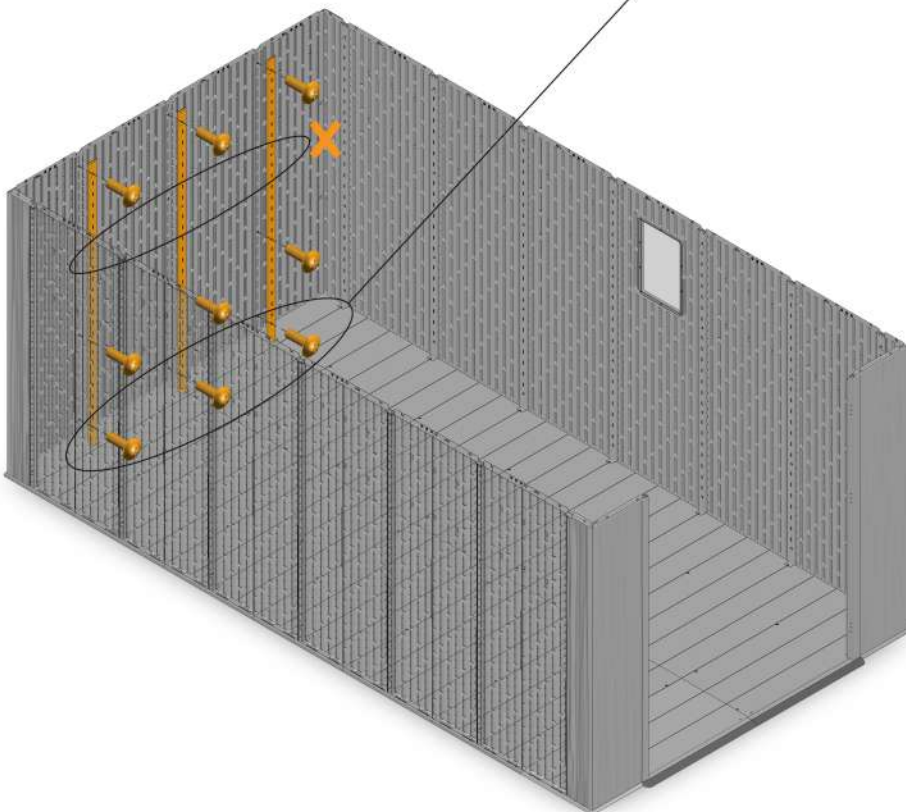
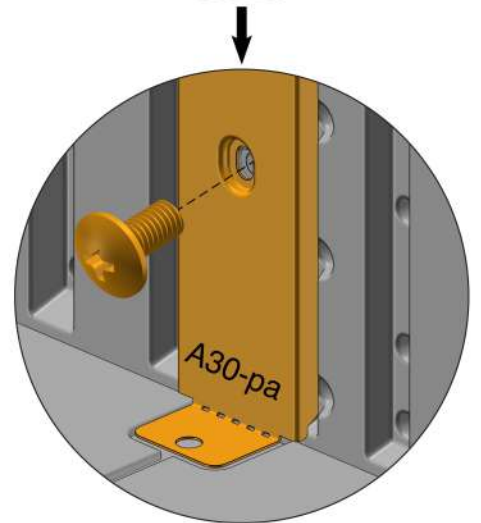
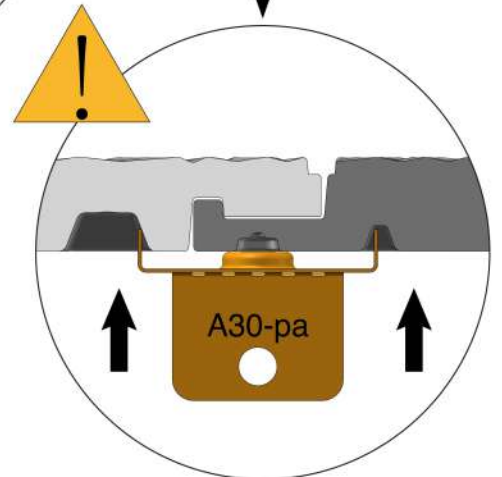
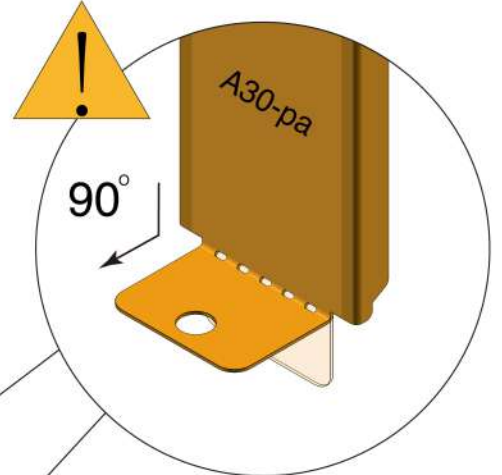
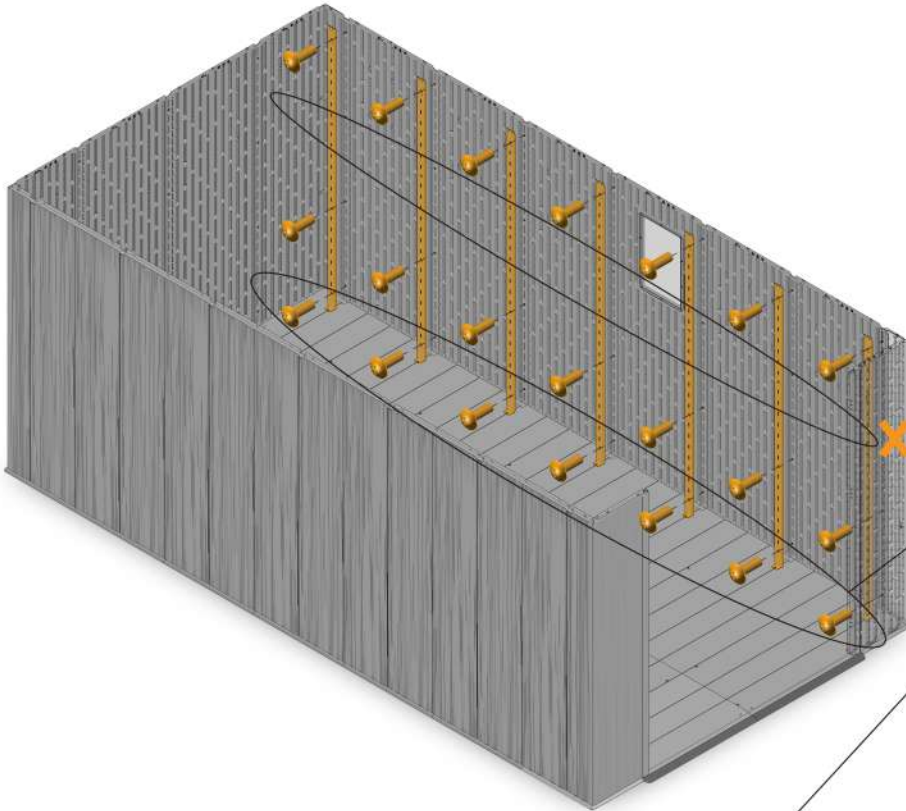

14



A30-pa x7



E54-pa x21

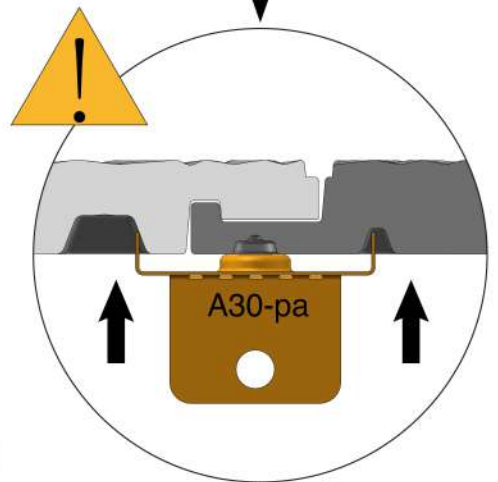
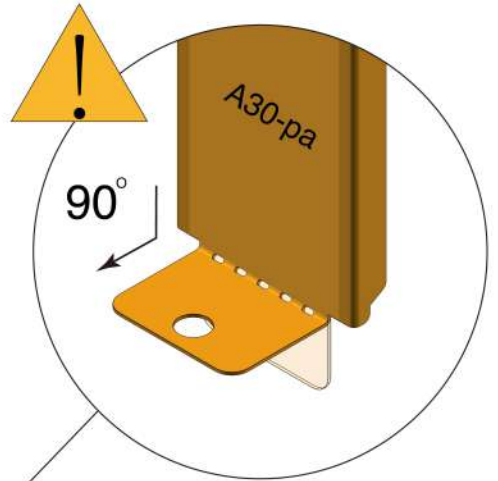
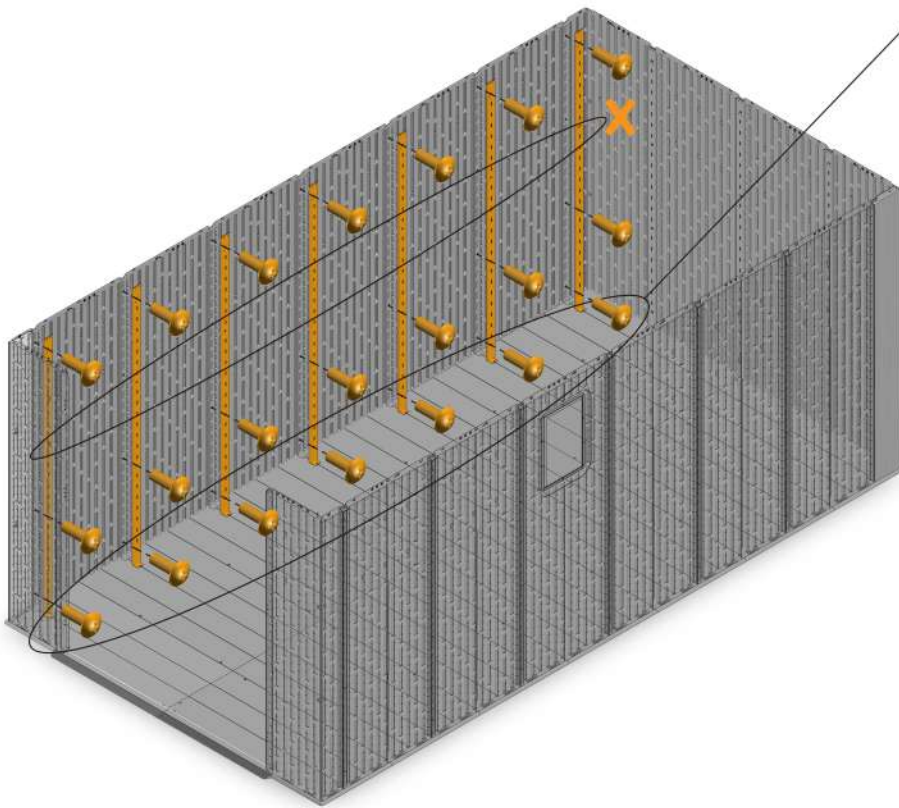

15

A46-pa x1

D47-pa x2

E47a-pa x2

E55-pa x17

E51-pa x8

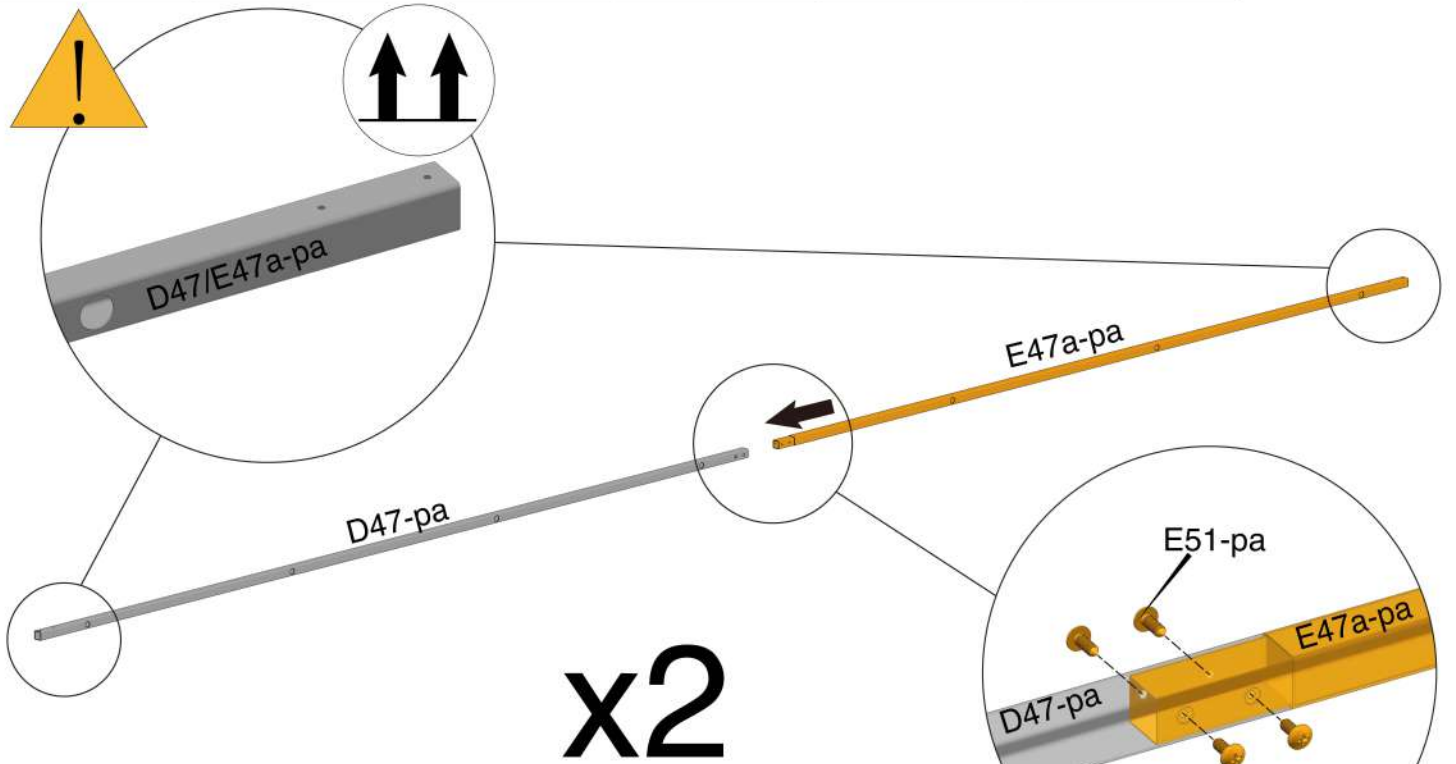
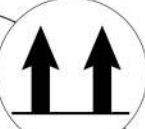

x2

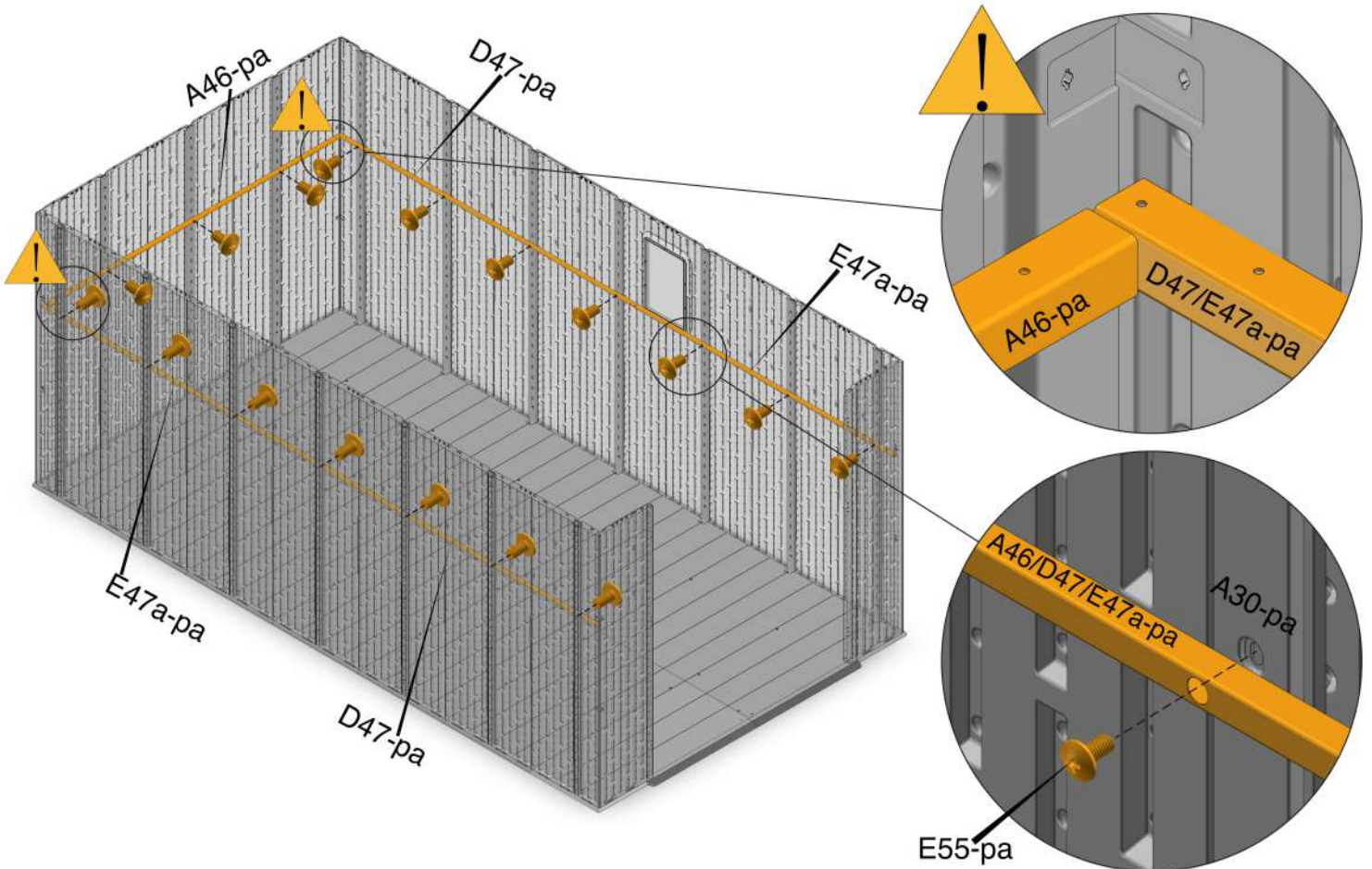

16



Ab-4 x4



E51-pa x10

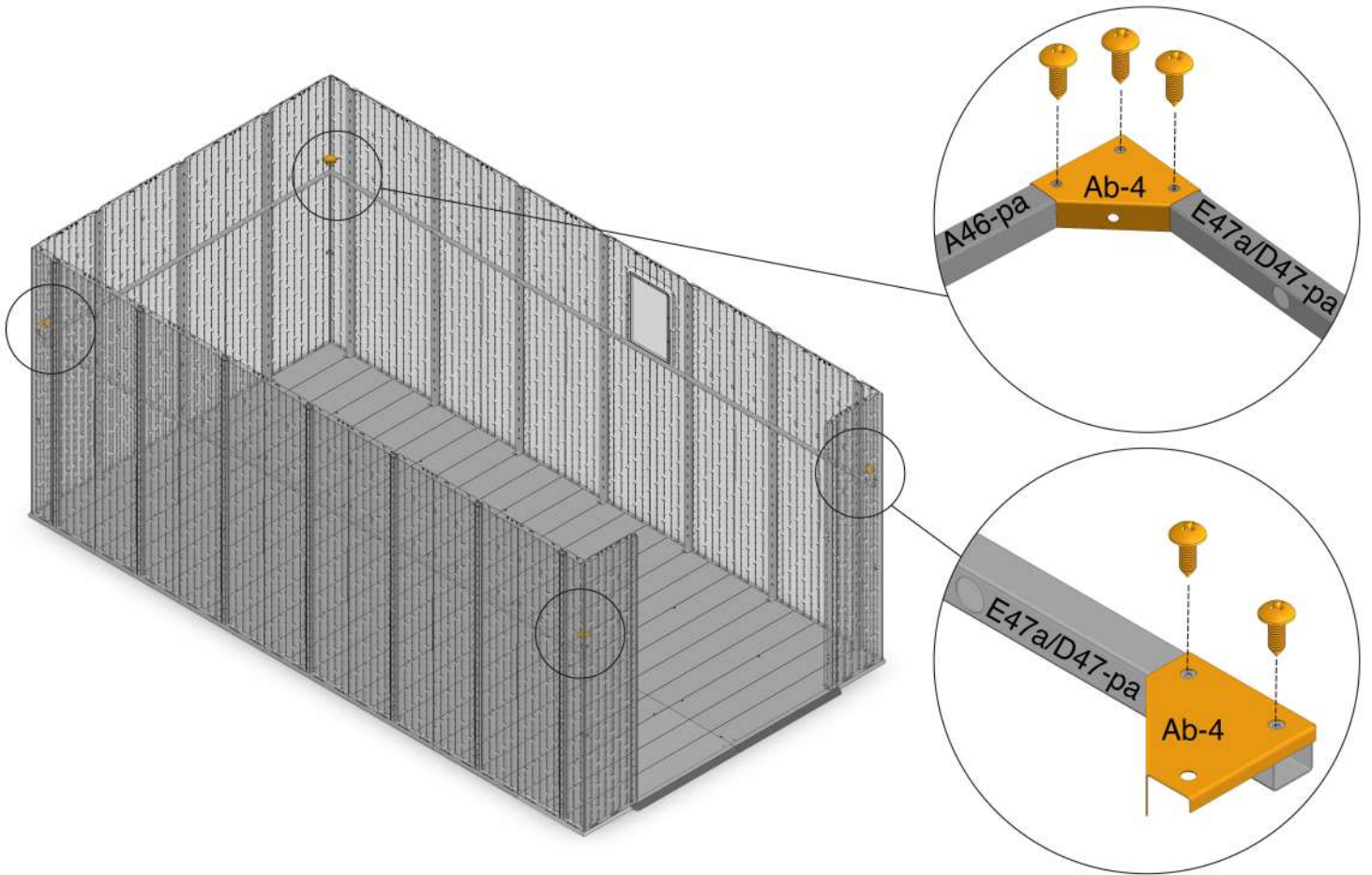

17

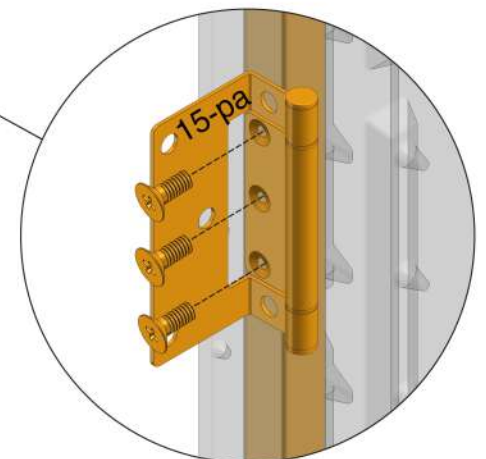
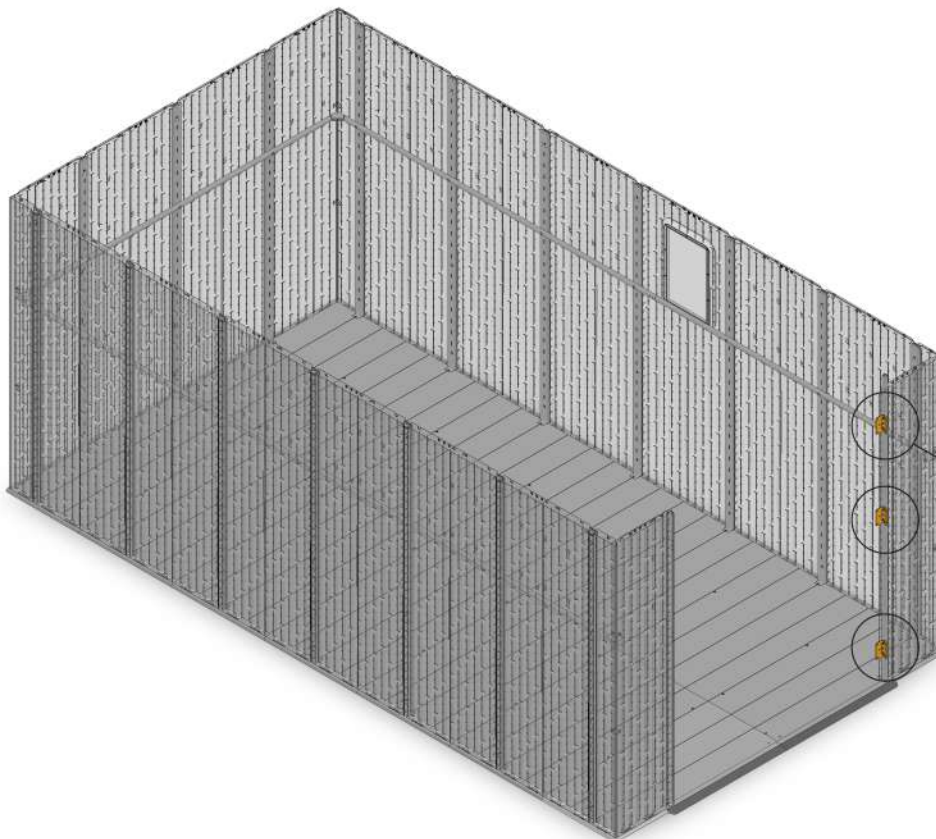
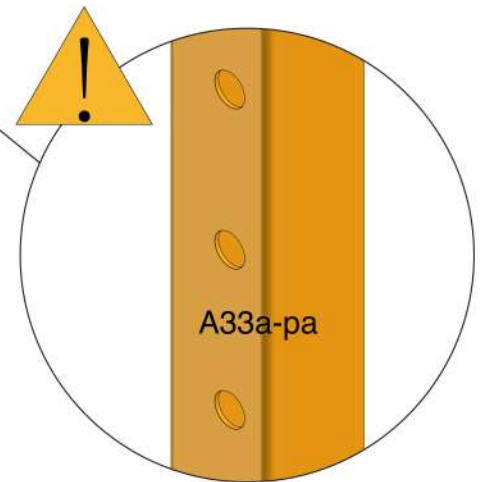
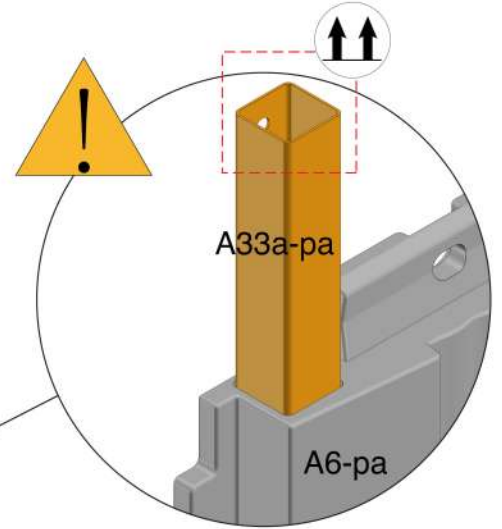
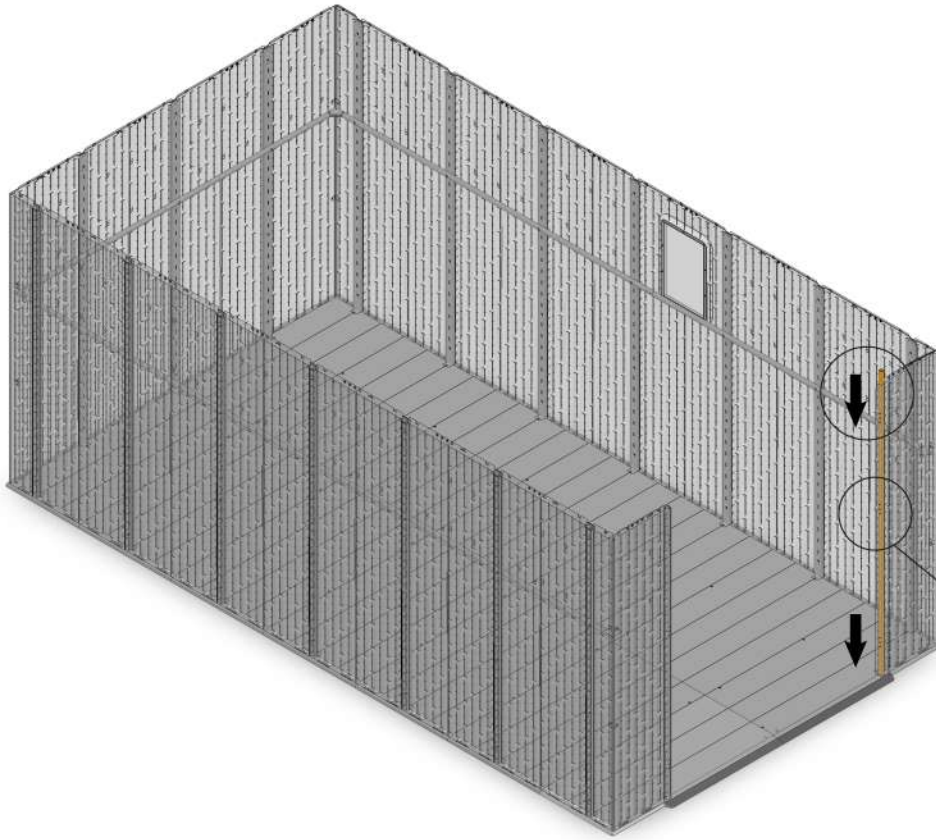
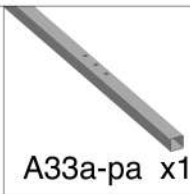

18

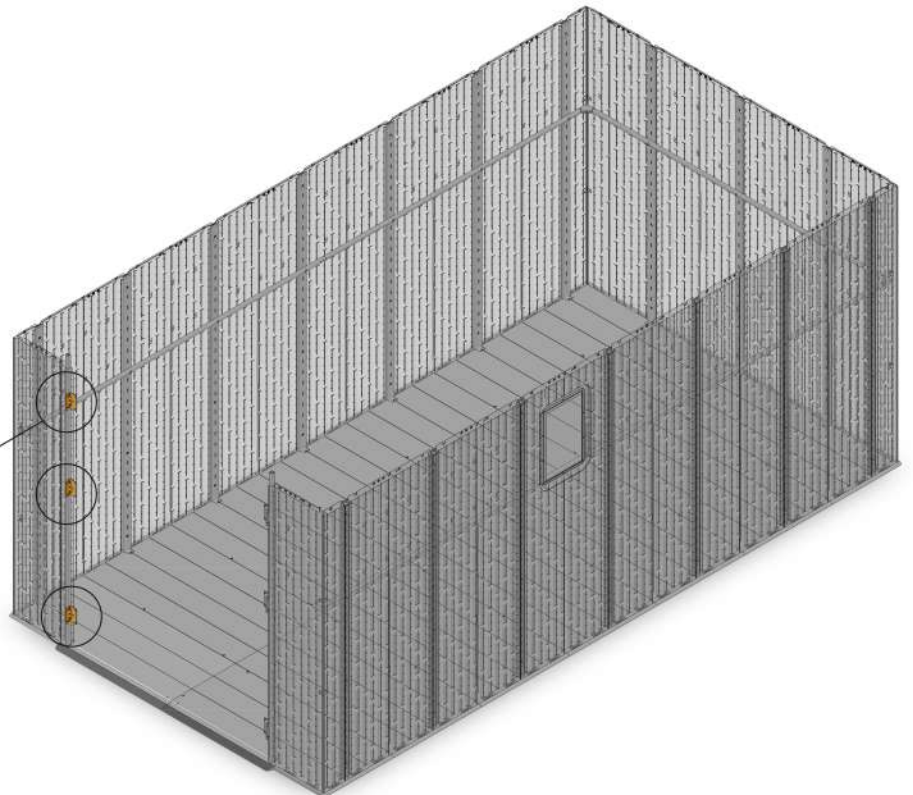
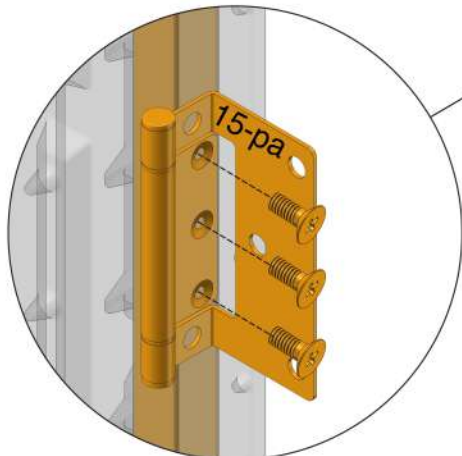
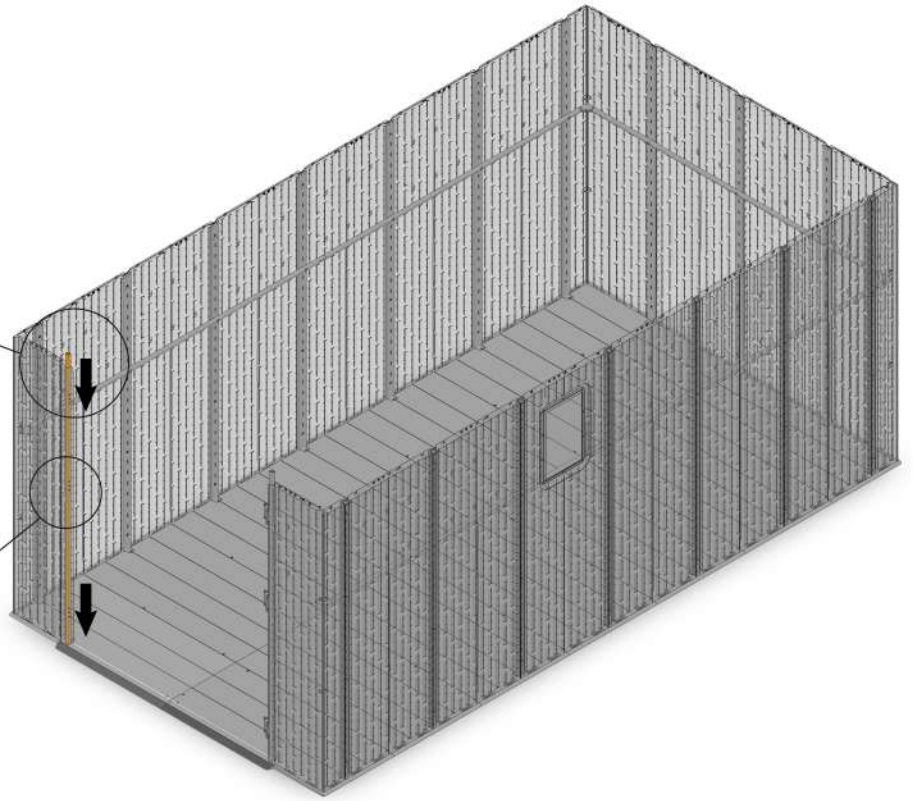
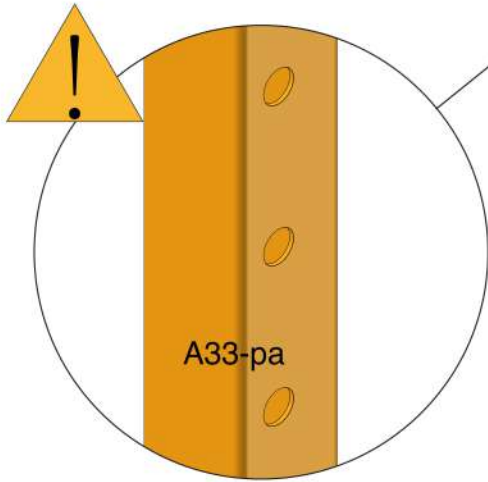
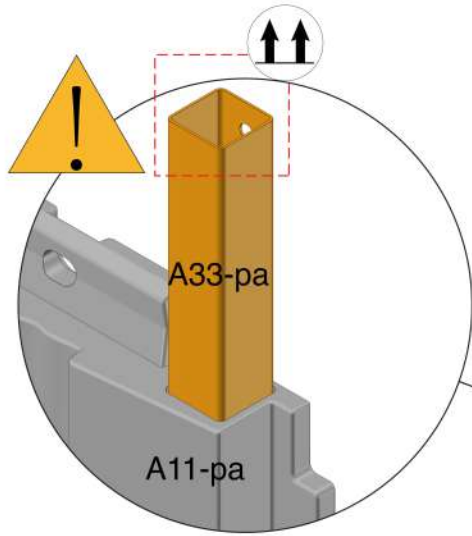

19



A48-pa x2



21-pa x2



16-pa x10



E51-pa x2



E52-pa x4



E58-pa x16

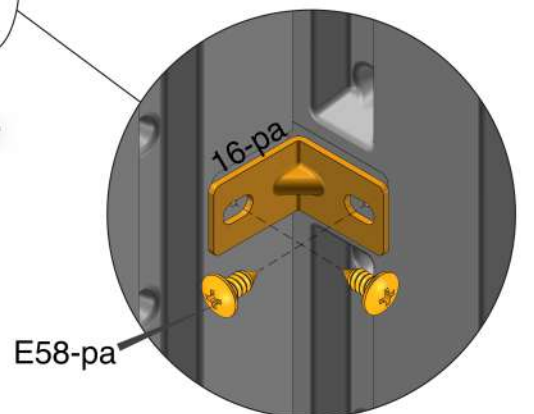
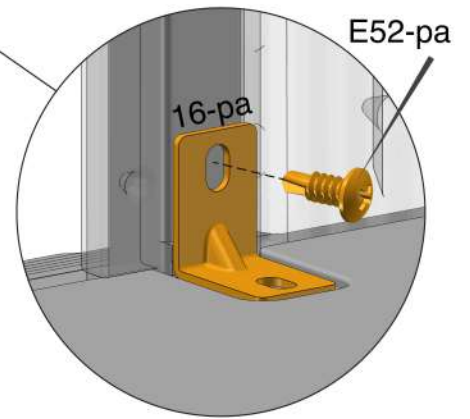
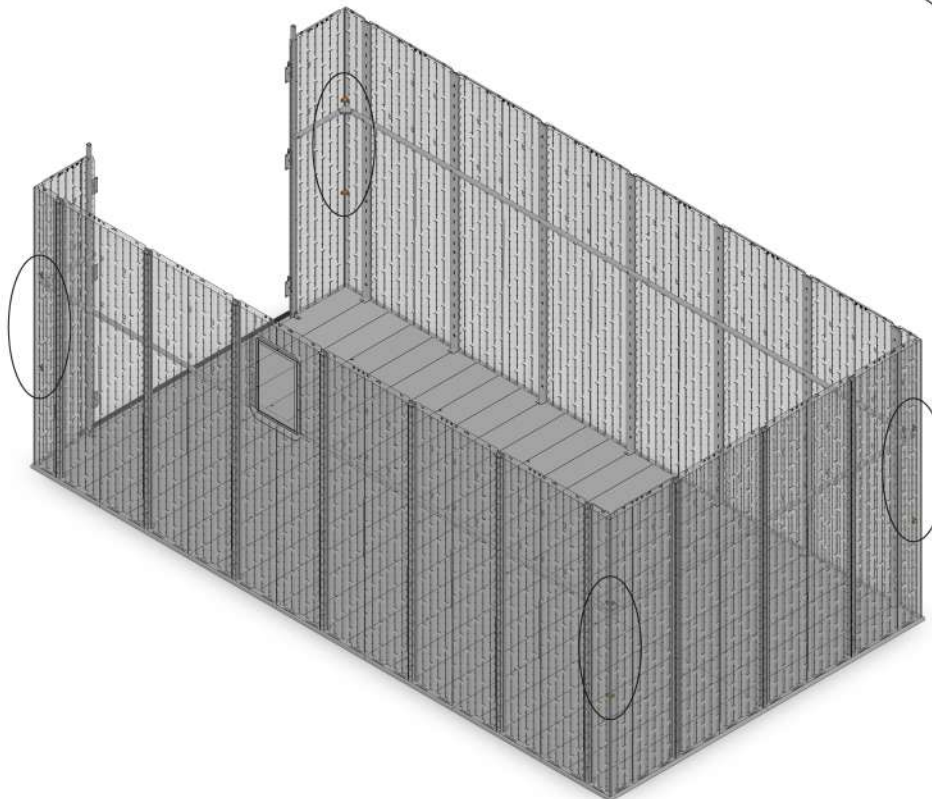
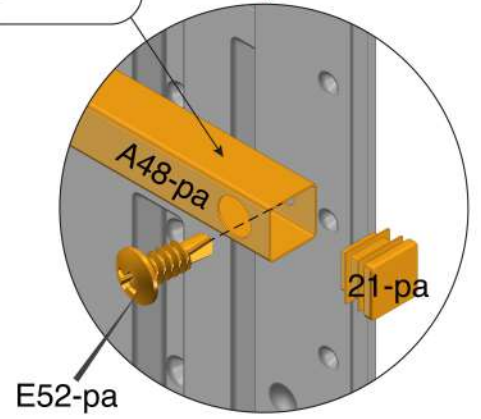
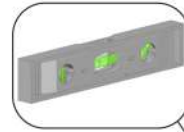
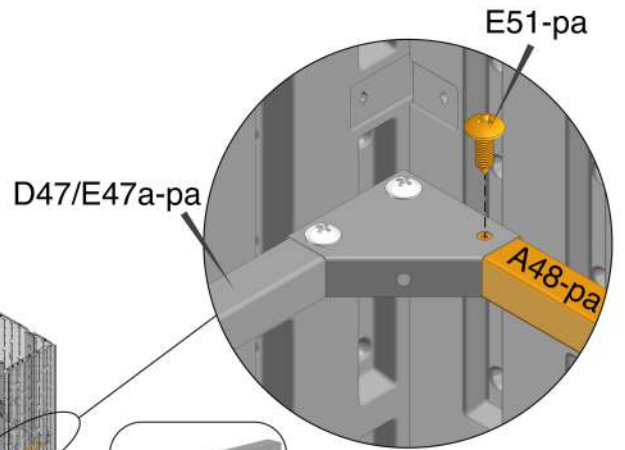
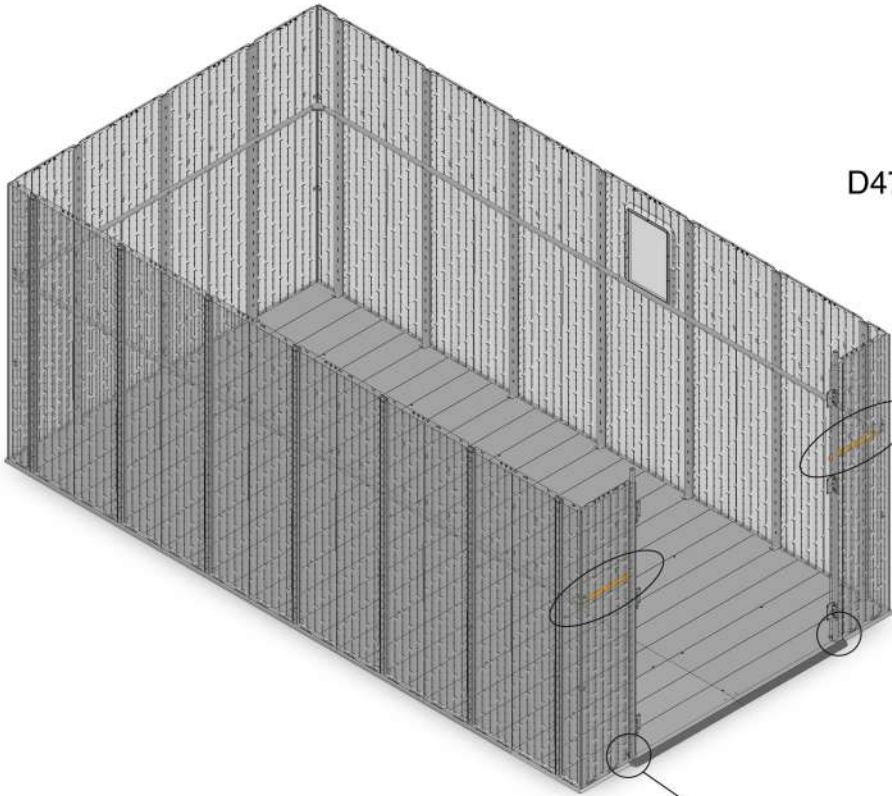

20



A43-pa x10



E58-pa x40

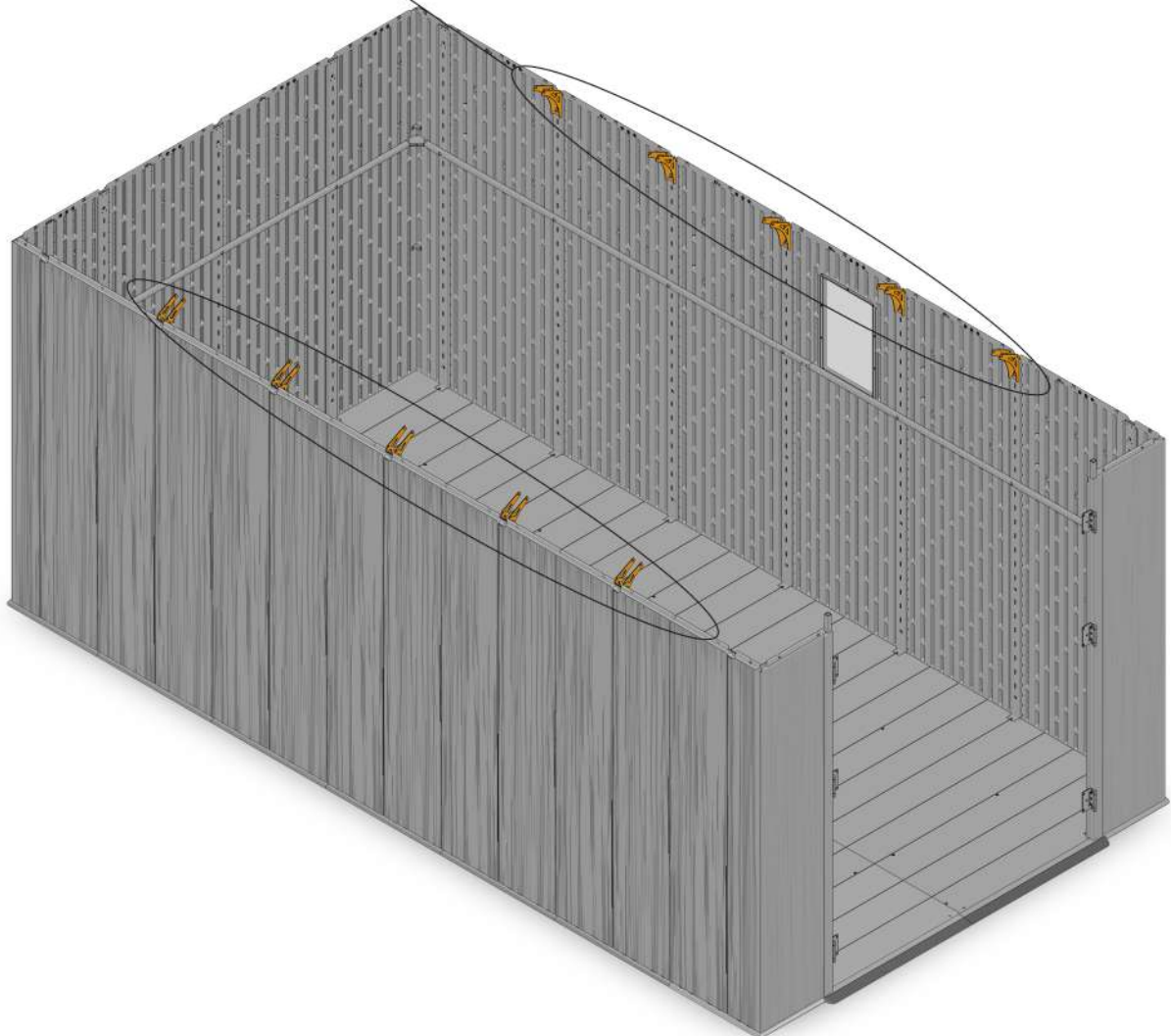
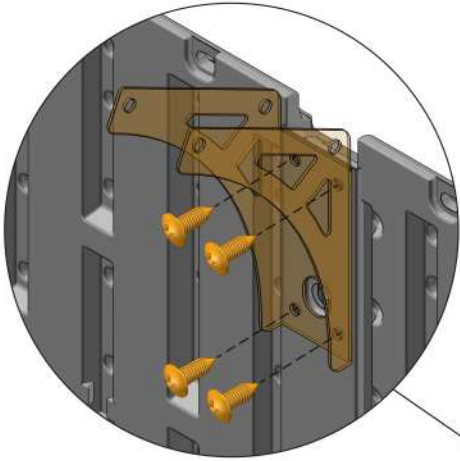
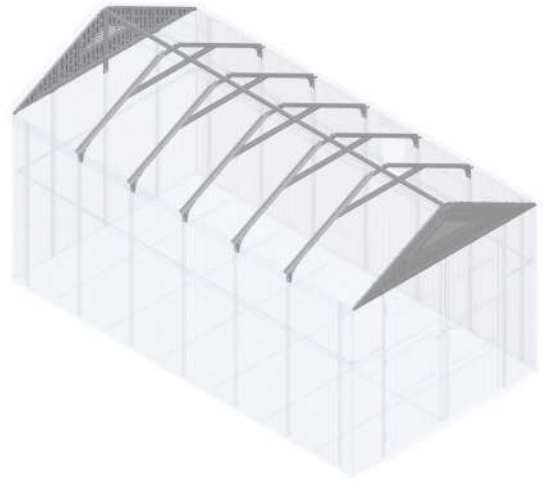

21

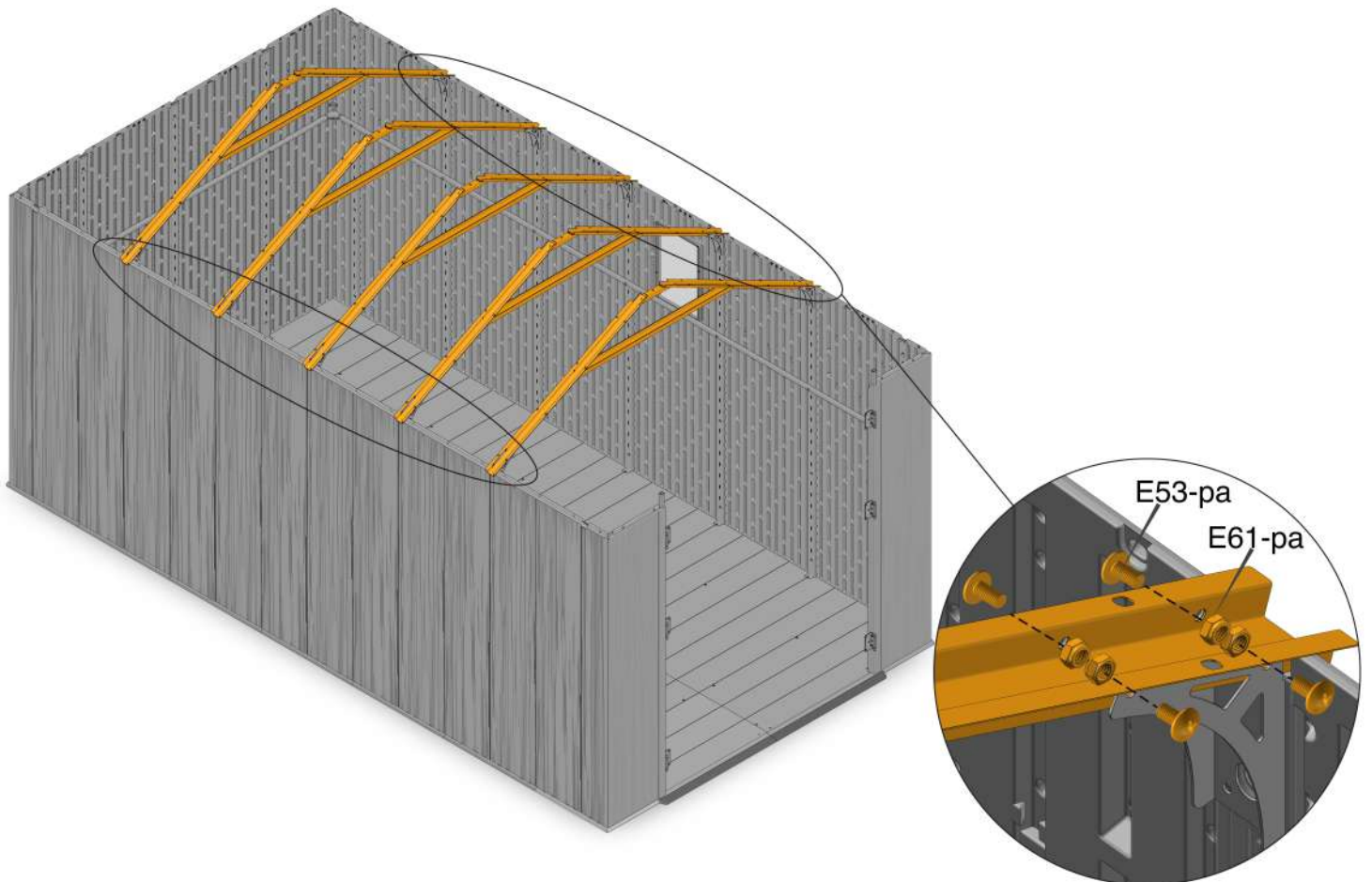
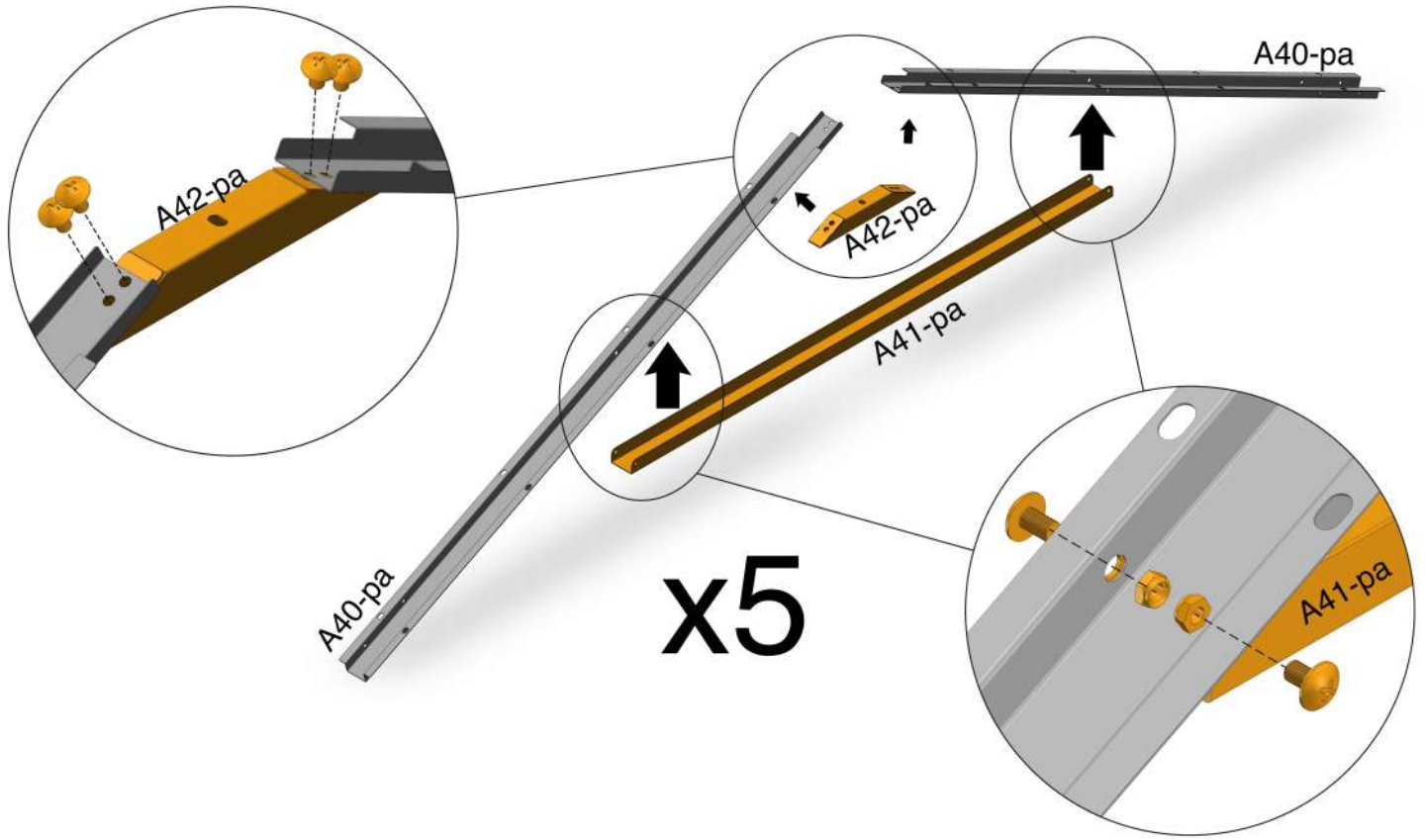
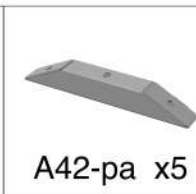
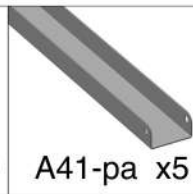
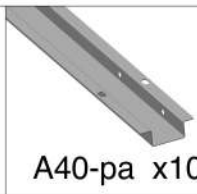

22



A12-pa x1



A13-pa x1



A24-pa x1



E54-pa x3



E51-pa x6

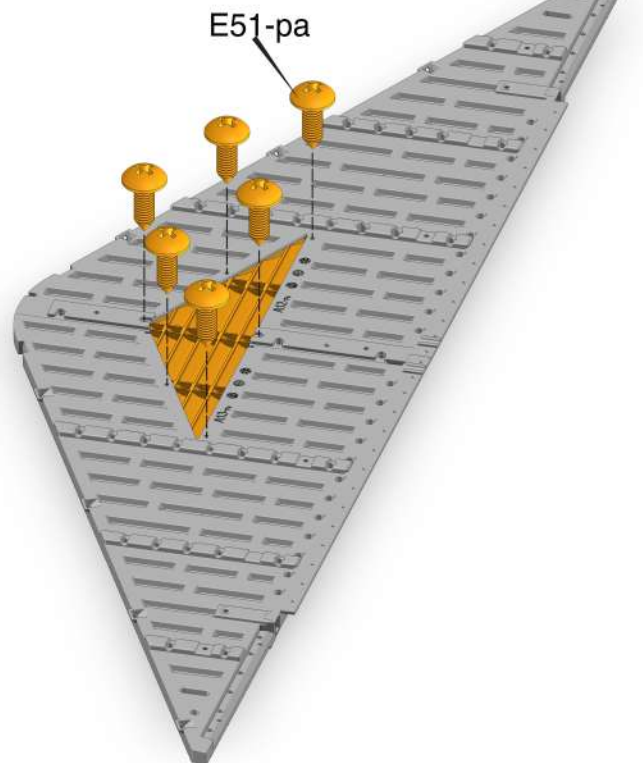
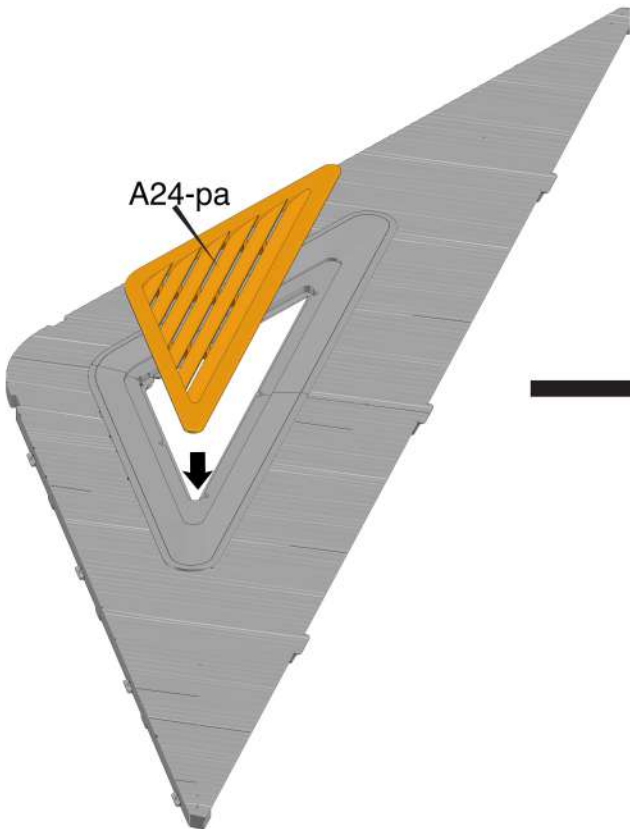
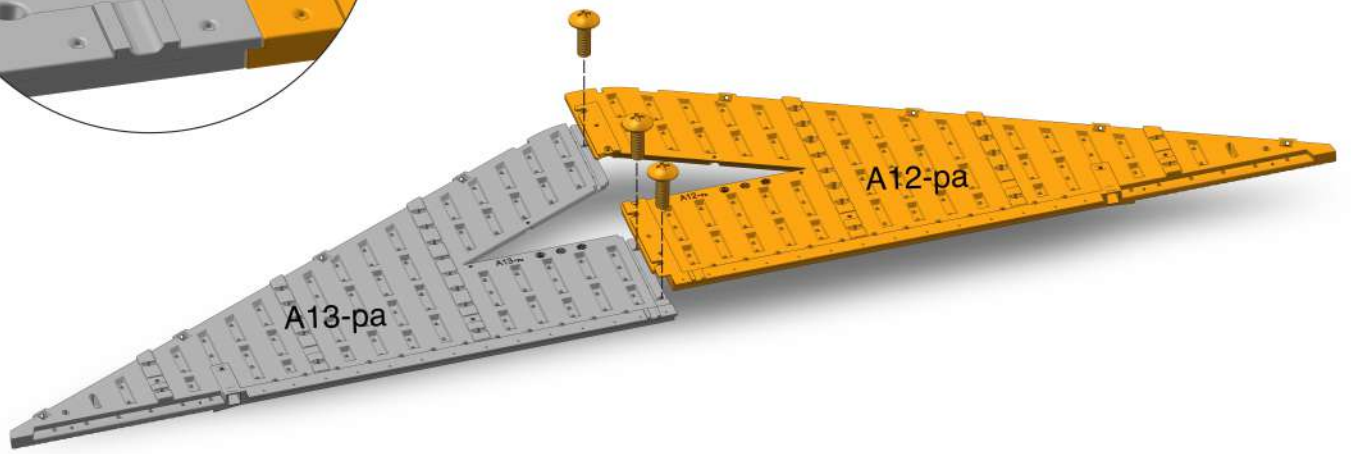
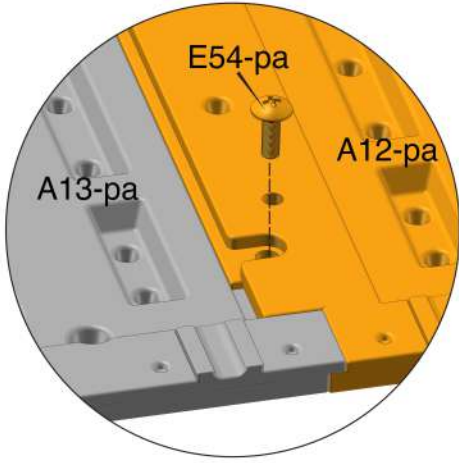

23

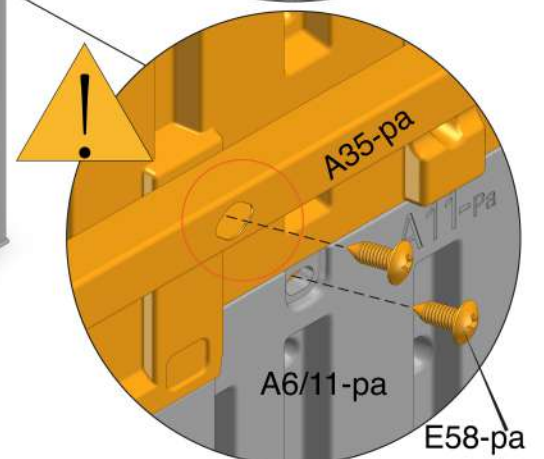
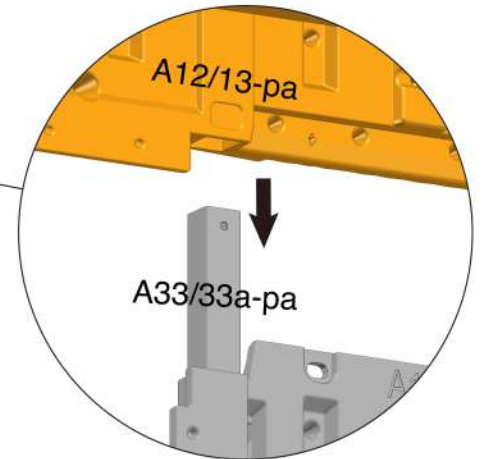
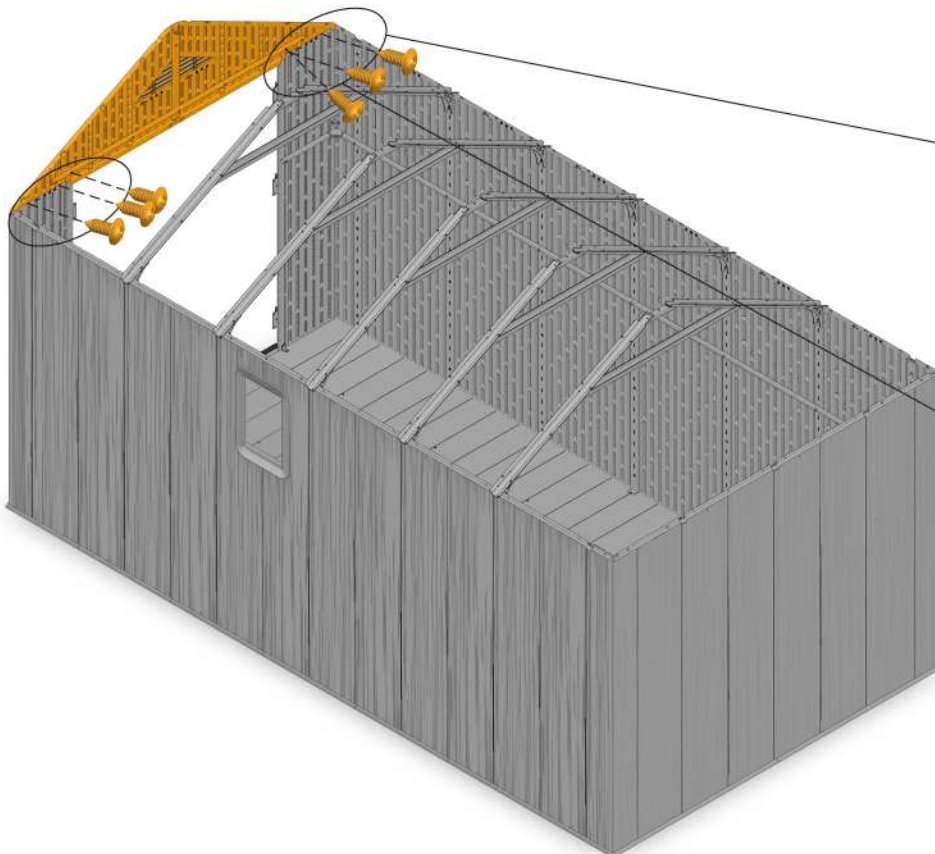
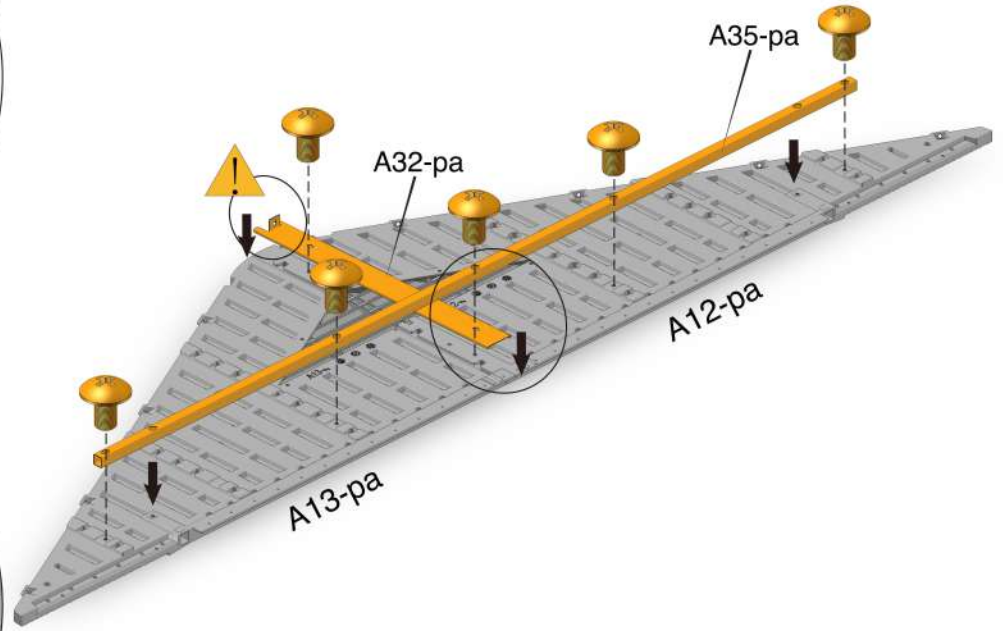
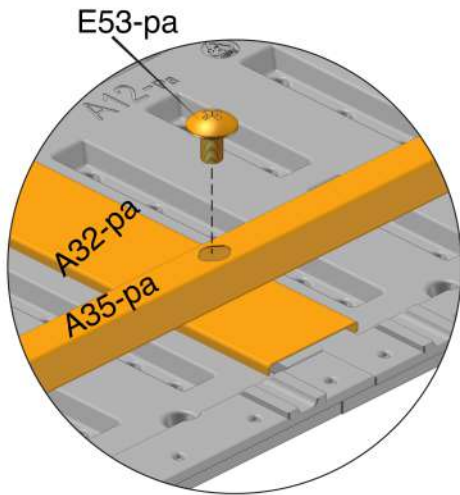
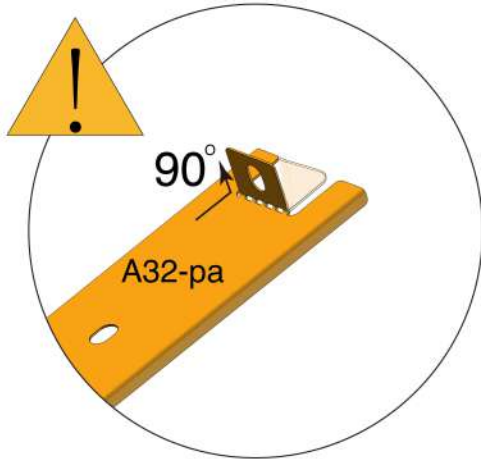

24



A14-pa x1



A15-pa x1



A24-pa x1



E54-pa x3



E51-pa x6

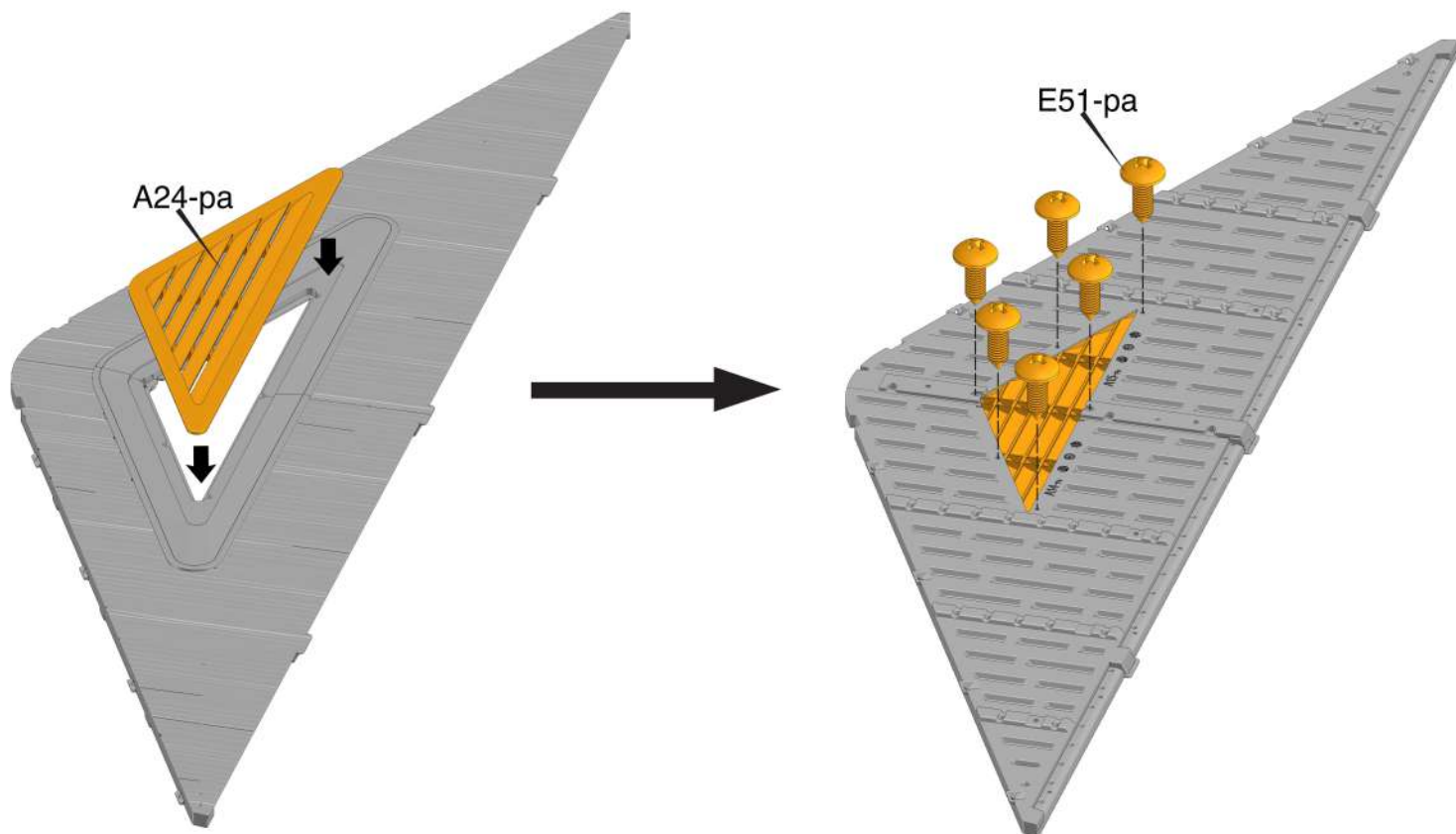
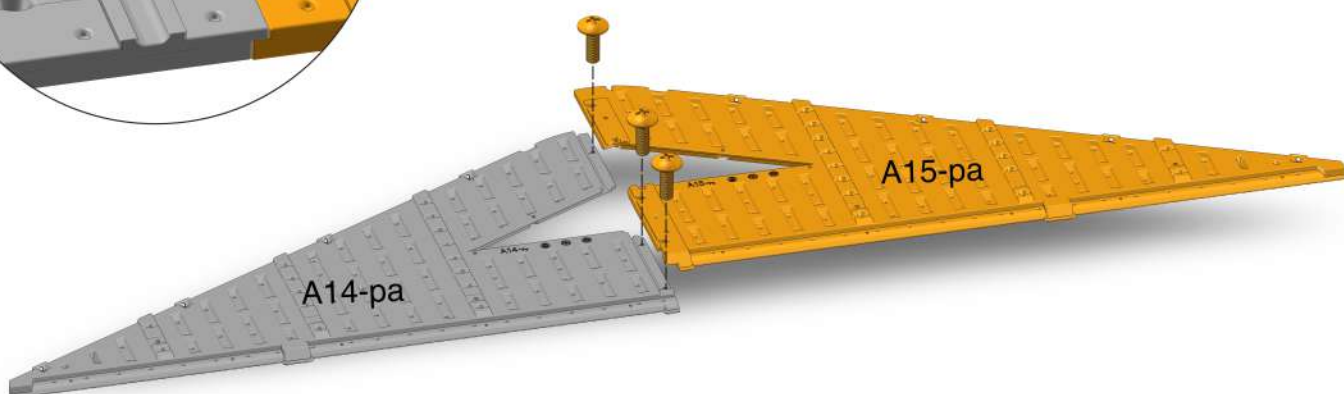
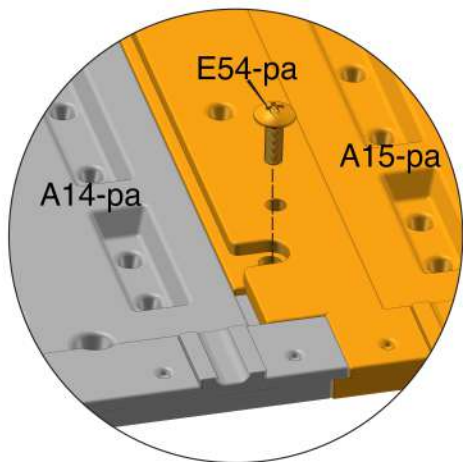

25

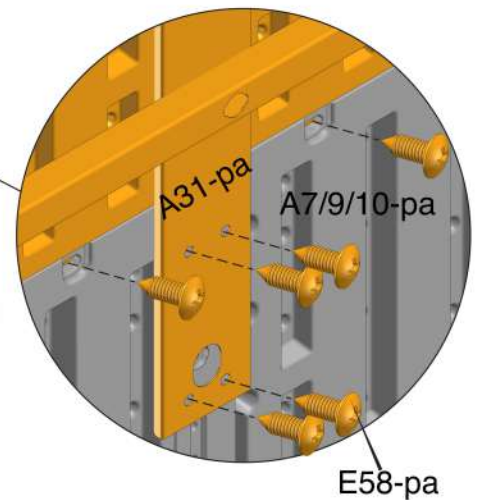
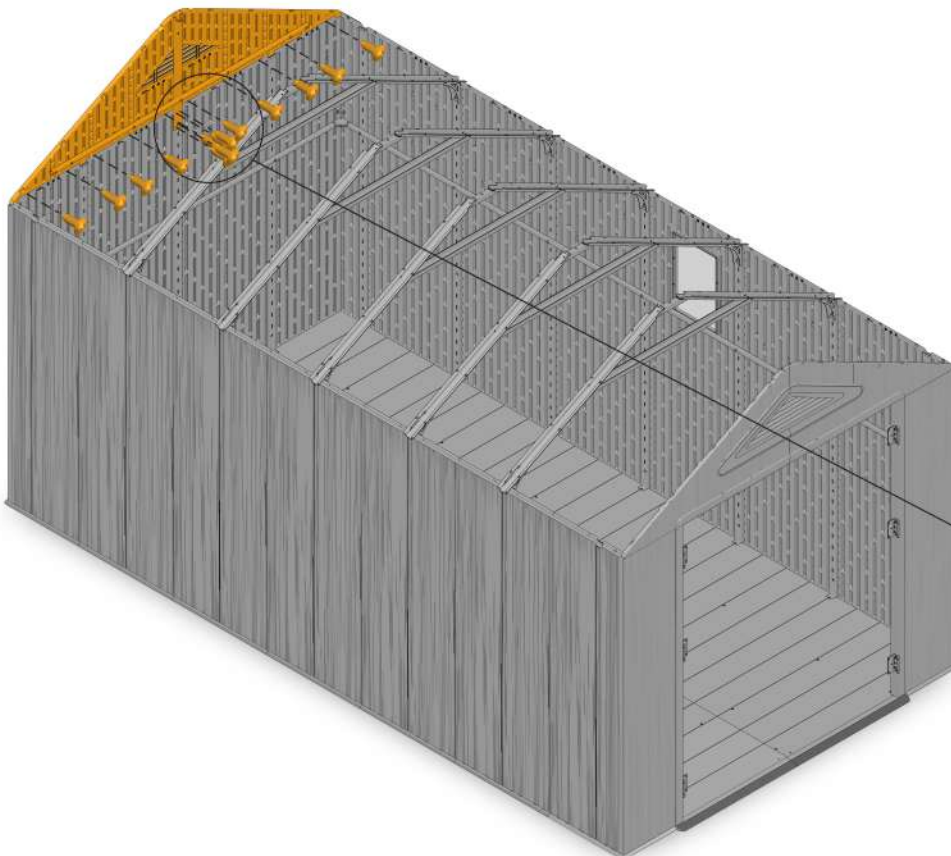
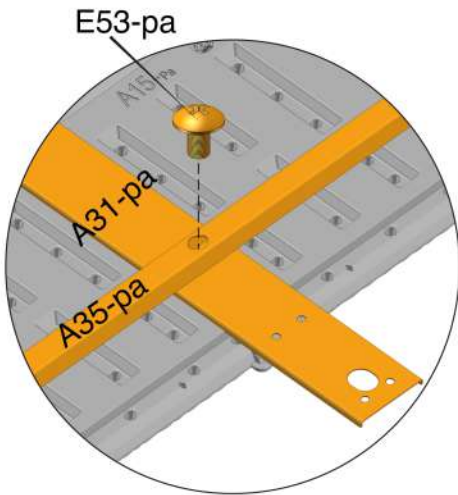
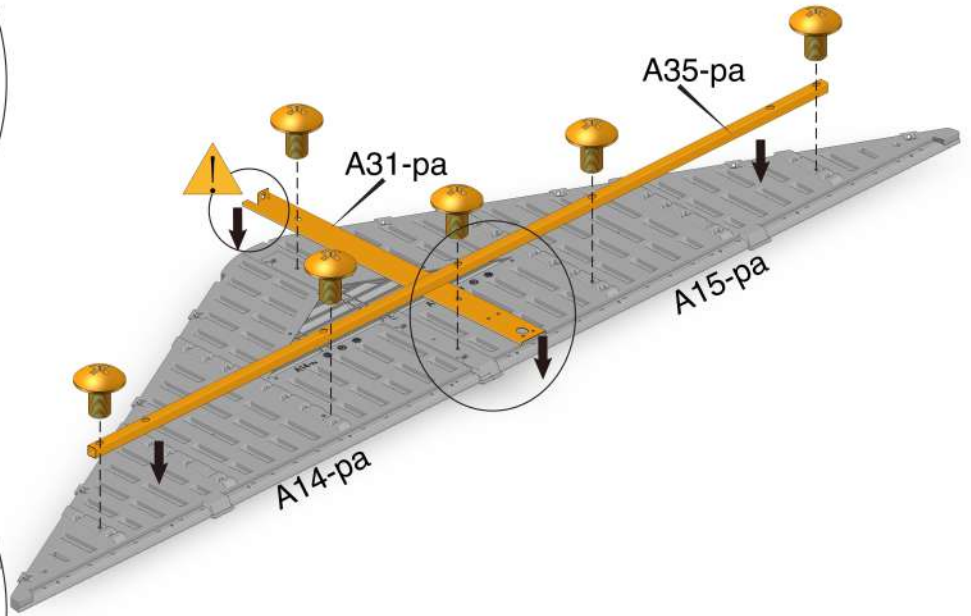
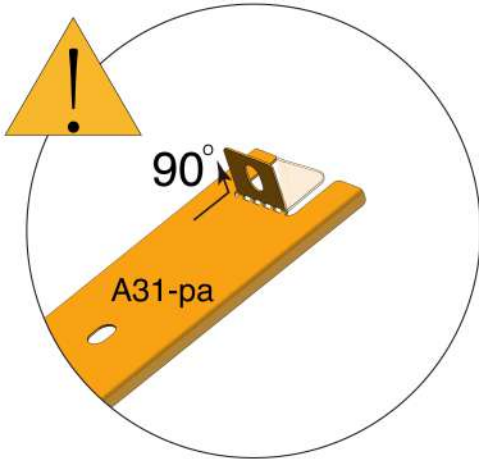

26

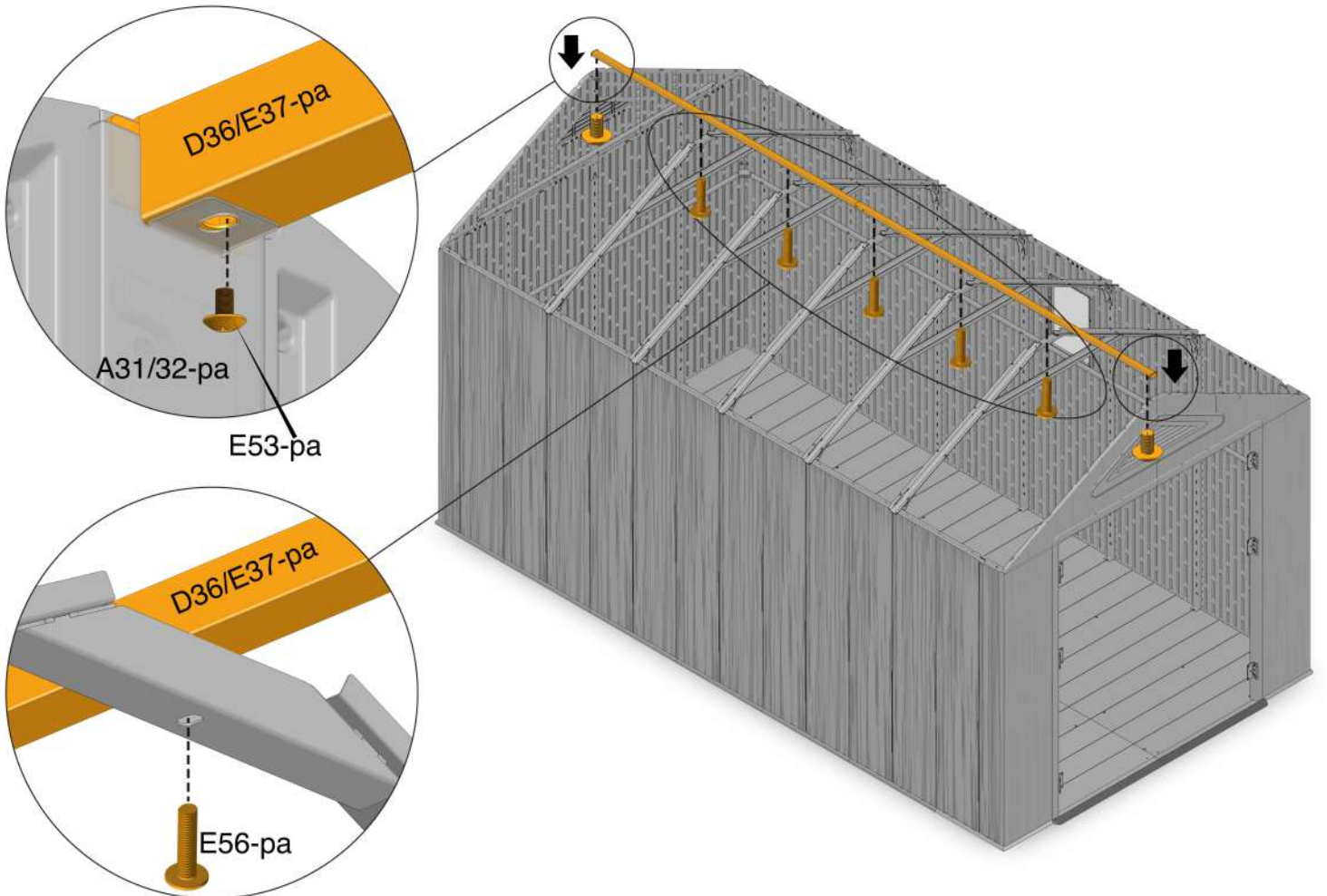
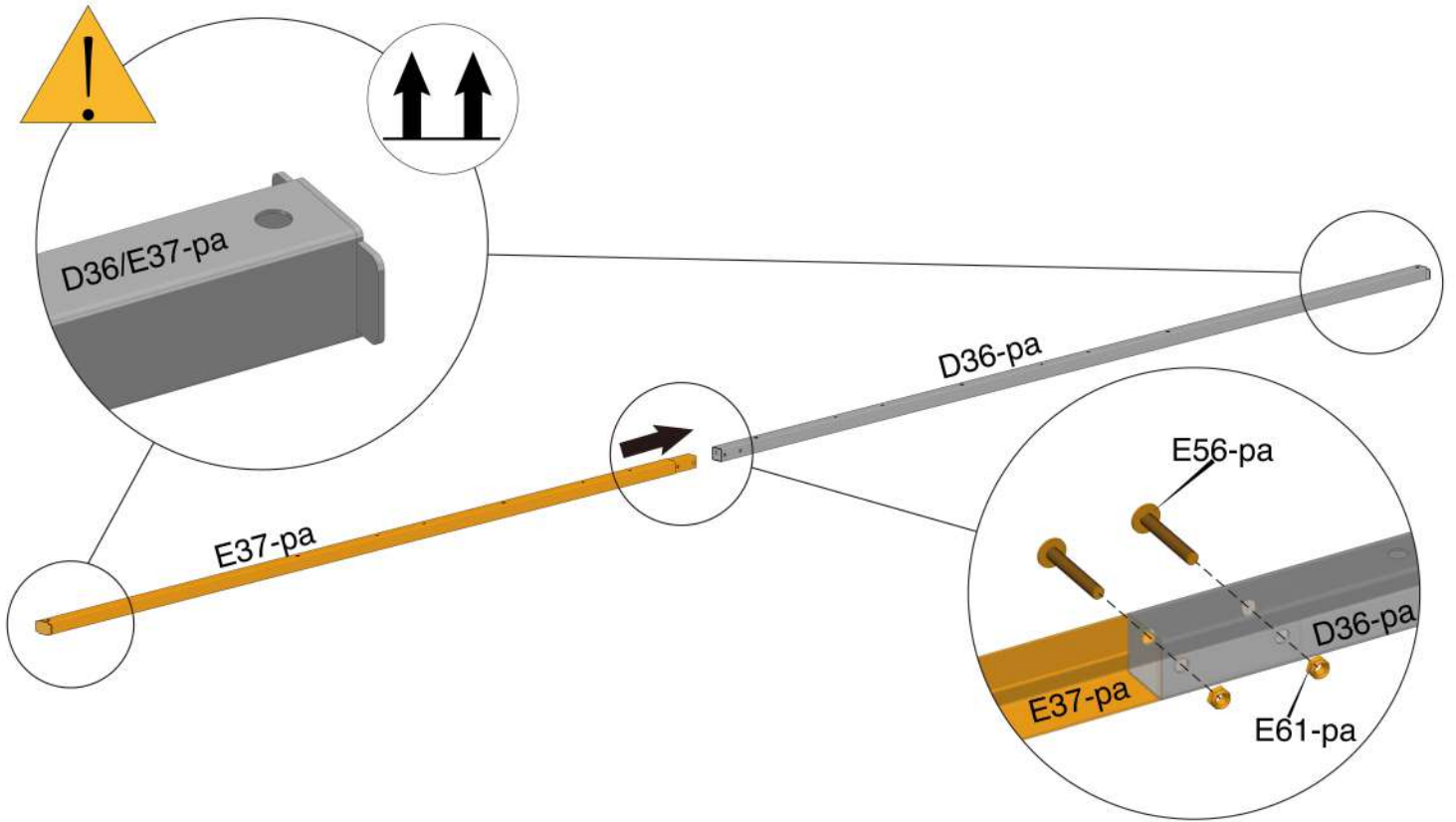
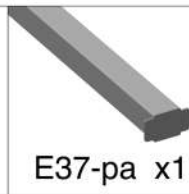
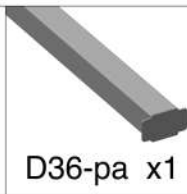

27

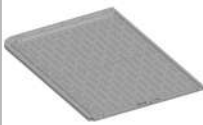

A16-pa x2

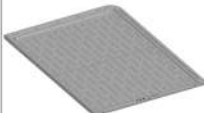

A17-pa x2

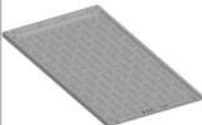

A18-pa x8



A44-pa x4



A45-pa x8



E51-pa x24

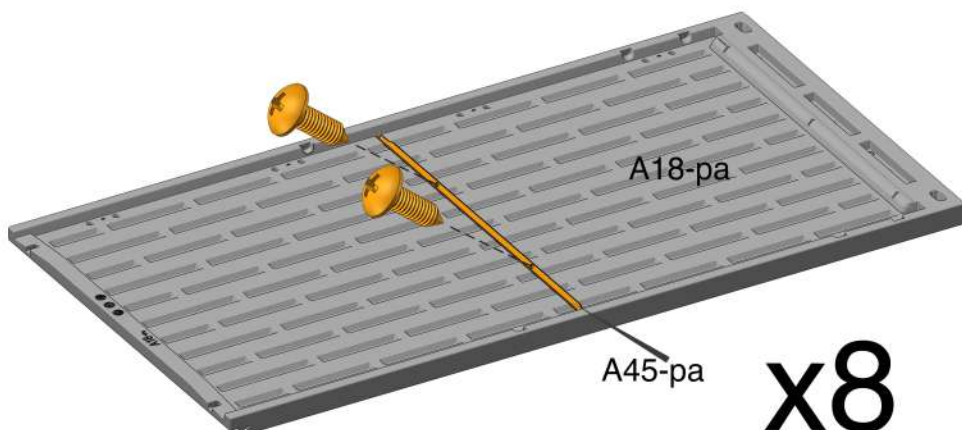
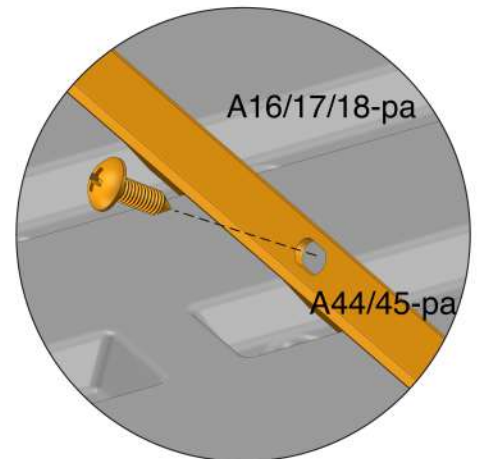
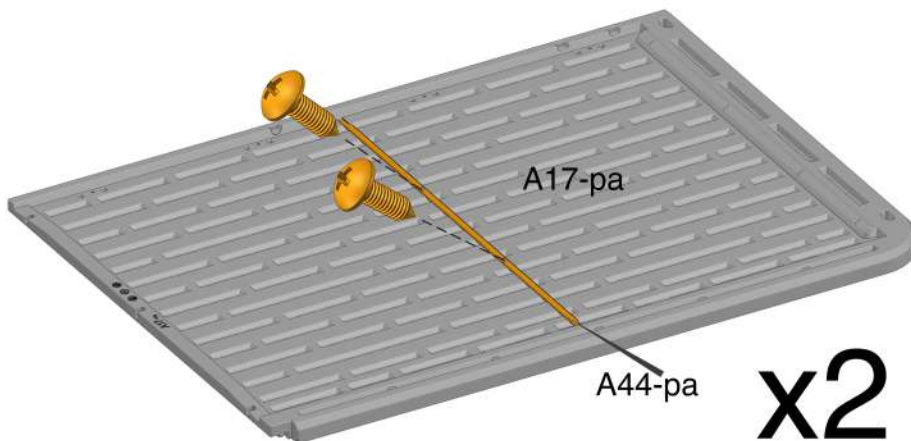
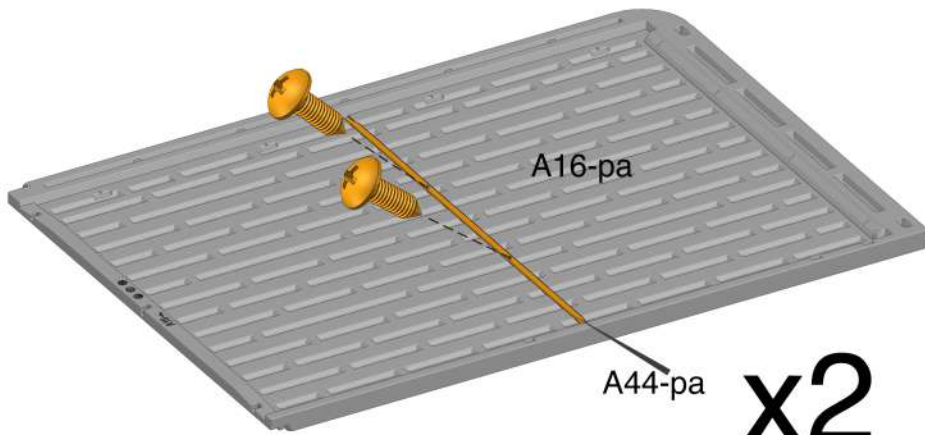
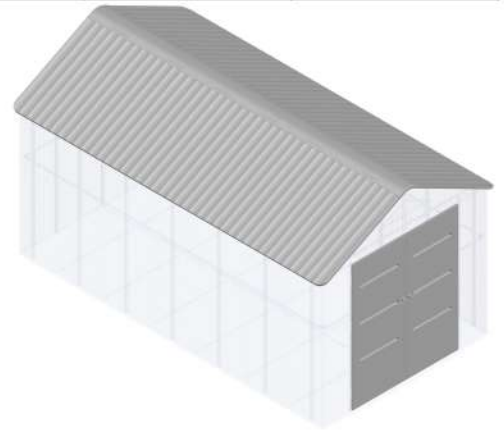

28



E59-pa x16



E58-pa x8

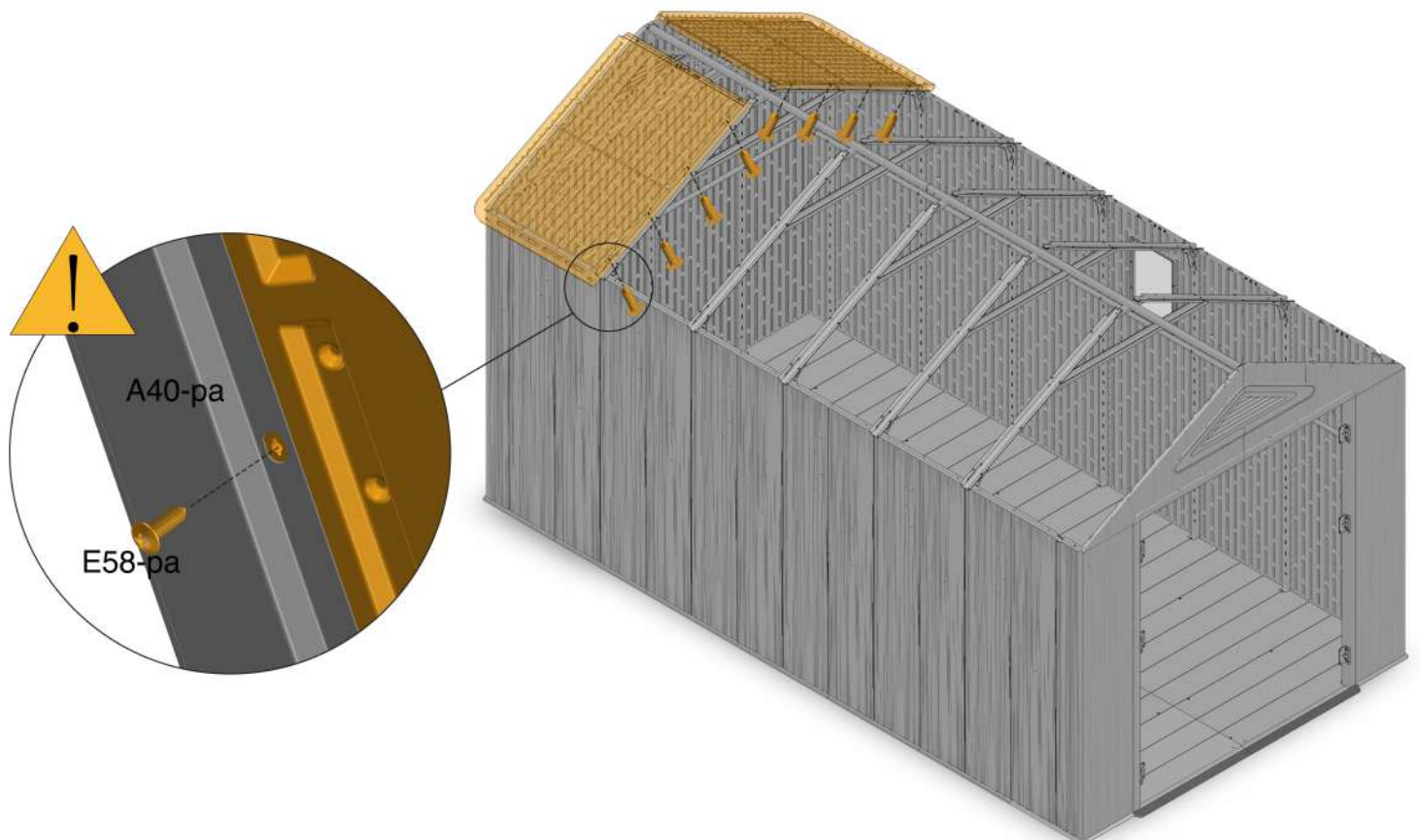
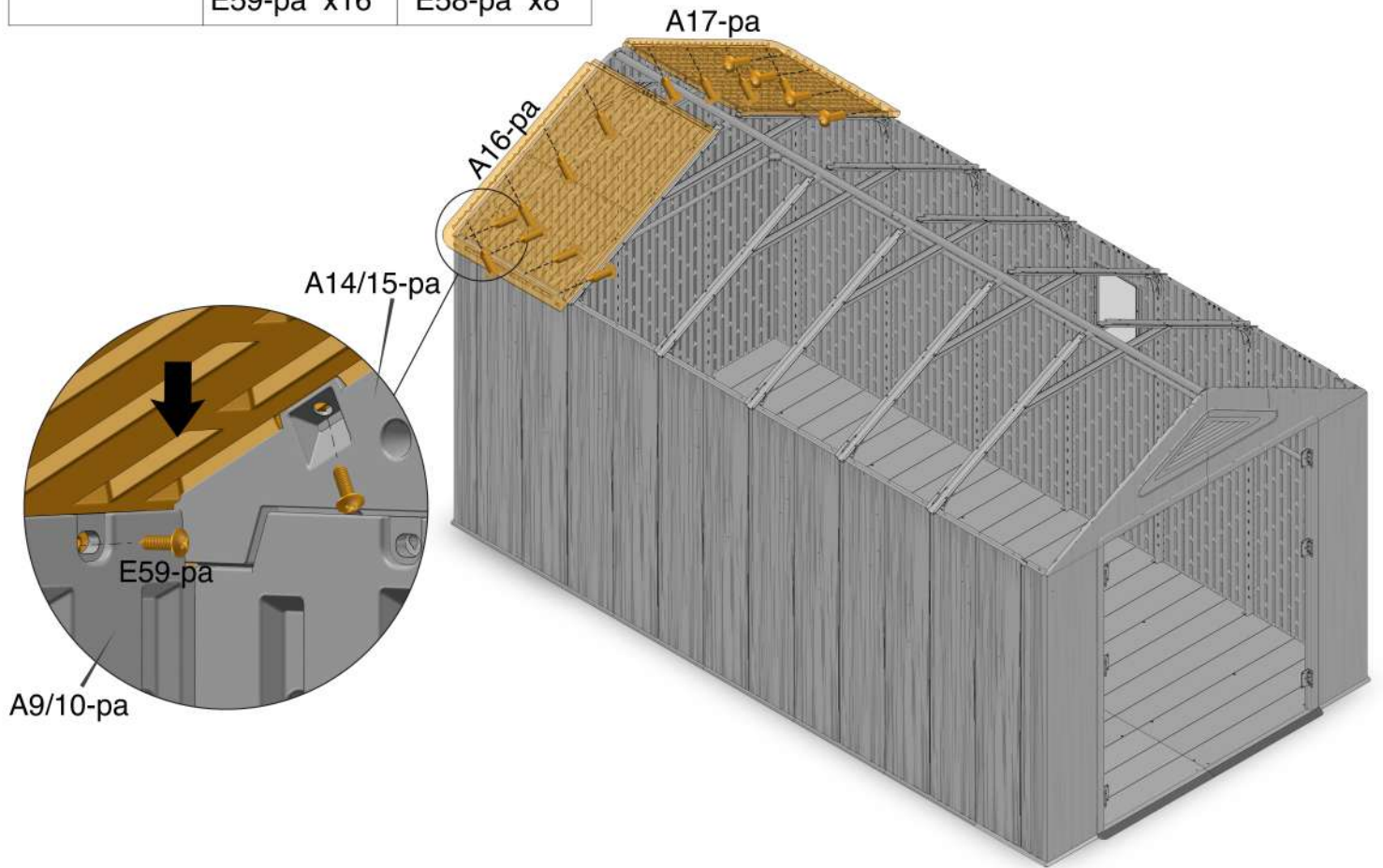

29



A19-pa x1



E59-pa x12

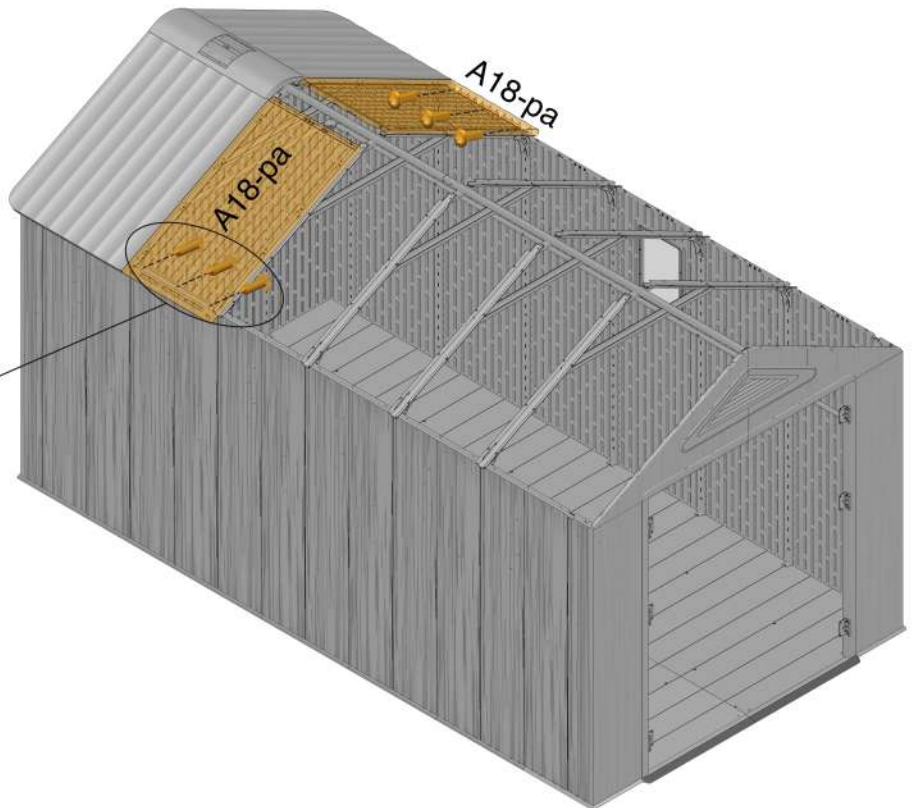
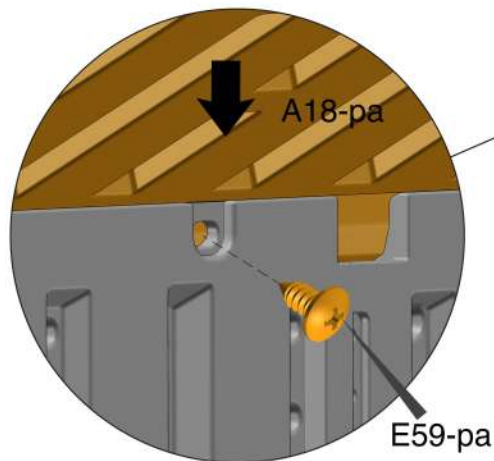
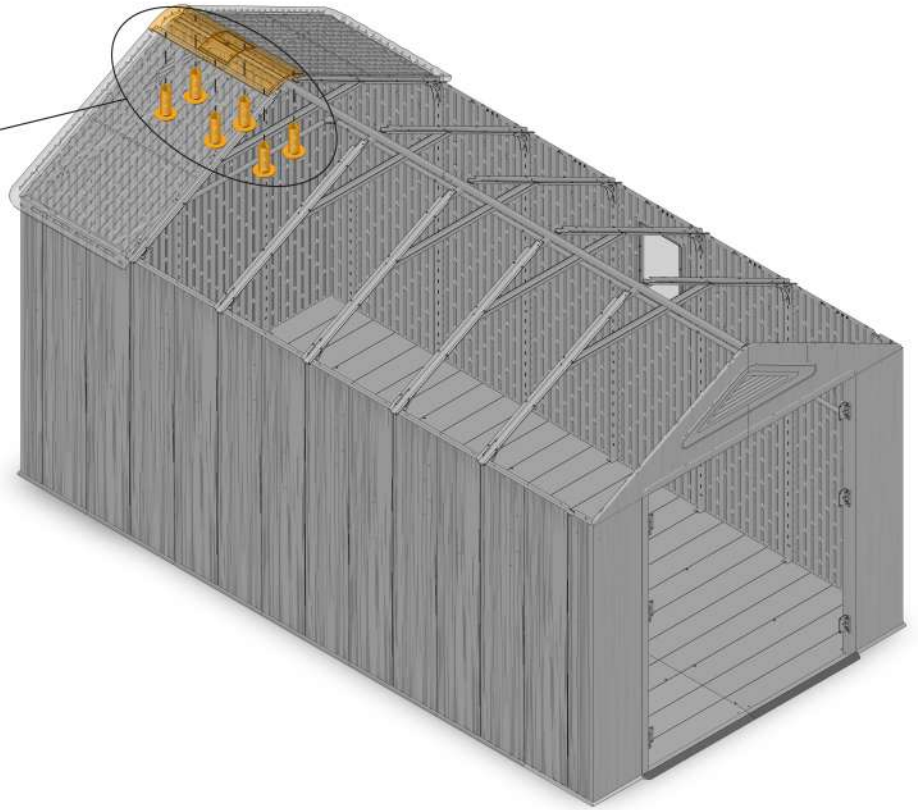
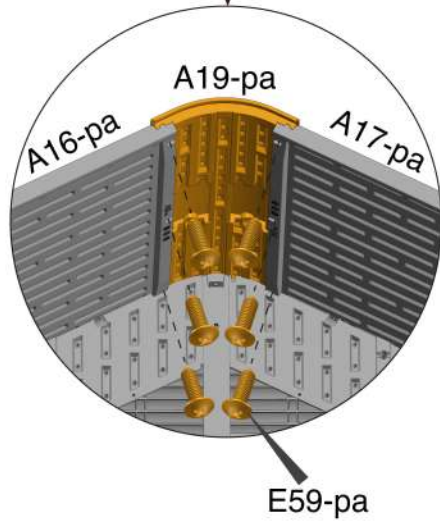
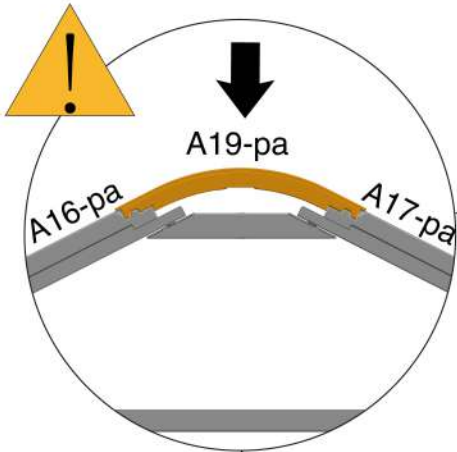

30



A21-pa x1



E58-pa x16



E59-pa x4

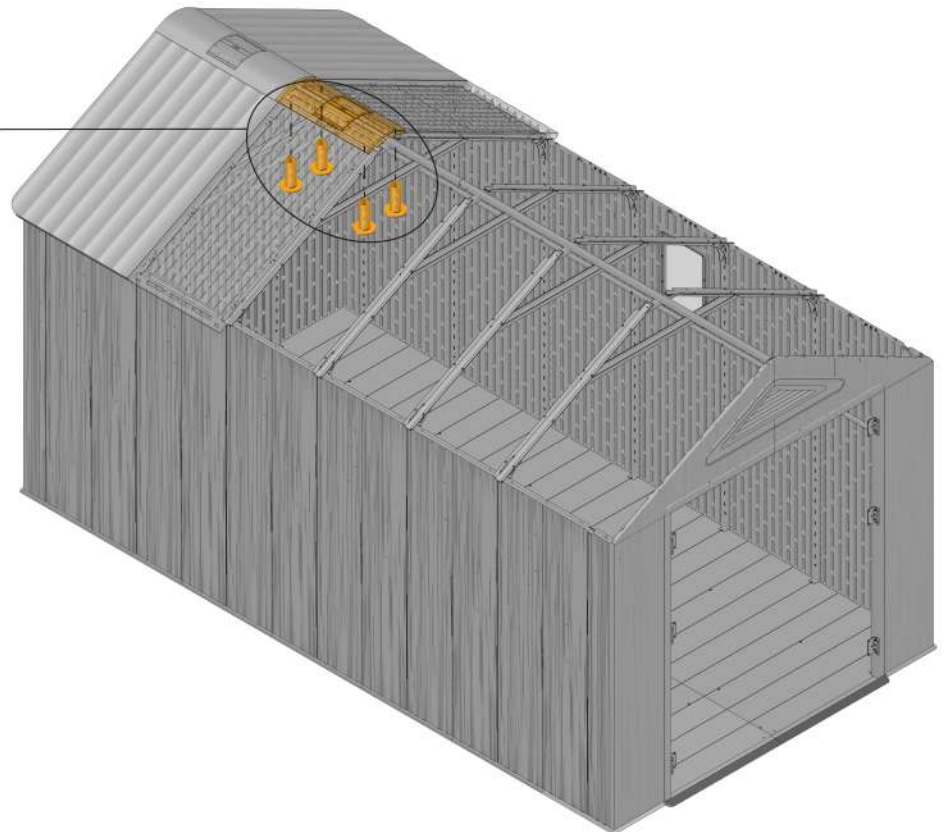
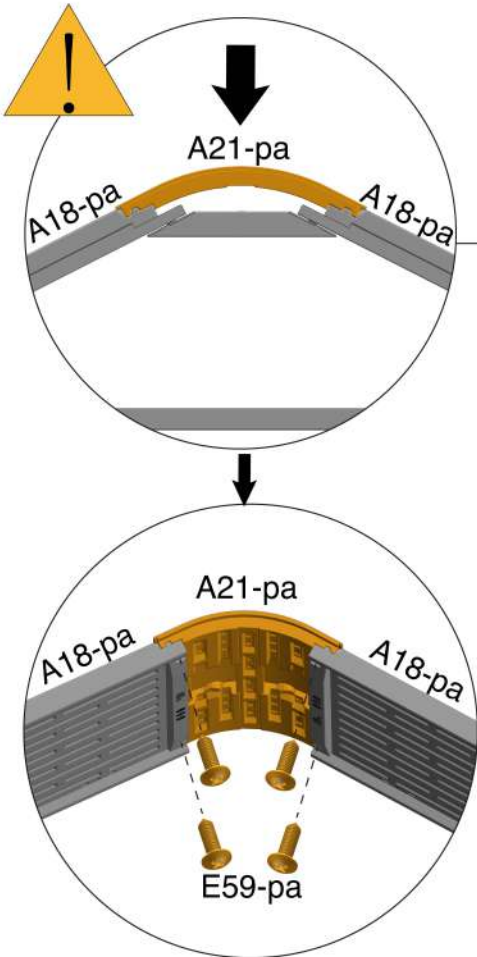
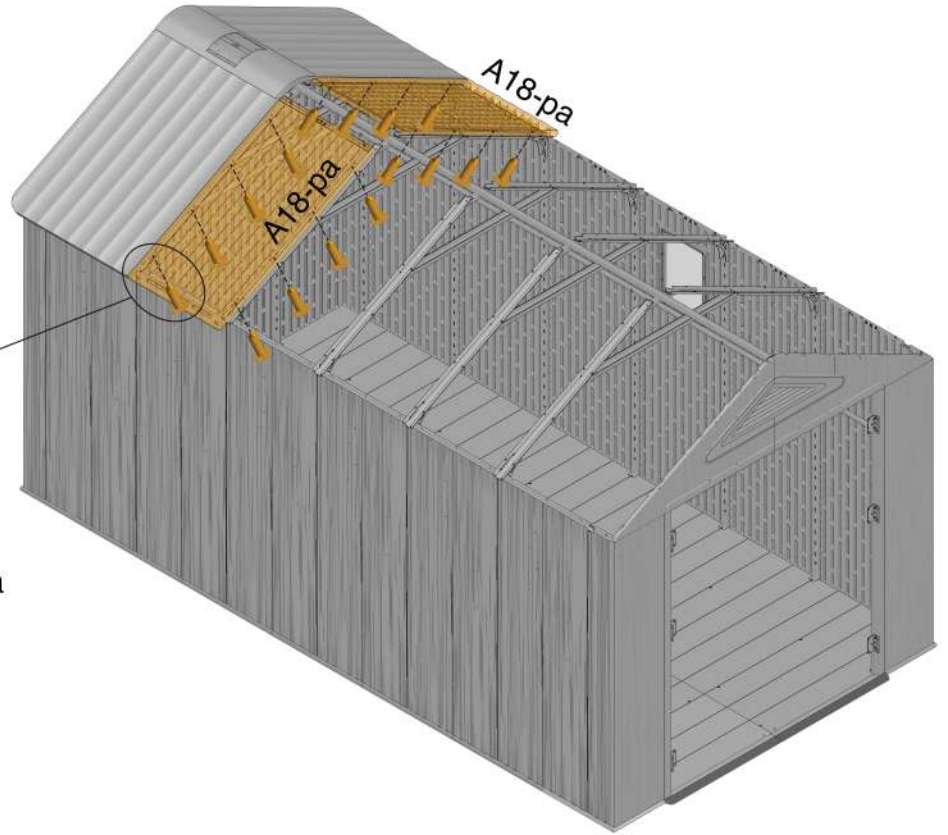
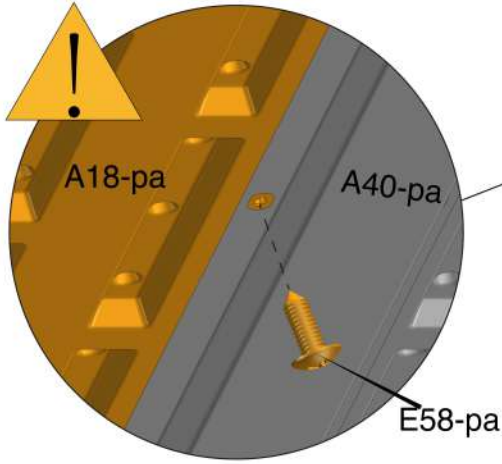

31



E59-pa x6



E58-pa x16

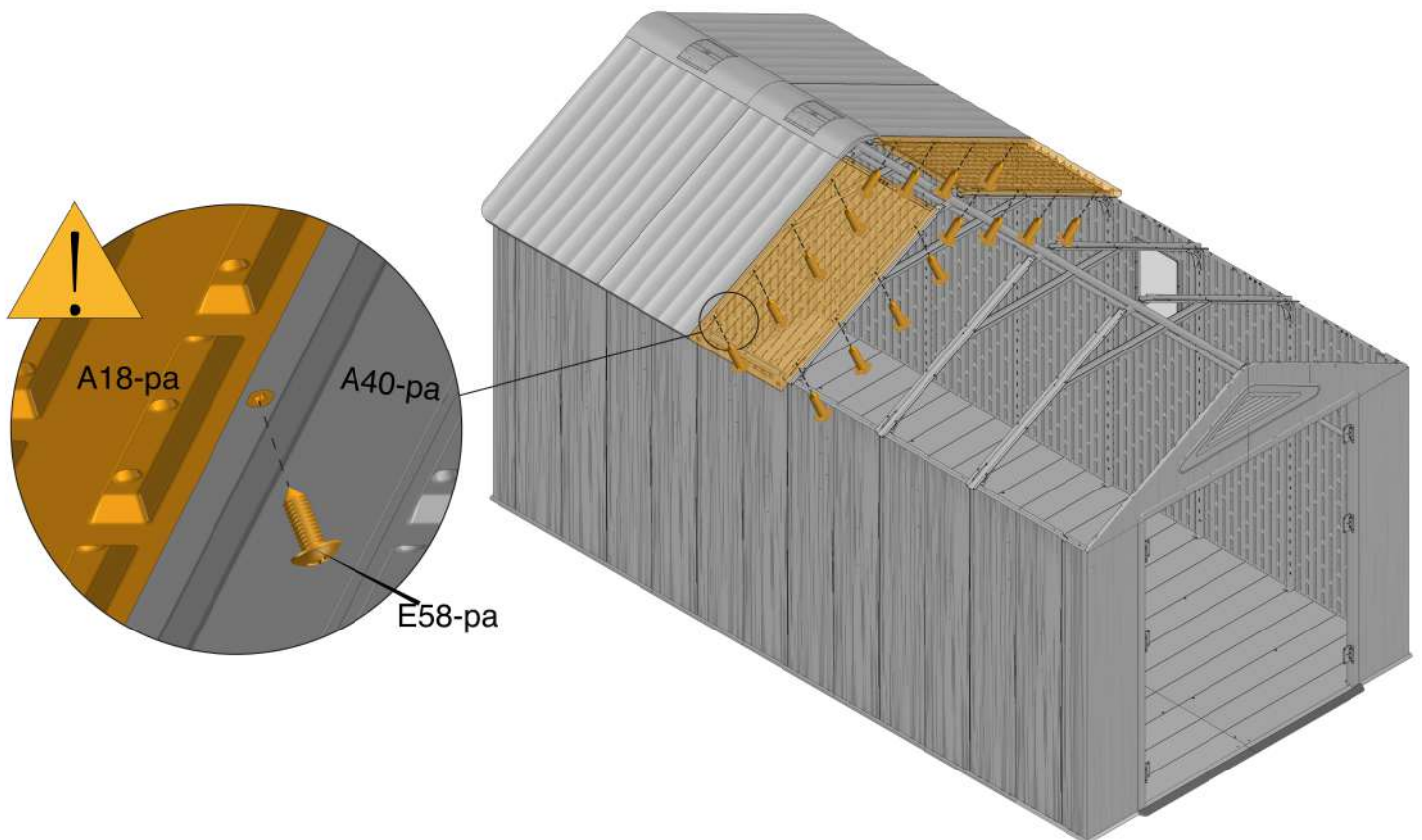
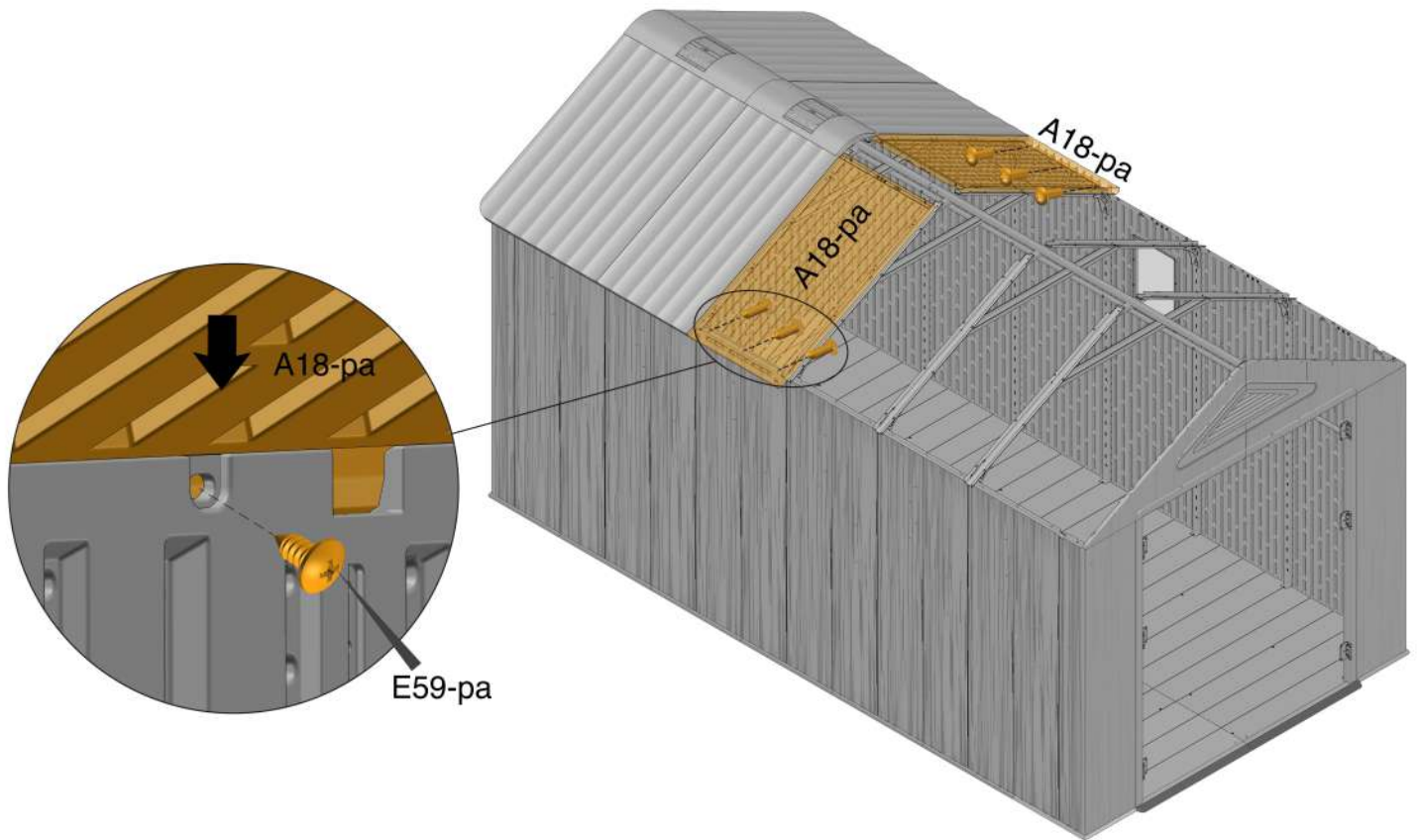

32



A21-pa x1



E59-pa x10

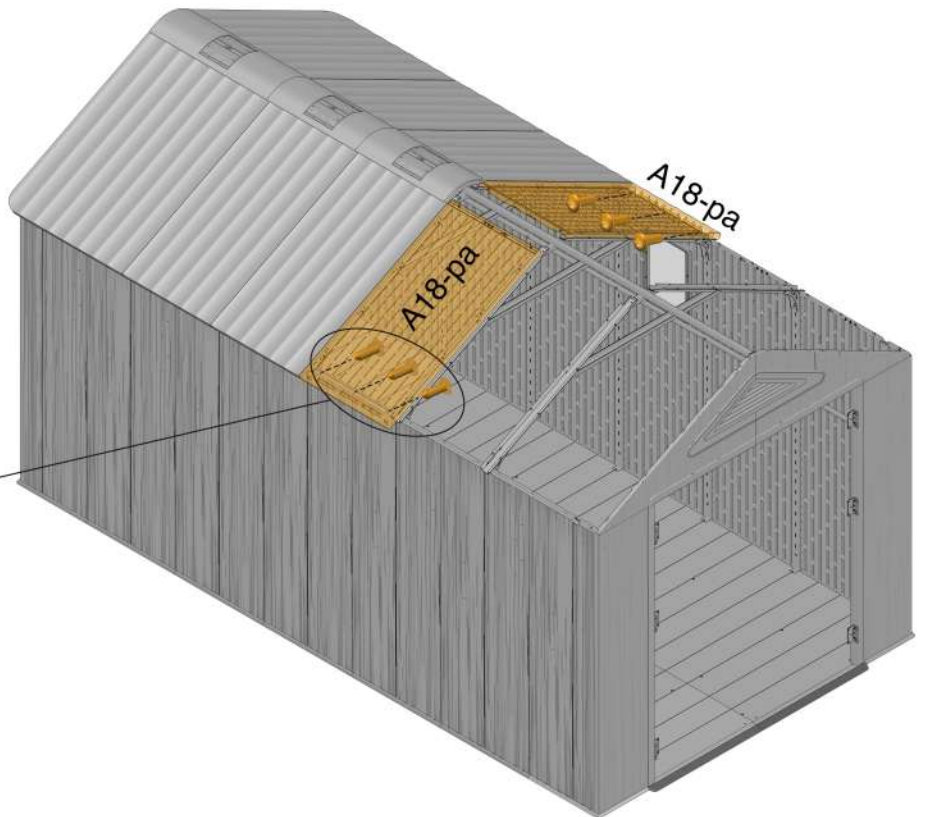
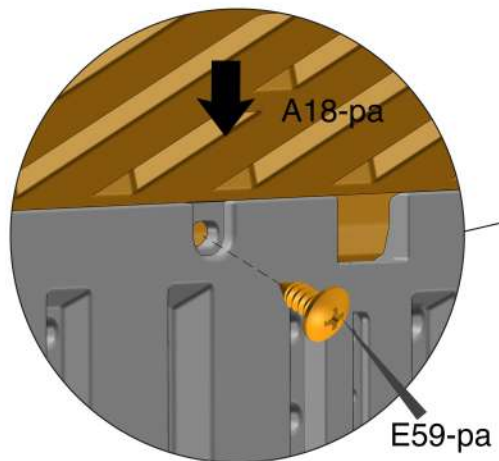
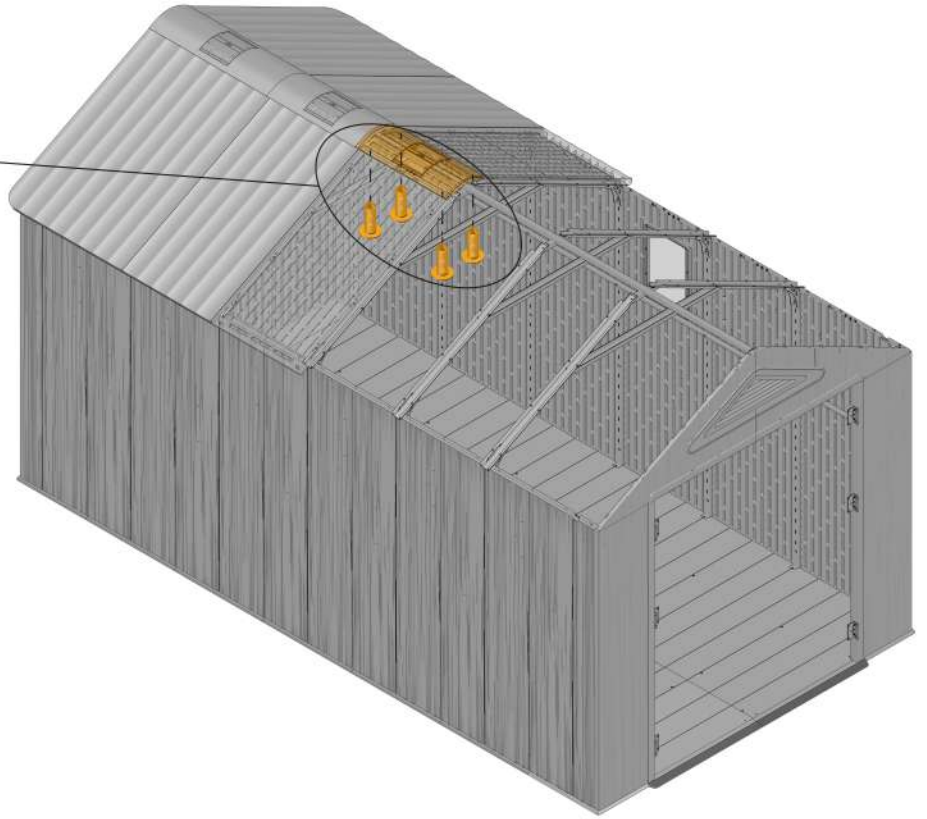
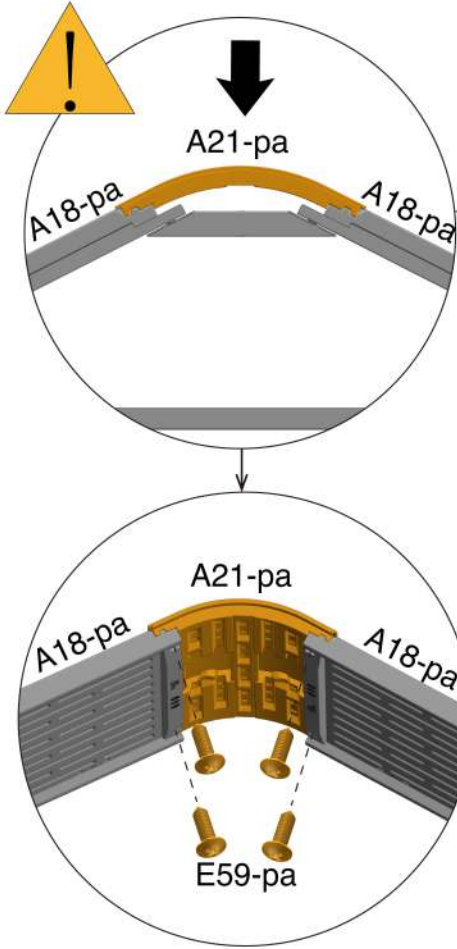

33



A21-pa x1



E58-pa x16



E59-pa x4

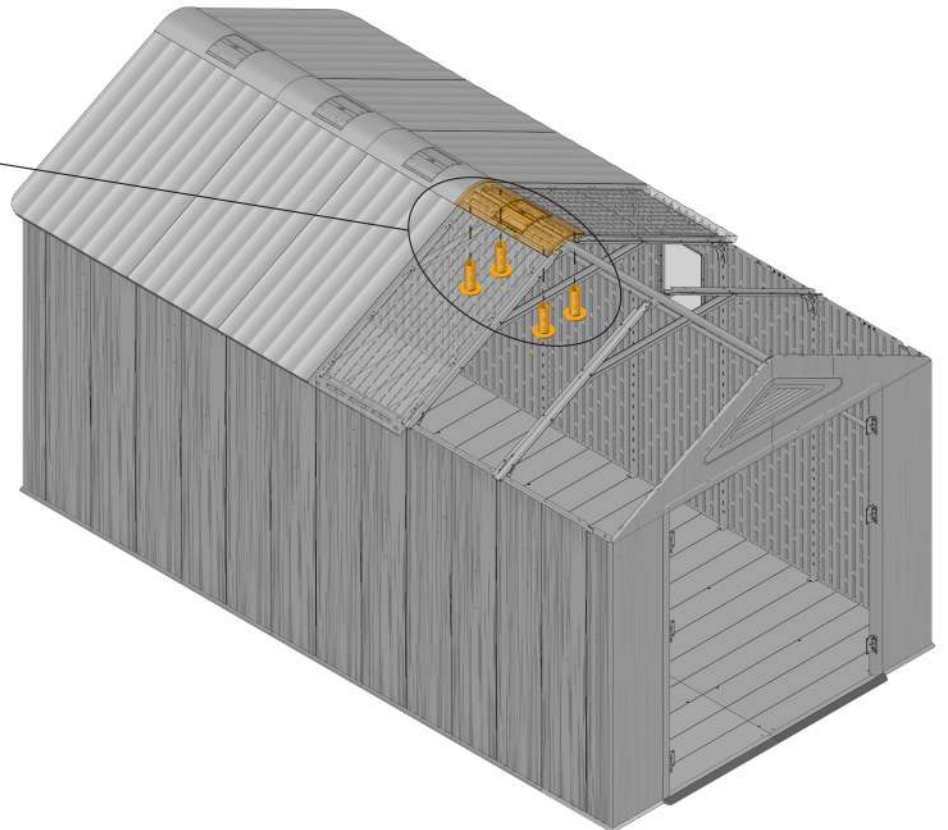
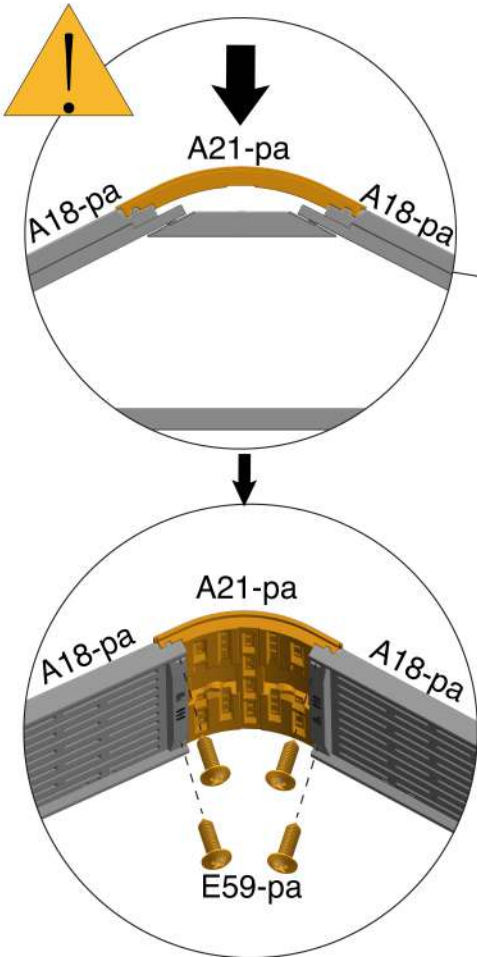
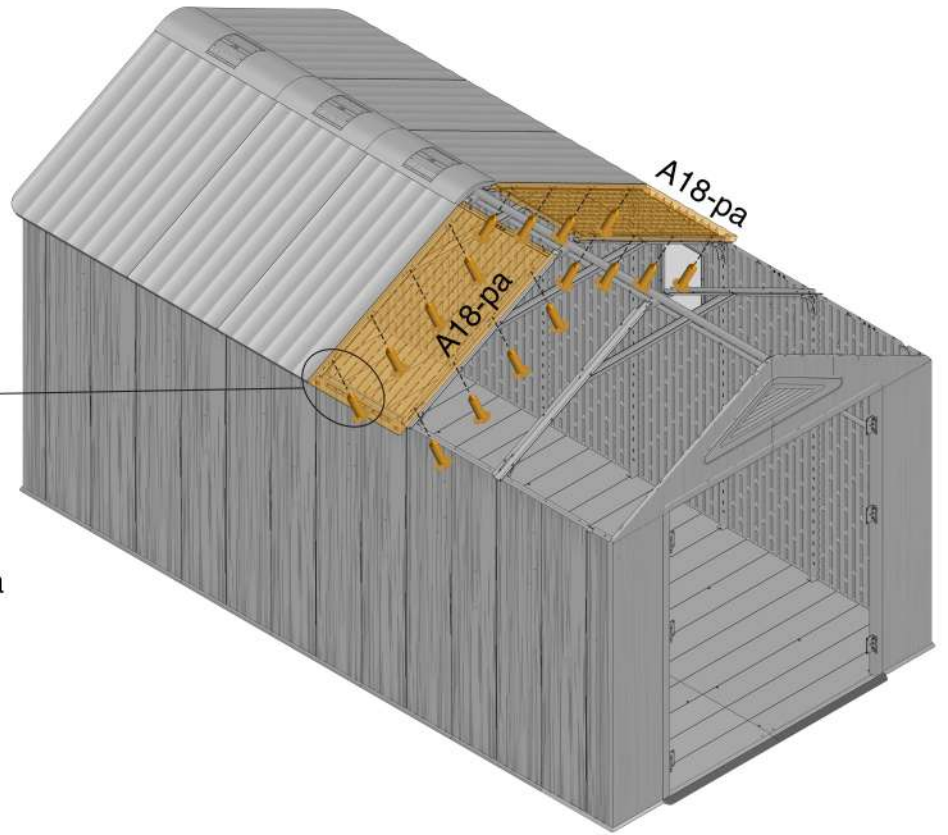
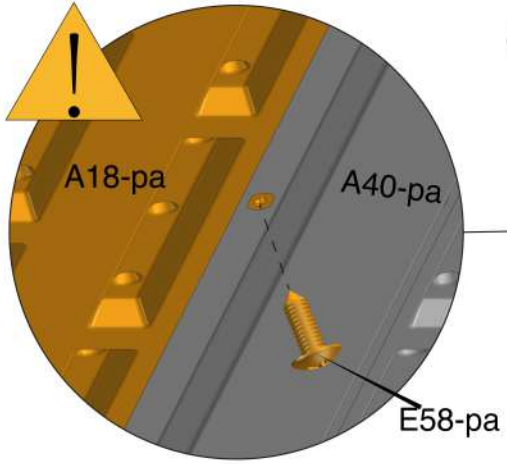

34



E59-pa x6



E58-pa x16

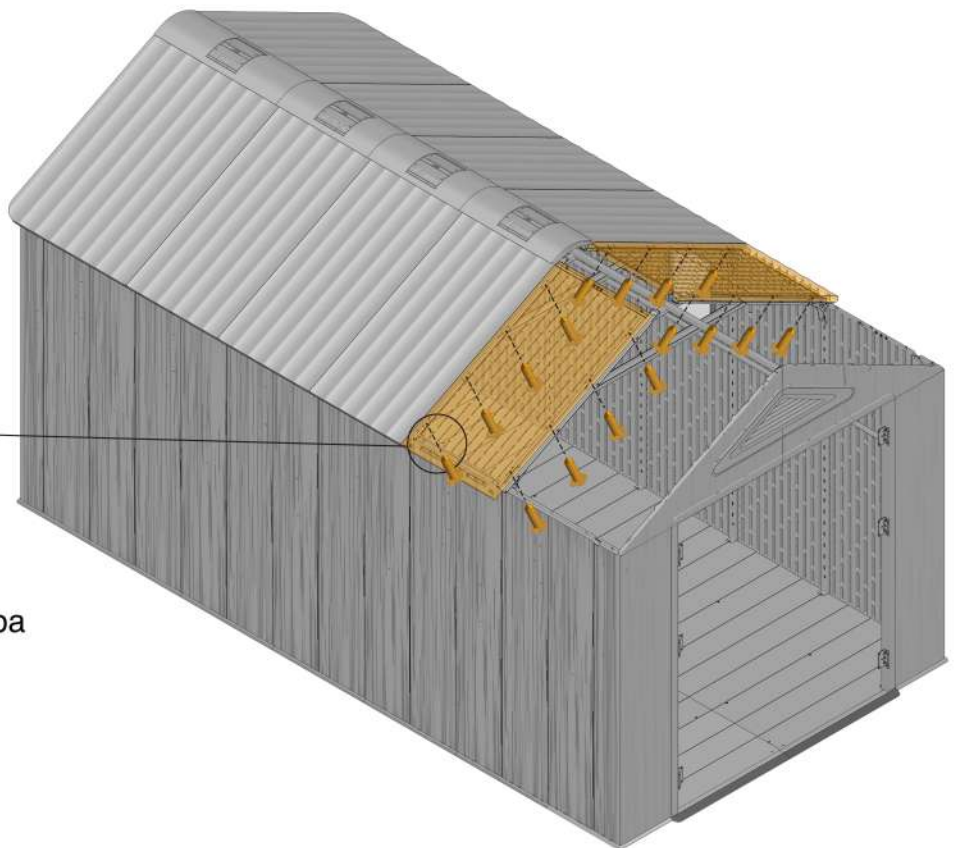
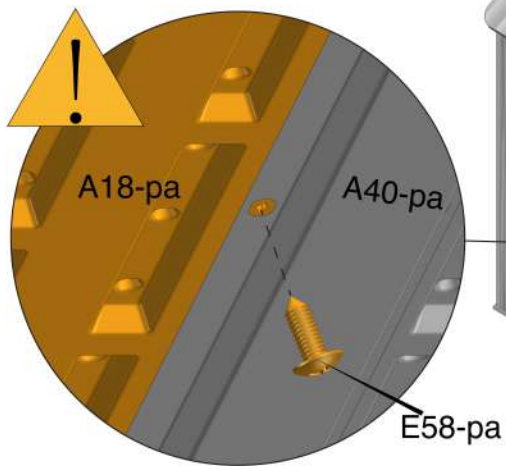
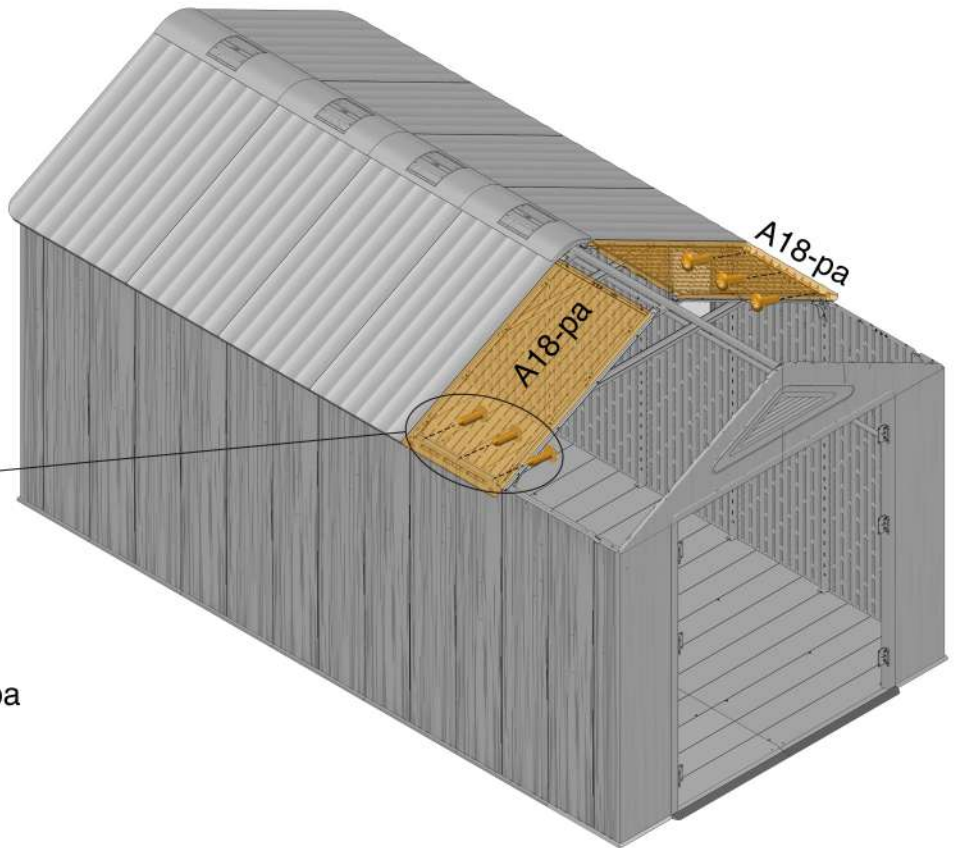
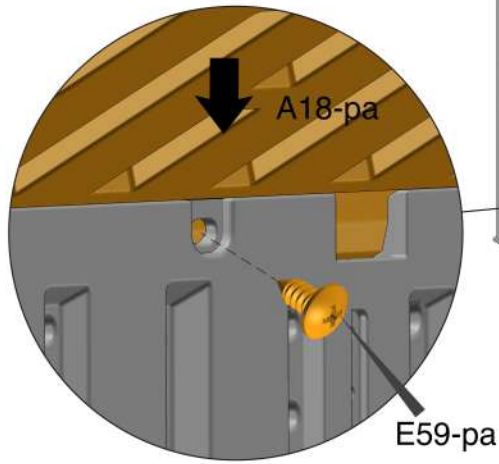

35



A21-pa x1



E59-pa x20

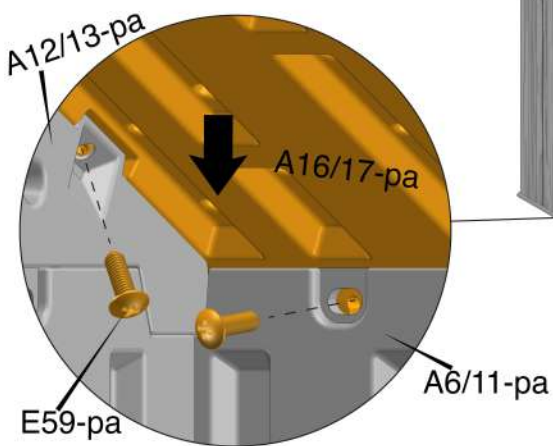
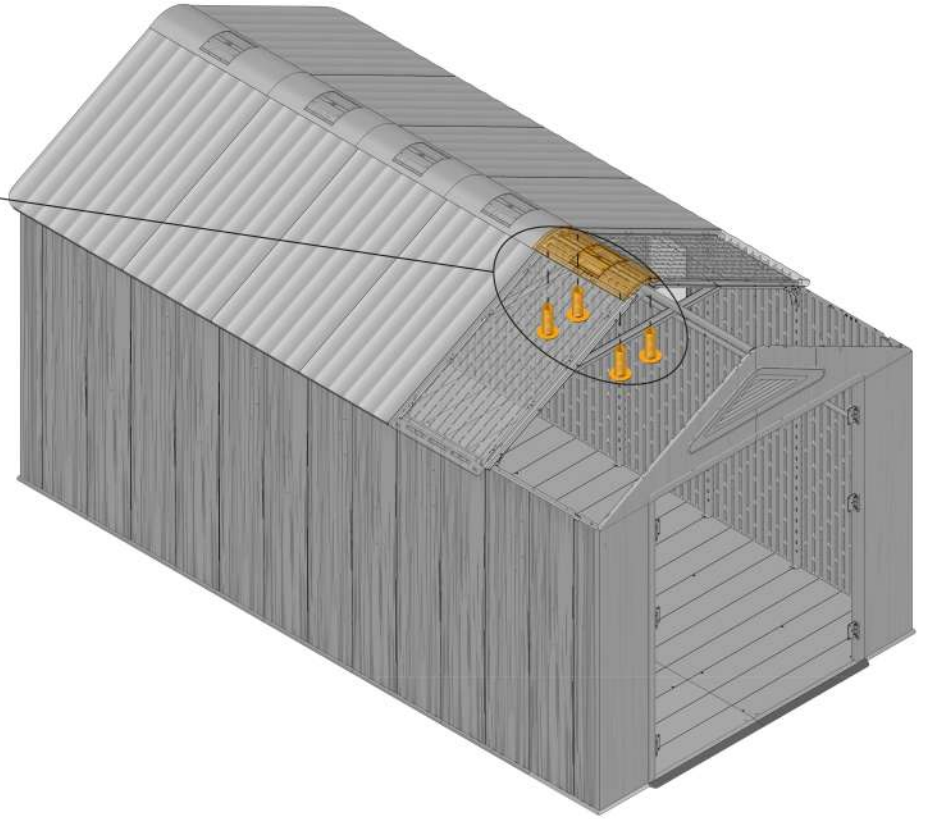
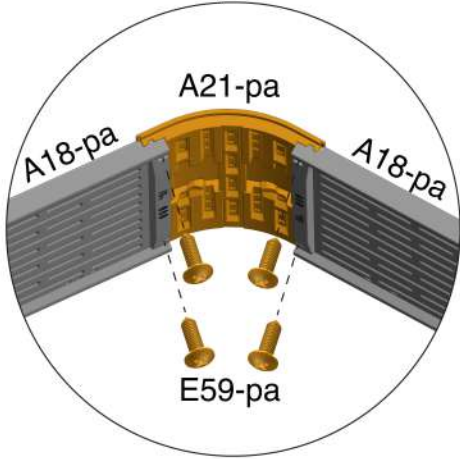
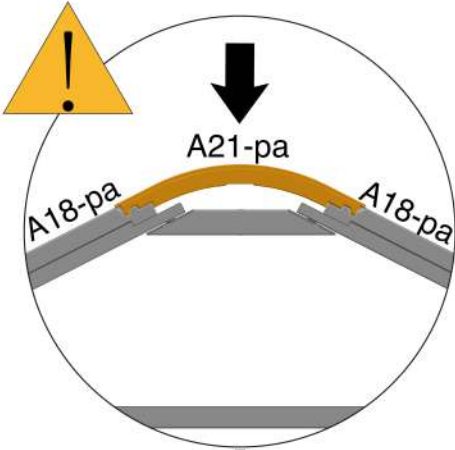

36



A20-pa x1



E58-pa x8



E59-pa x6

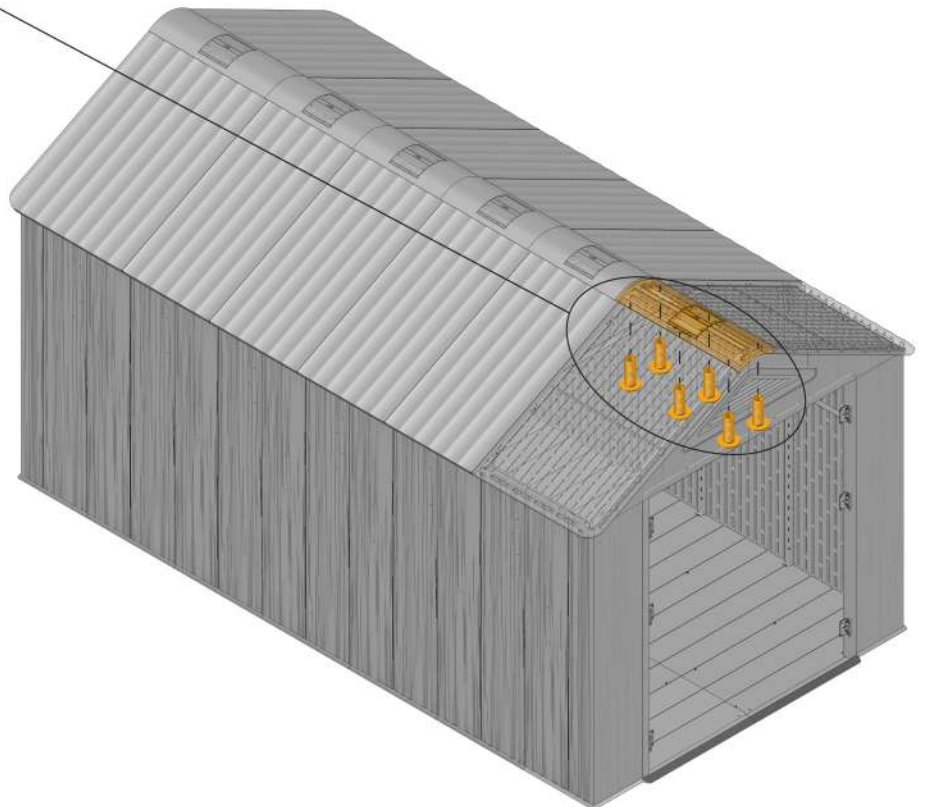
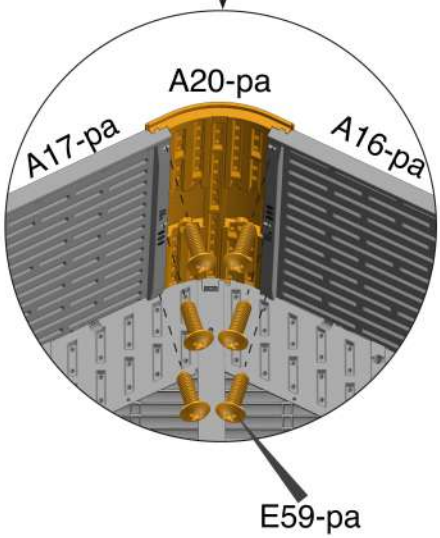
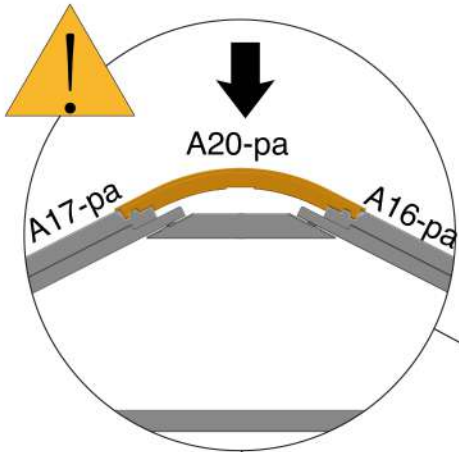
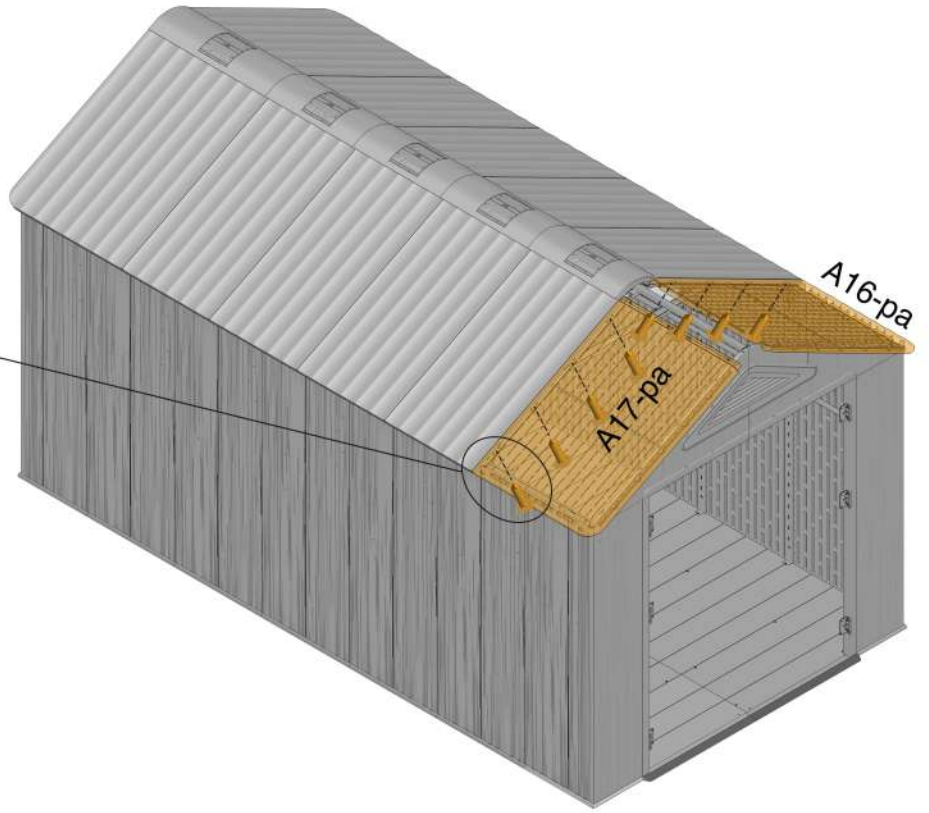
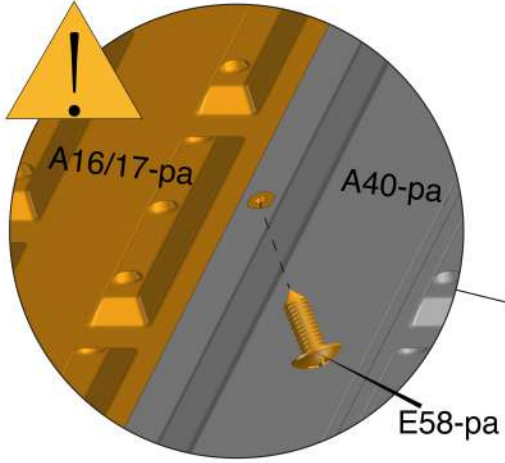

37

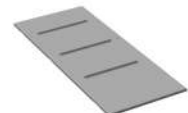

A22-pa x1



A23-pa x1



A34-pa x2



A34a-pa x2



E57-pa x20

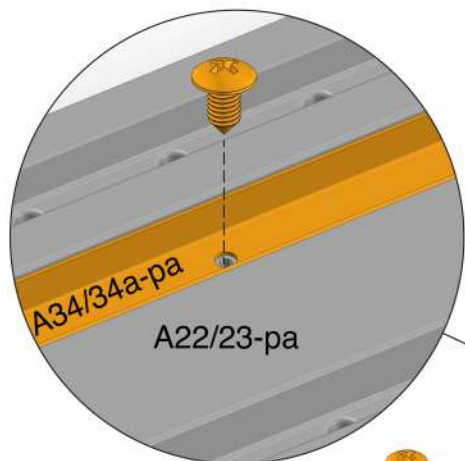

A22/23-pa

A34/34a-pa

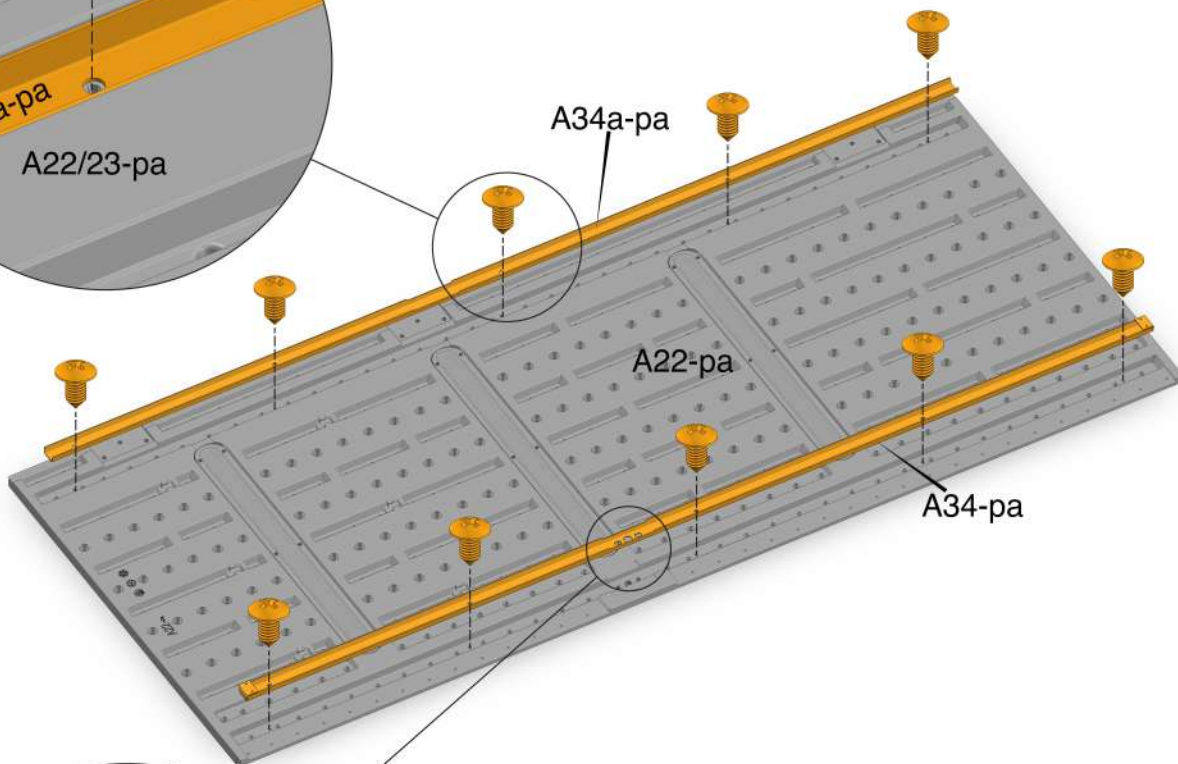

A34a-pa

A22-pa

A34-pa

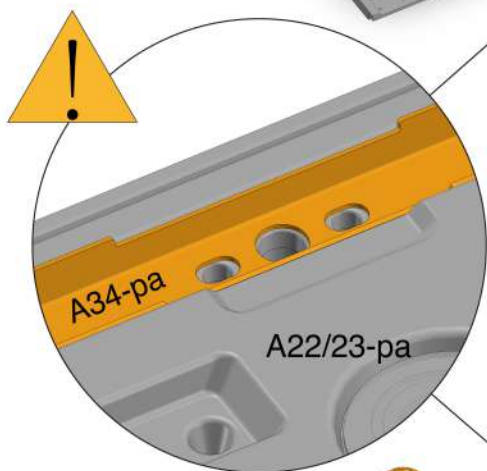

A34-pa

A22/23-pa

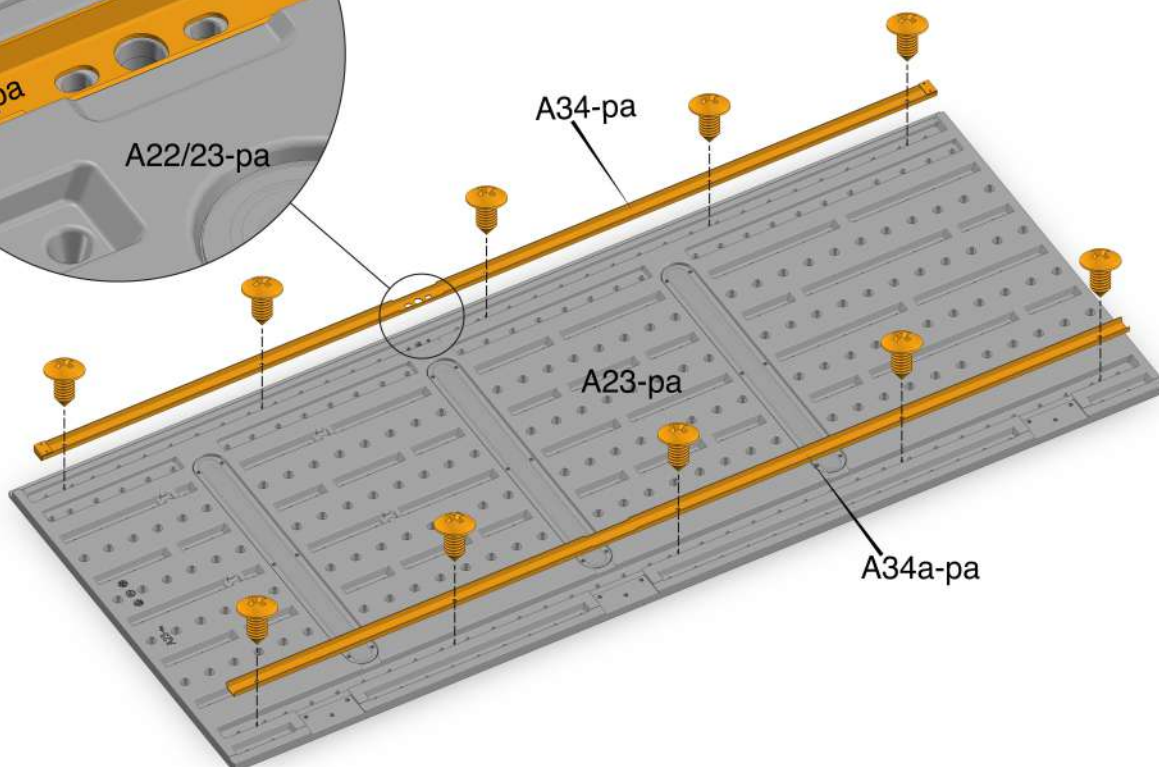

A34-pa

A23-pa

A34a-pa

38



13-pa x2



14-pa x2



E51-pa x8

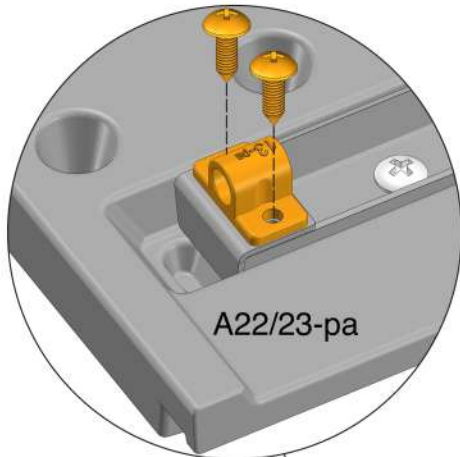

A22/23-pa

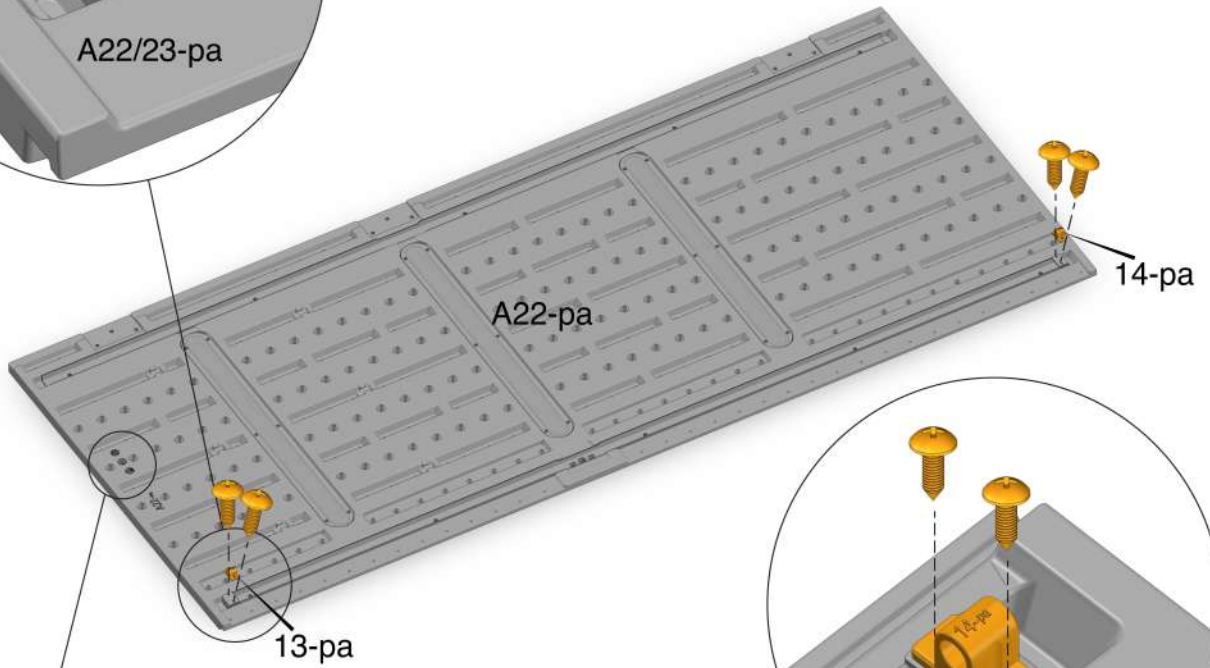

A22-pa

14-pa

13-pa

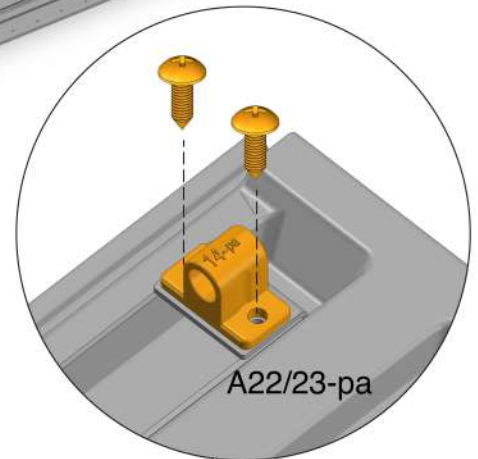

A22/23-pa



14-pa

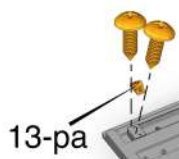

13-pa

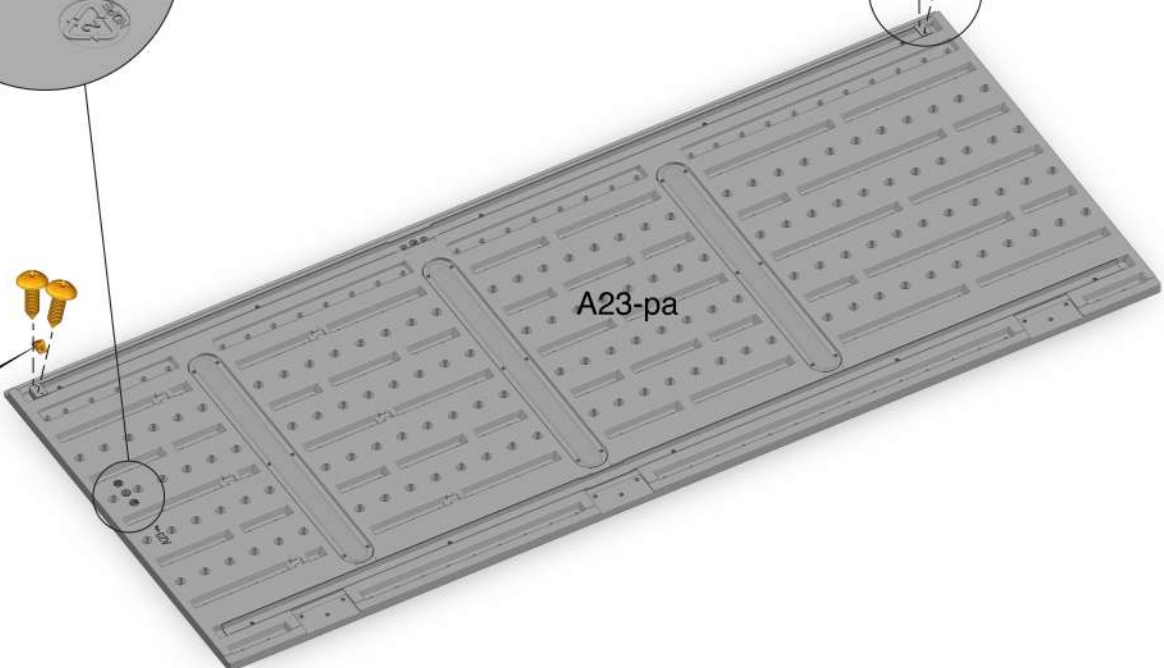

A23-pa

39



E53-pa x9

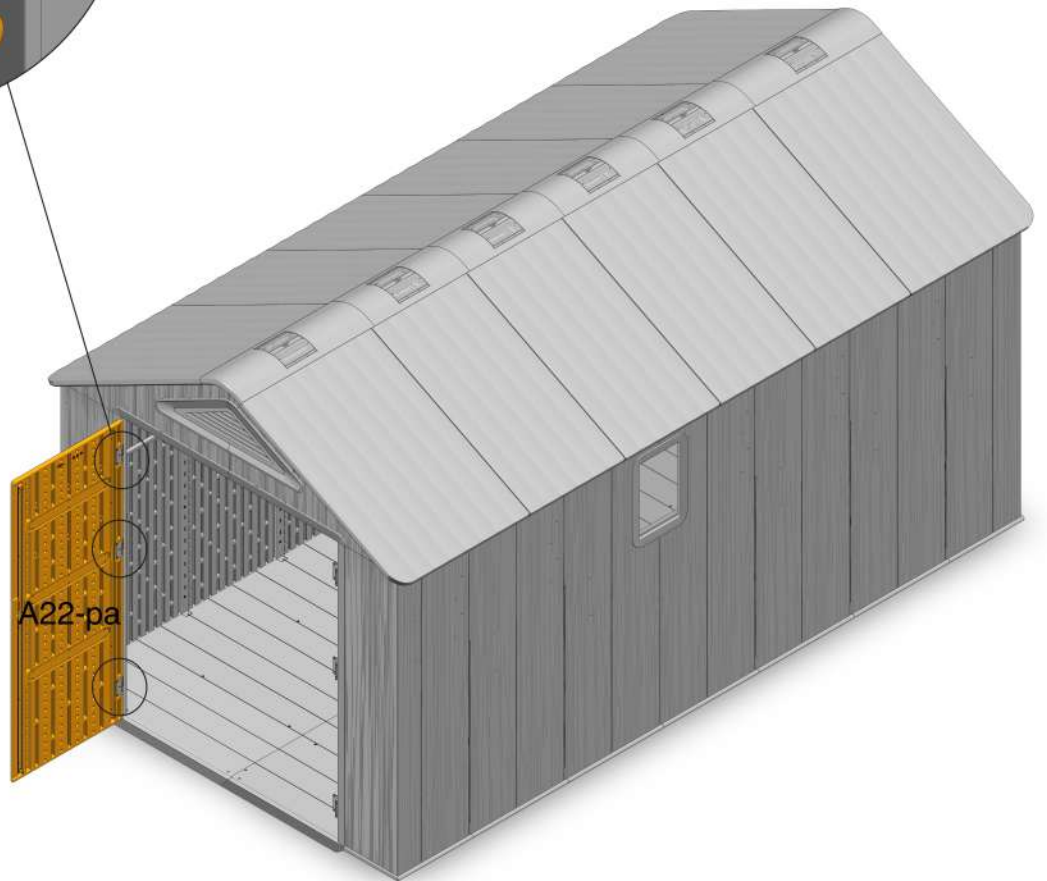
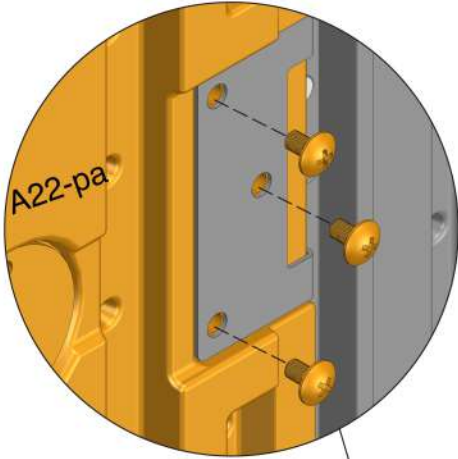

40



1-pa x1



1.1-pa x2



1.2-pa x2

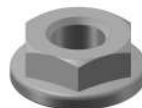

1.3-pa x1



1.4-pa x1



1.5-pa x1



7-pa x1

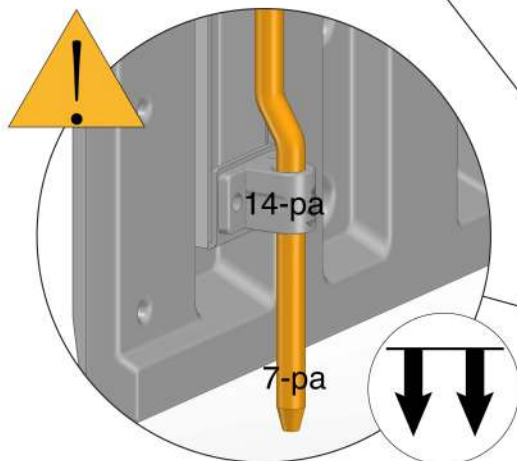
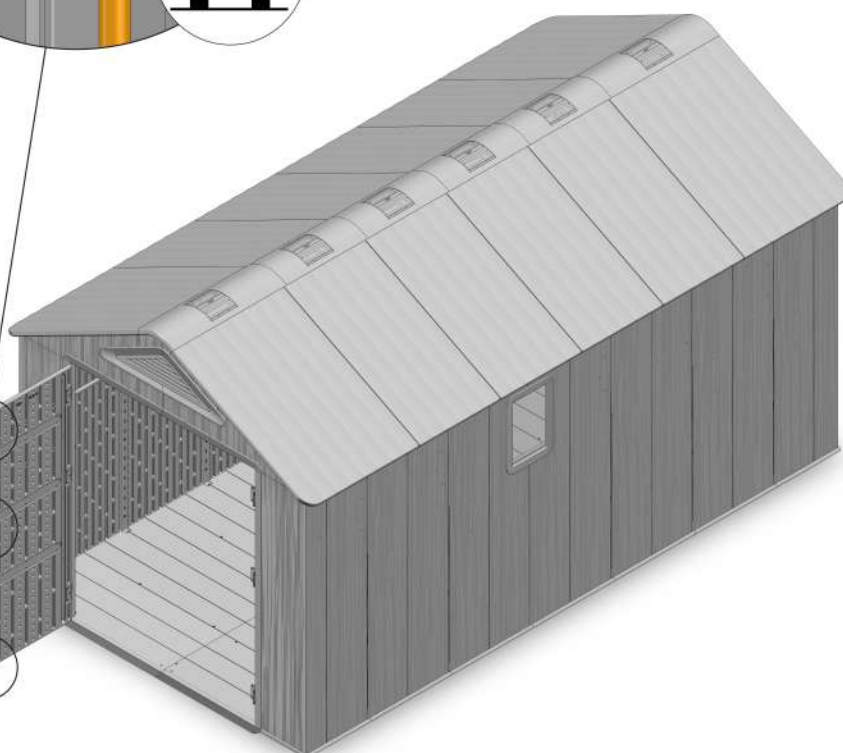
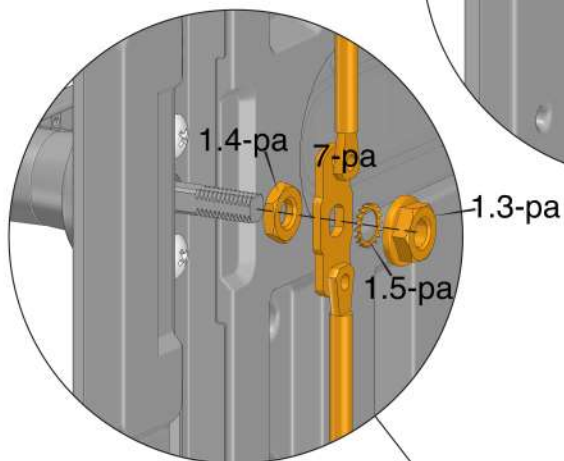
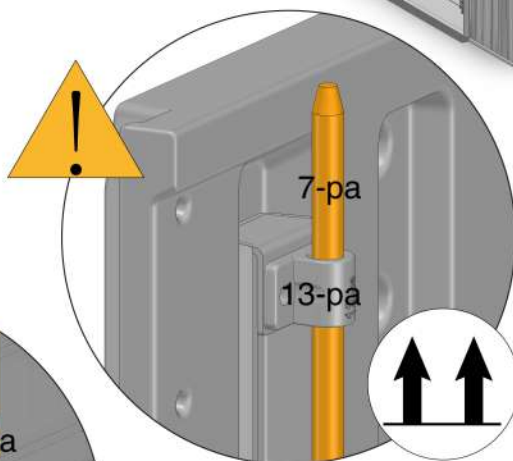
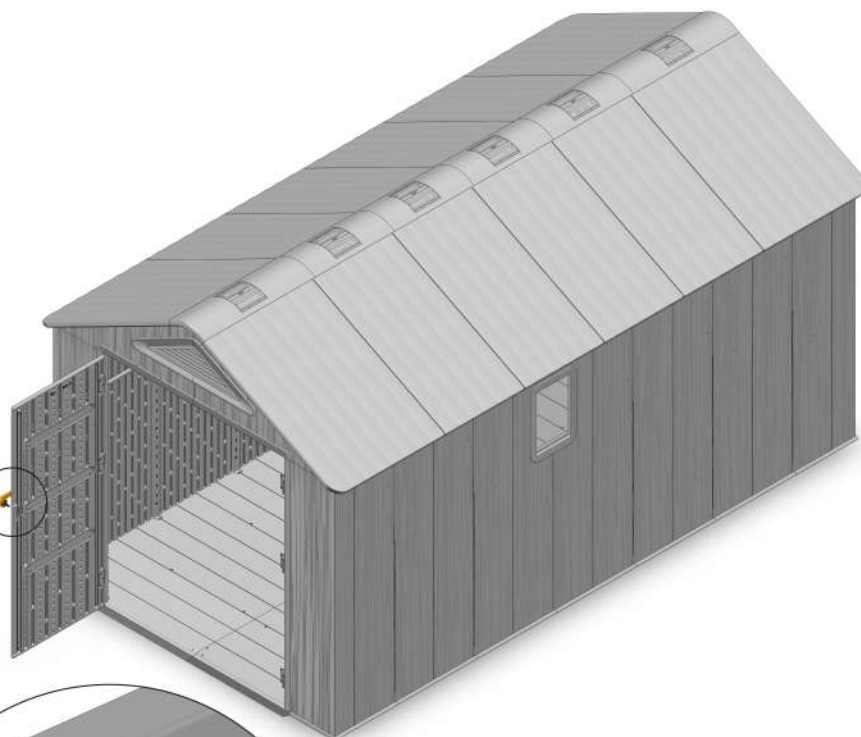
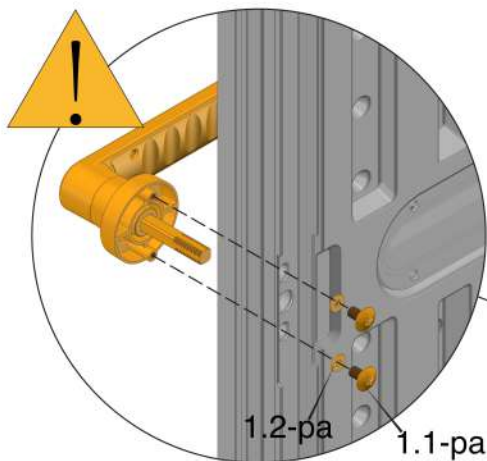

41

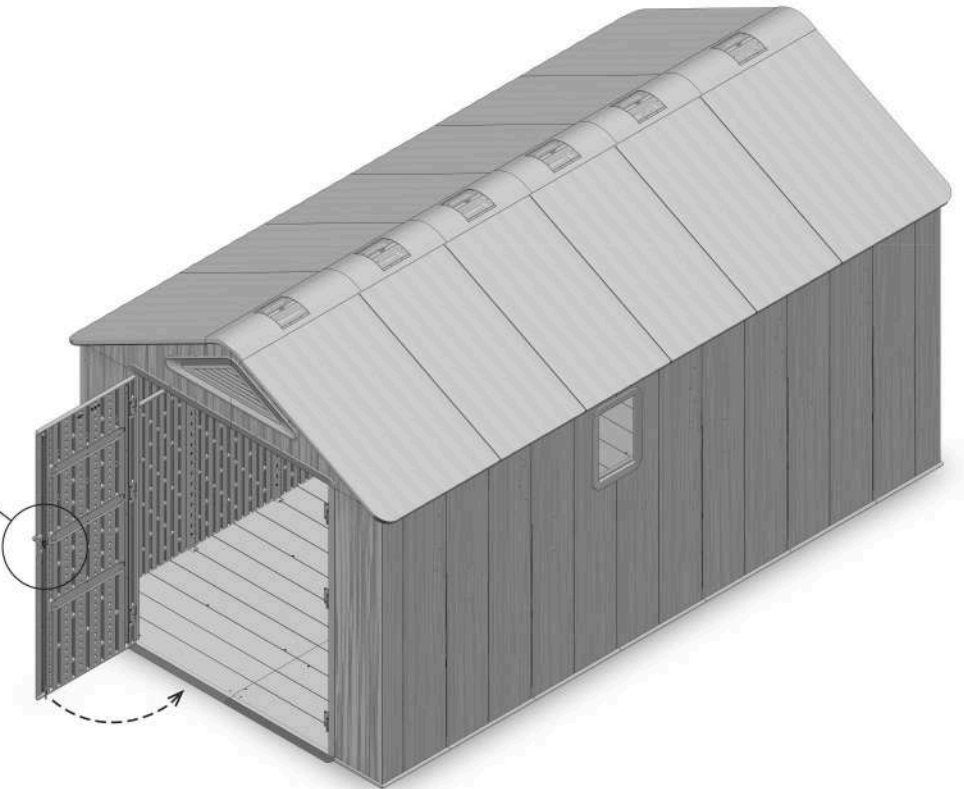
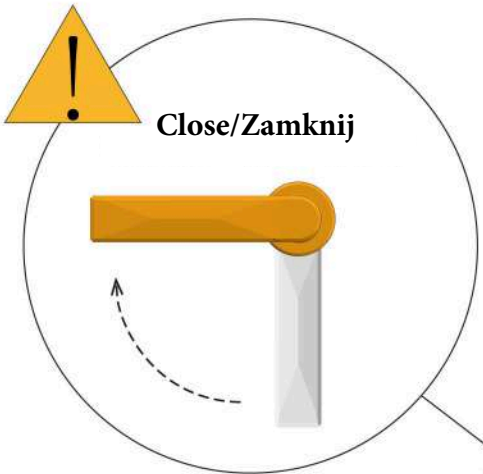
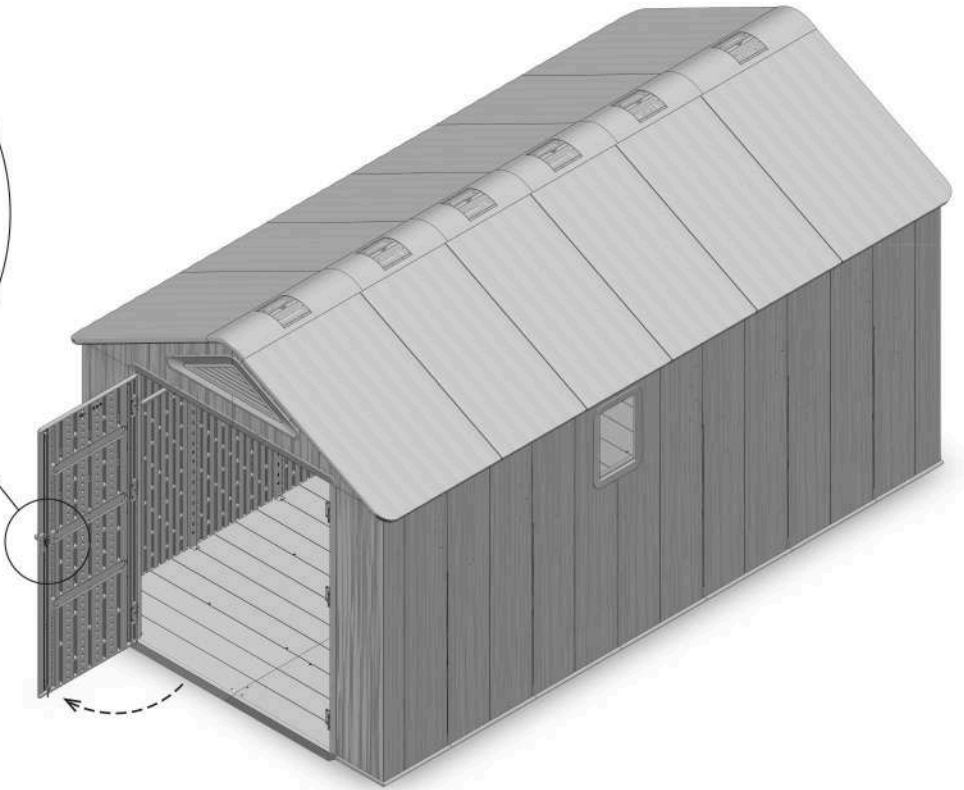
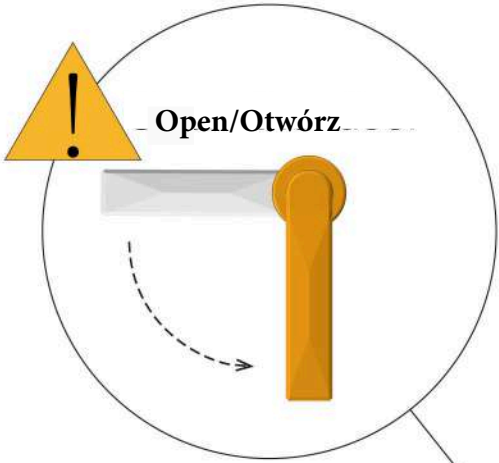

42



E53-pa x9

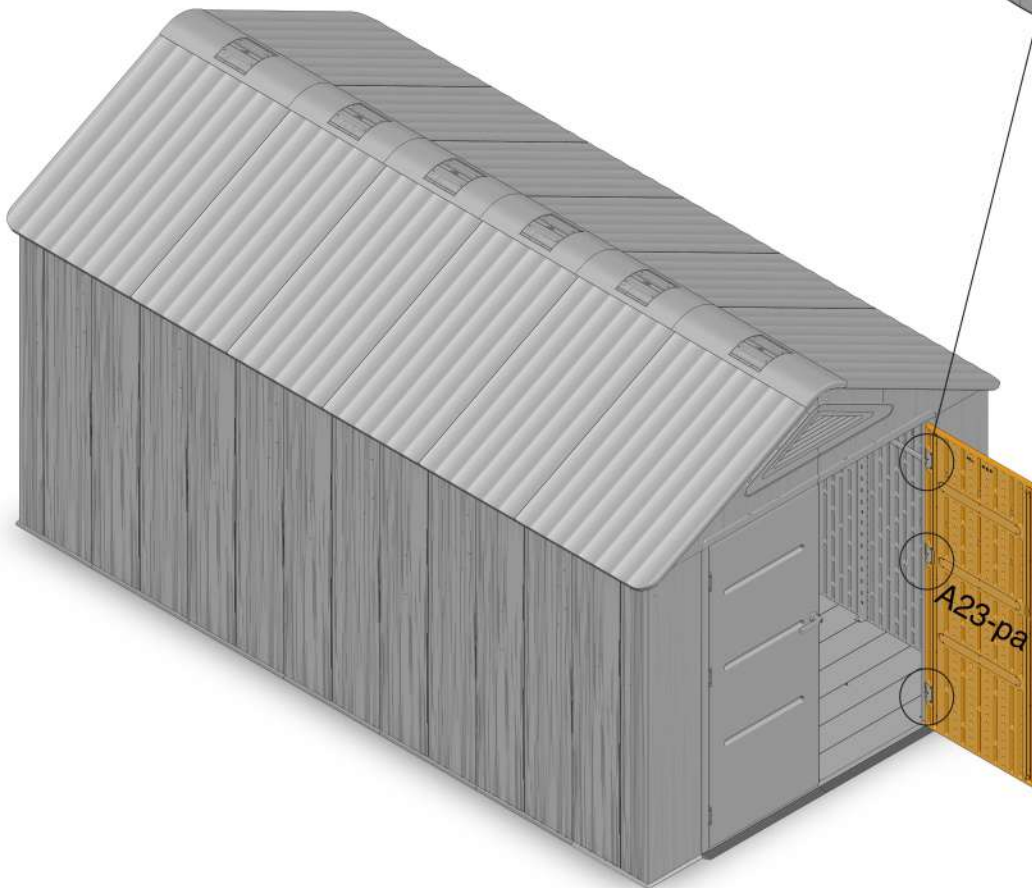
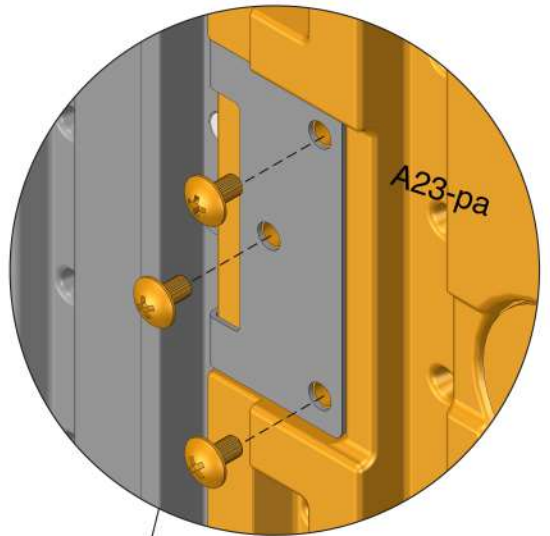

43



2-pa x1



1.1-pa x2



1.2-pa x2

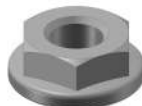

1.3-pa x1



1.4-pa x1



1.5-pa x1



8-pa x1

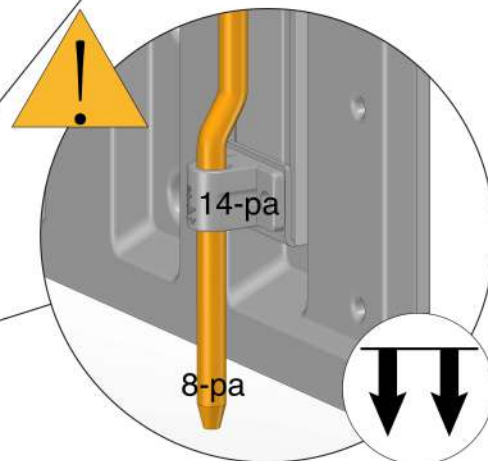
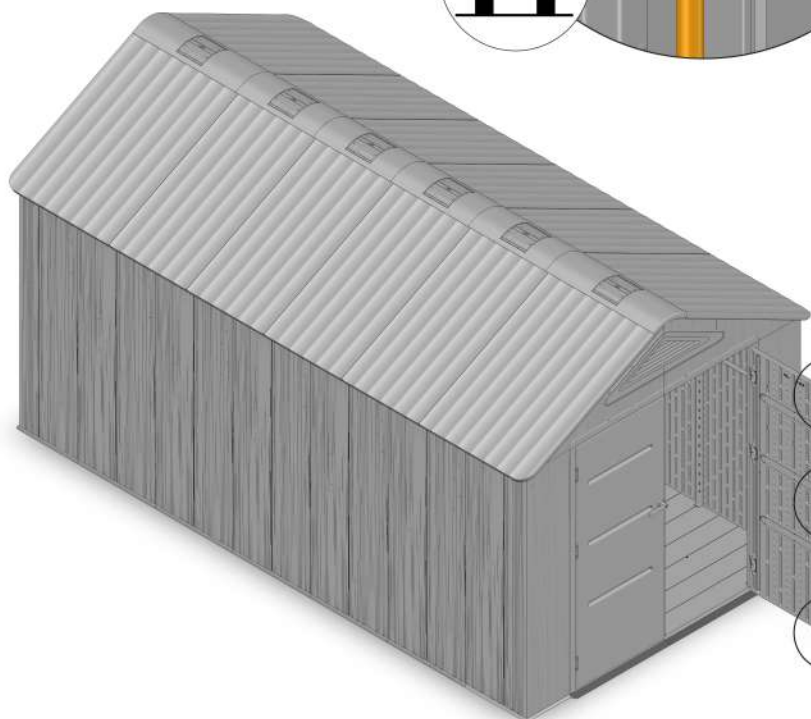
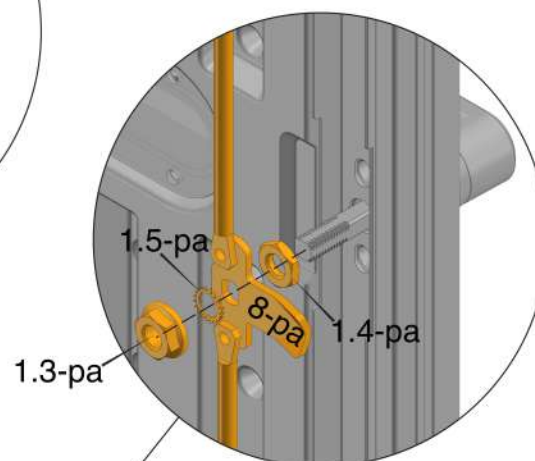
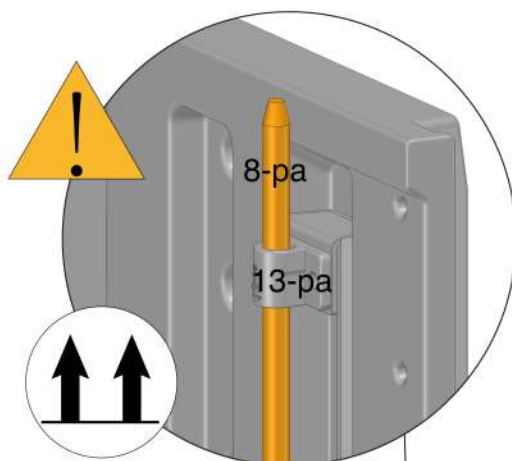
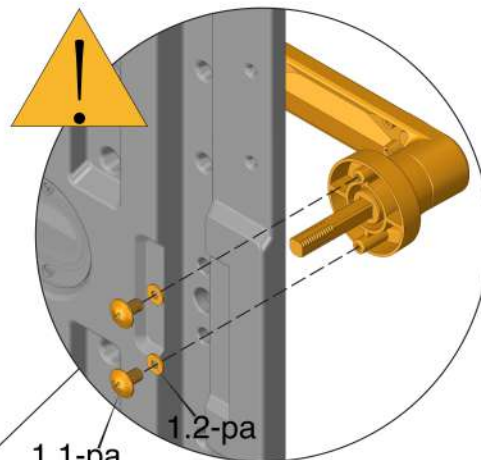
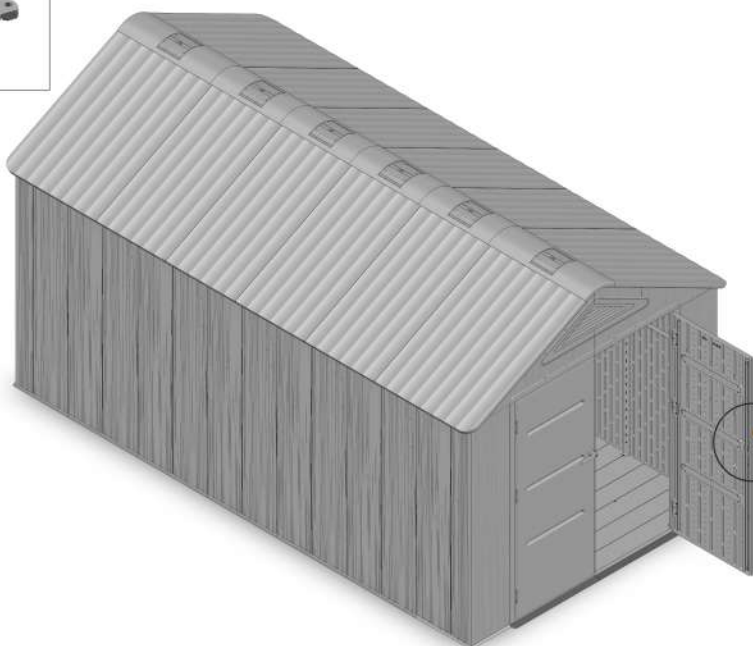

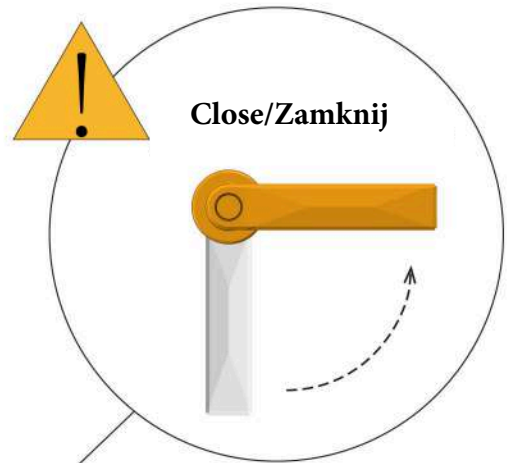
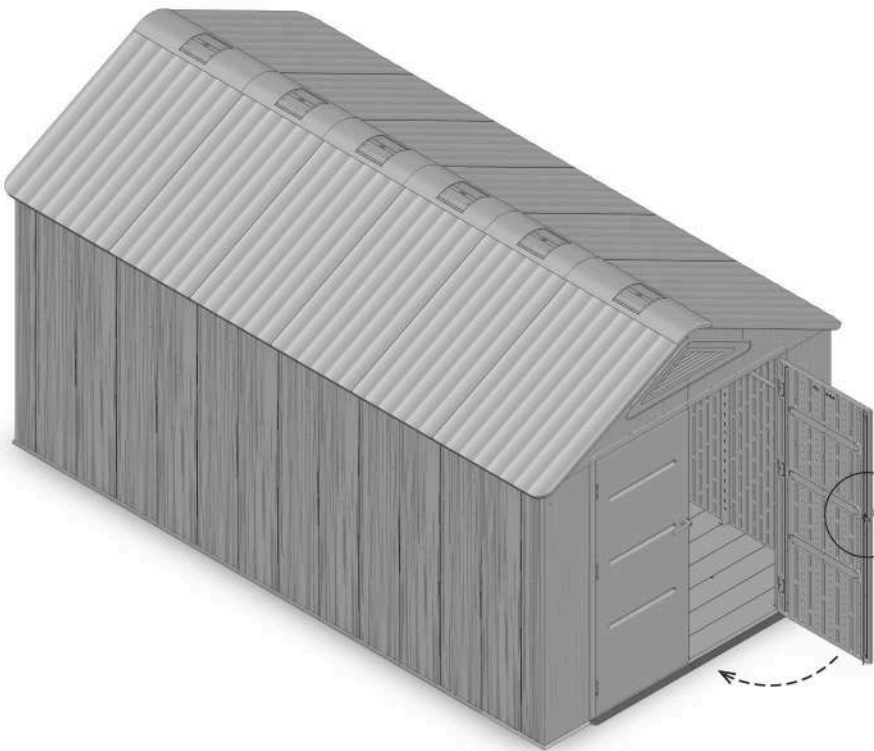
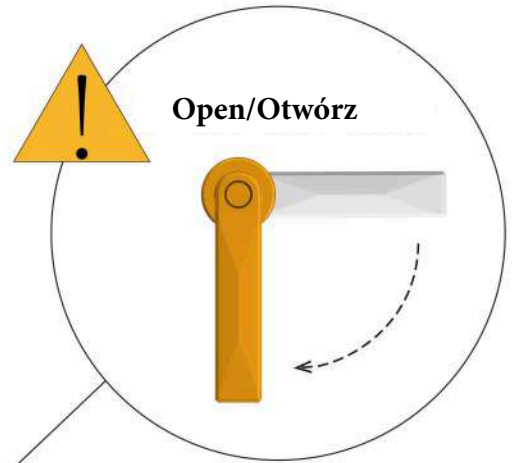
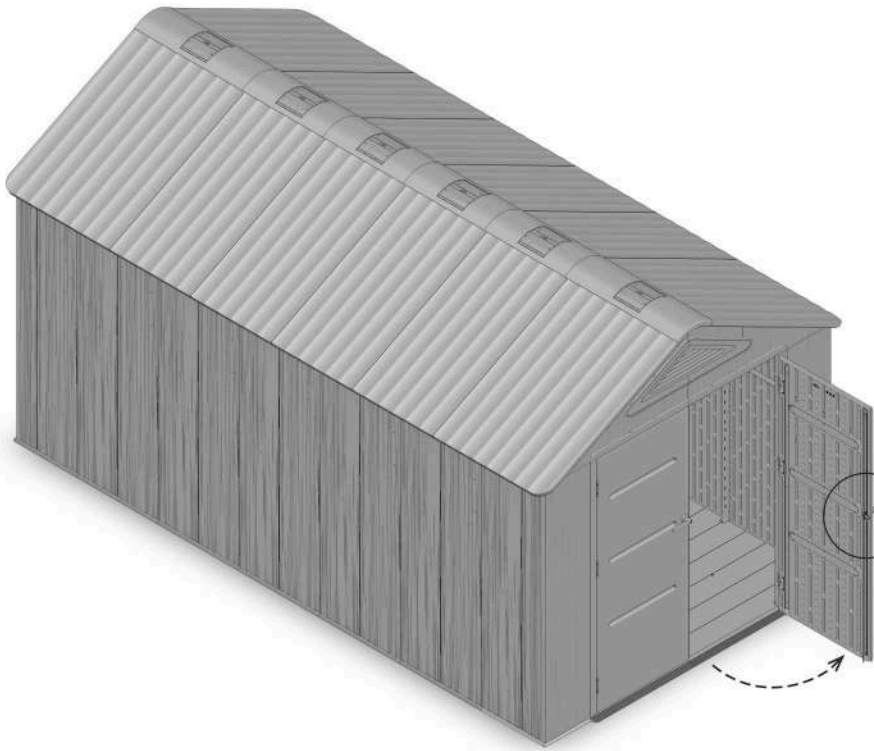

45



11-pa x5

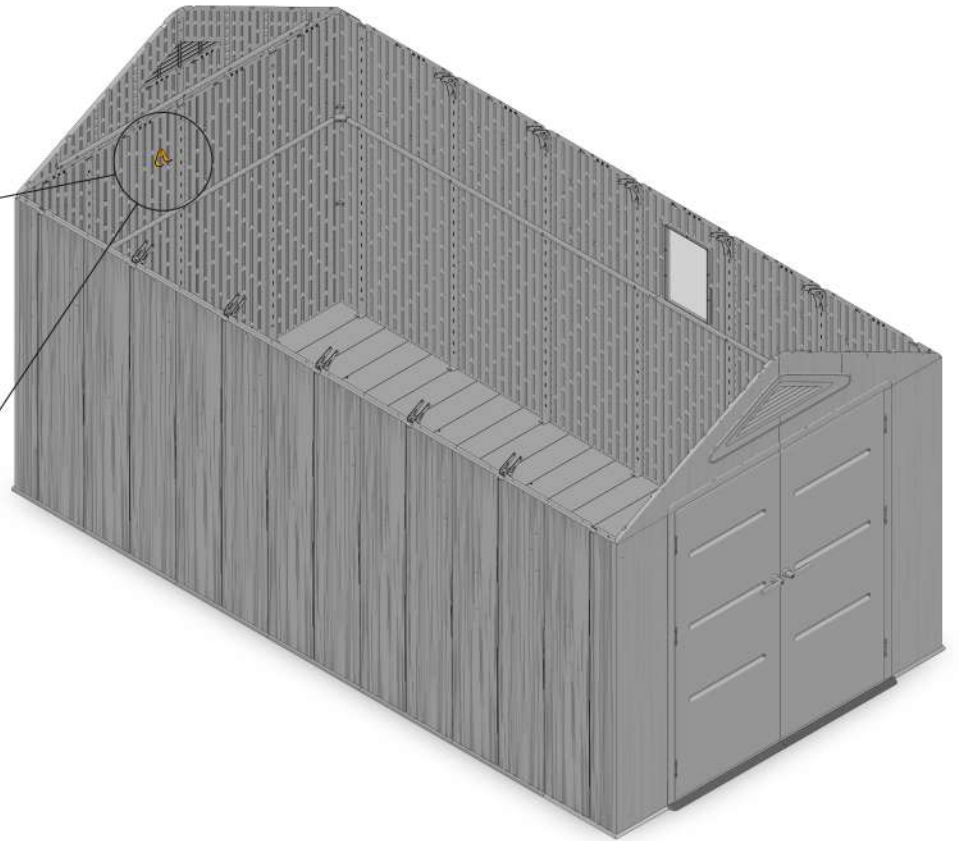
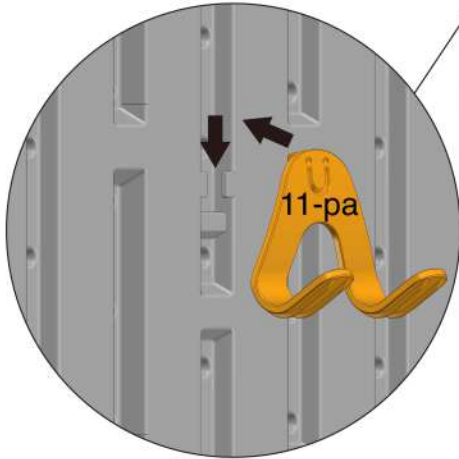
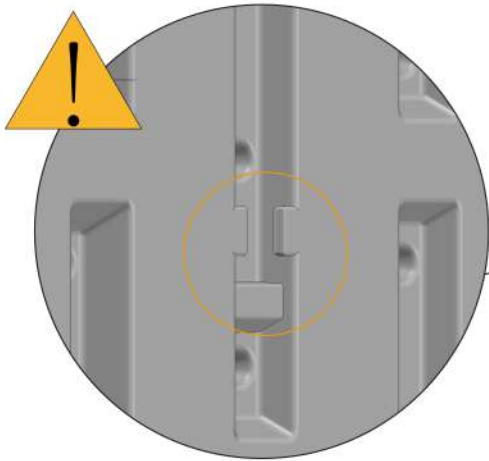

46



19-pa x2

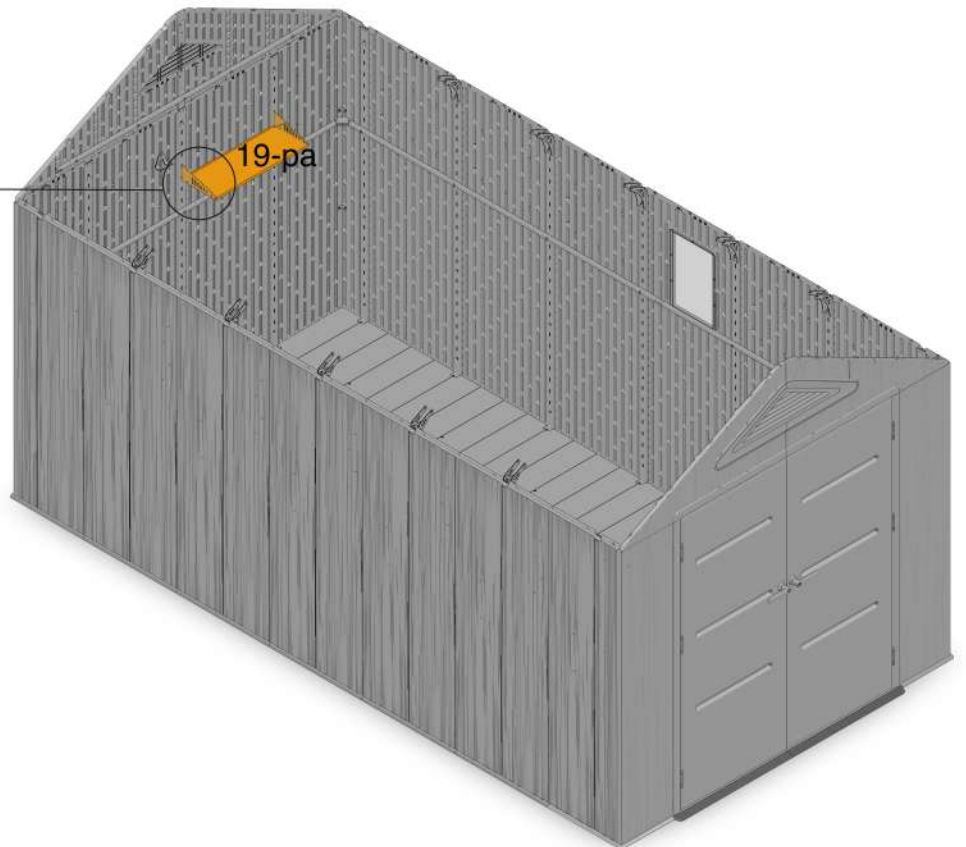
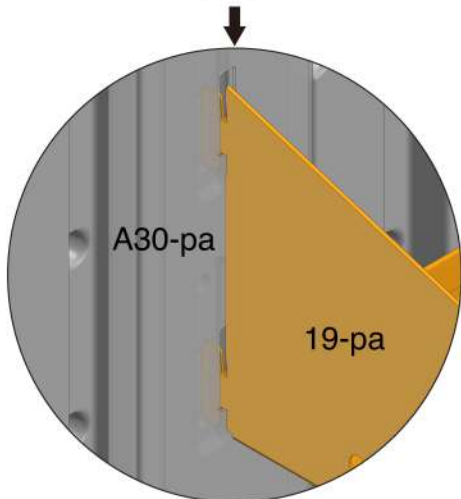
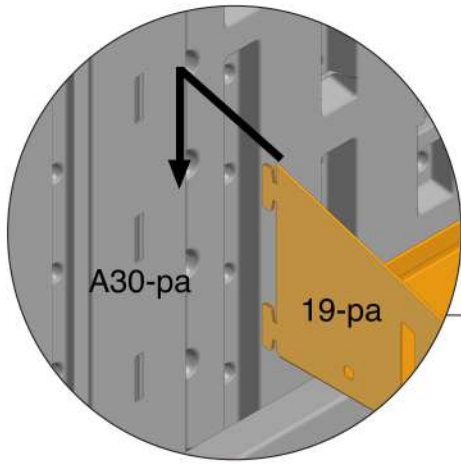
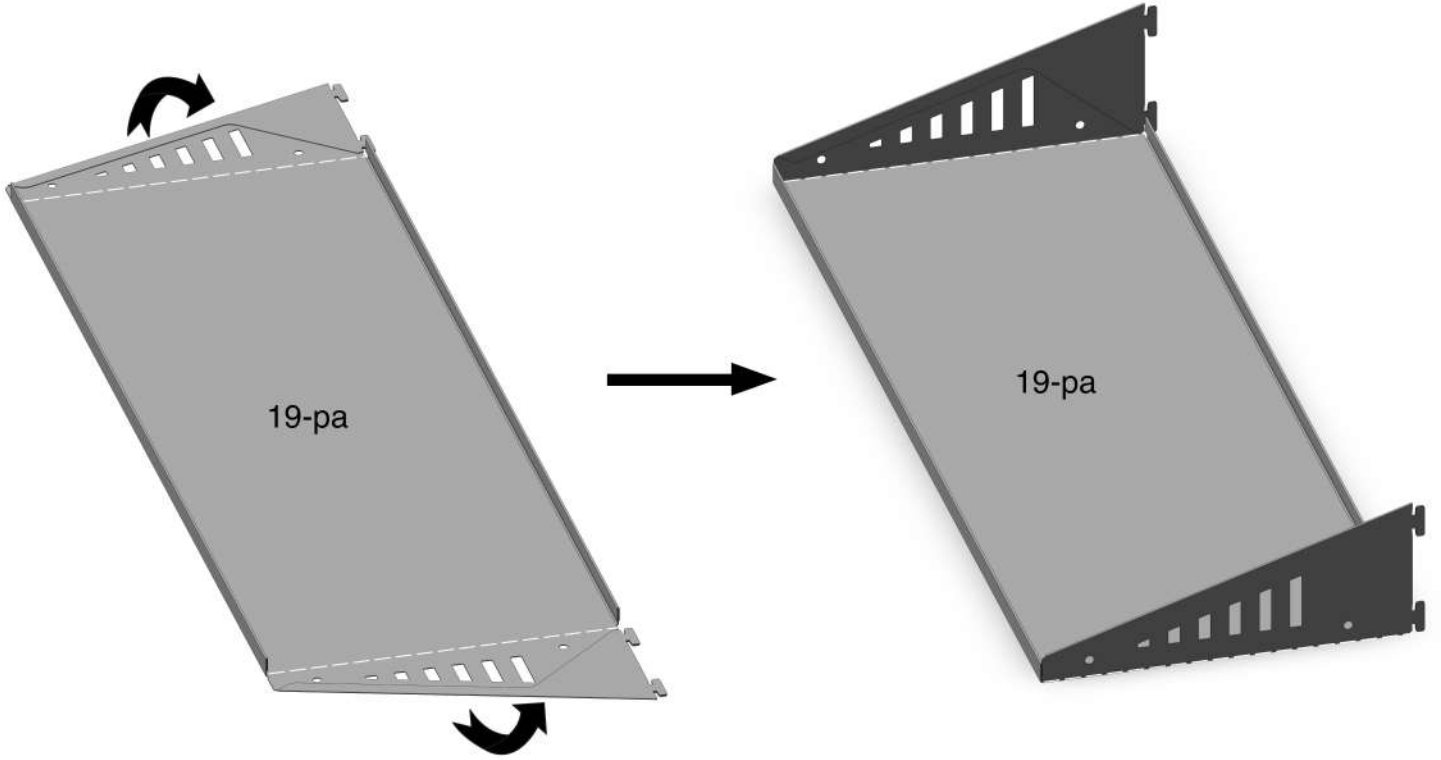

47



E60-pa x19

Montaż na drewnianej podstawie/ Assembly on a wooden base

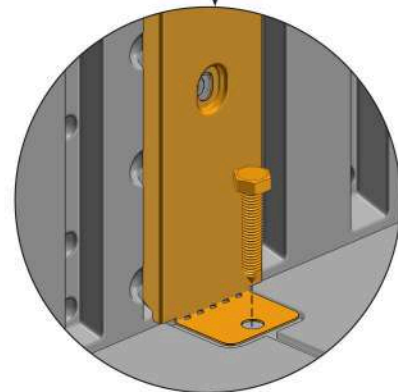
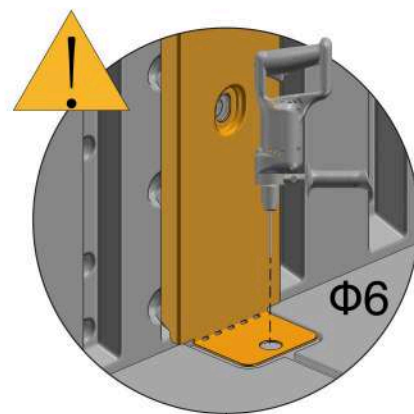
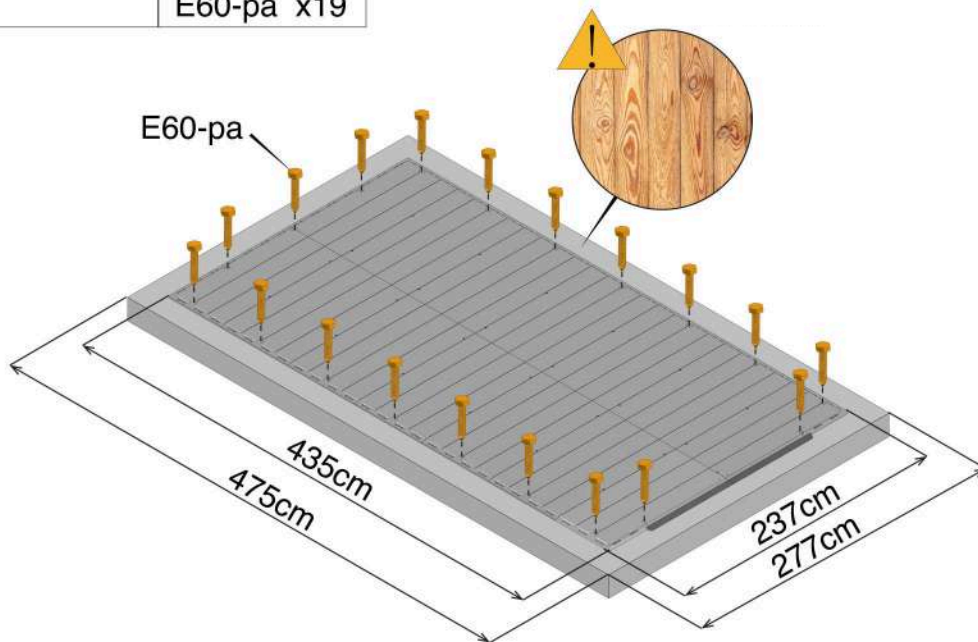

Montaż na betonowej podstawie/ Assembly on a concrete base

