

EVEREST 8x12 Domek z tworzywa/Plastic shed

Instrukcja montażu/Assembly instructions

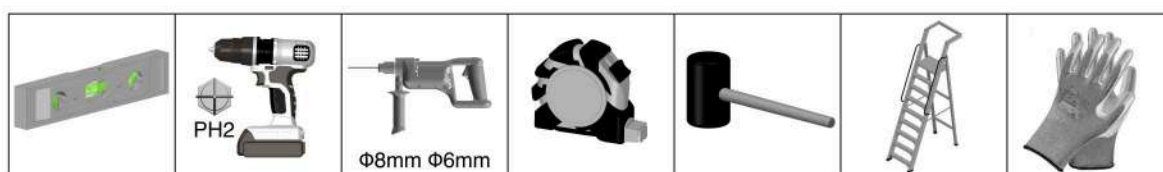

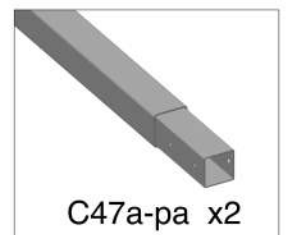

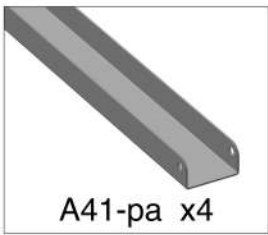
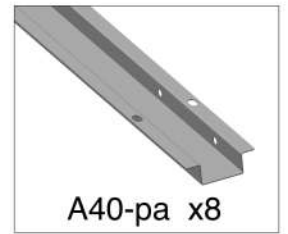
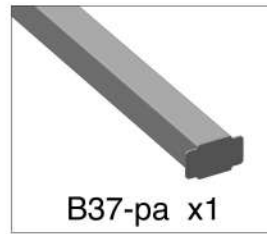
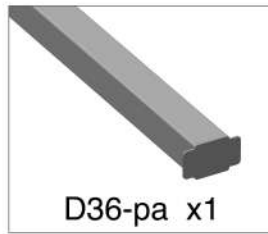
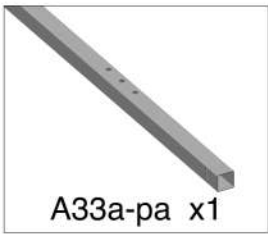
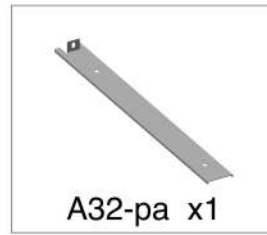
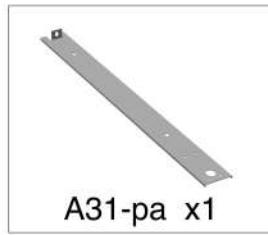
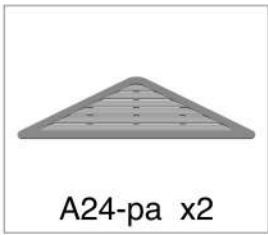
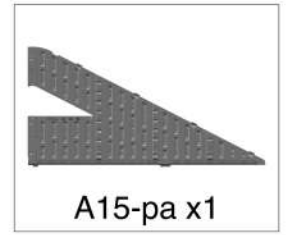
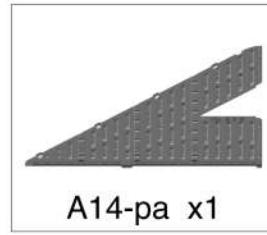
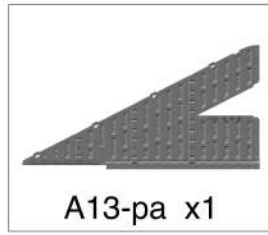
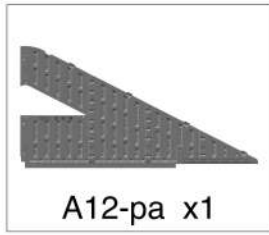
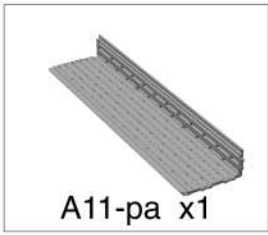
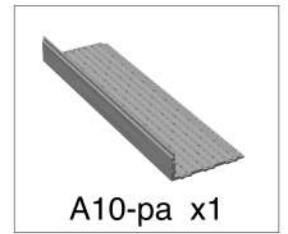
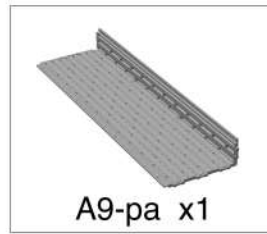
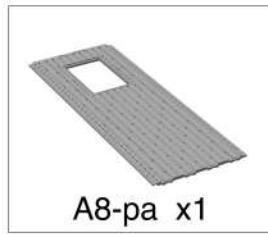
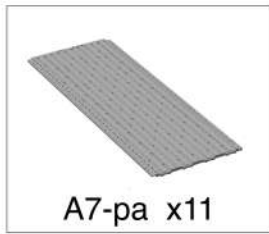
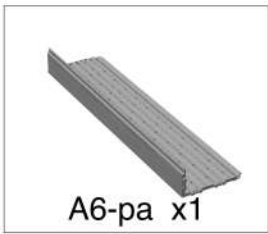
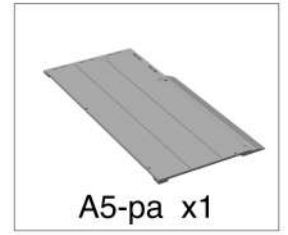
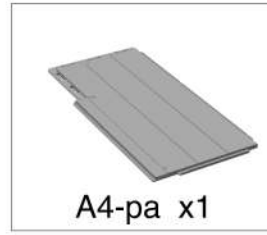
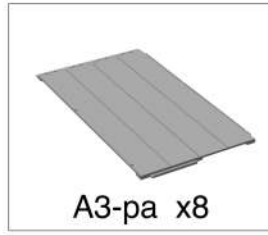
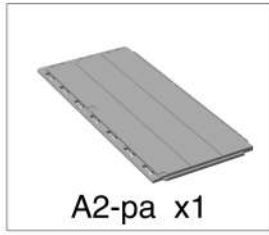
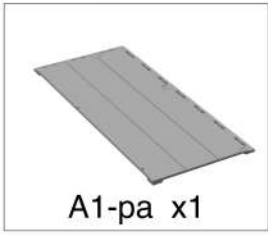
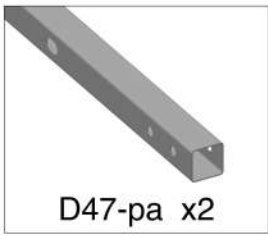

D47-pa x2

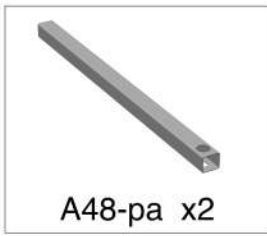

A48-pa x2

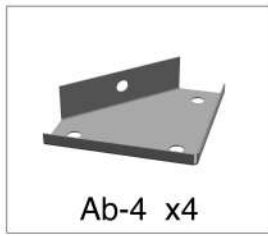

Ab-4 x4

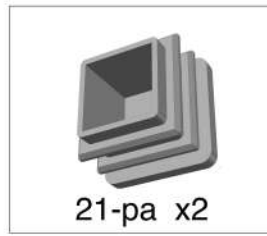

21-pa x2

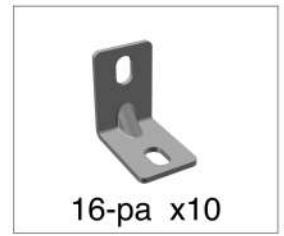

16-pa x10

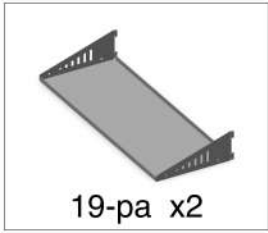

19-pa x2

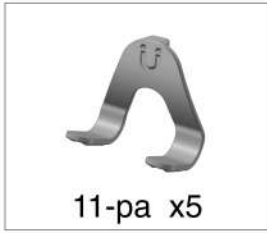

11-pa x5

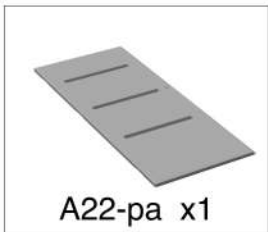

A22-pa x1

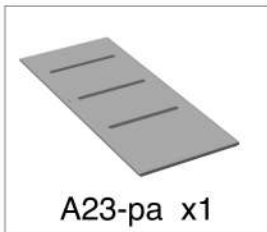

A23-pa x1



A34-pa x2

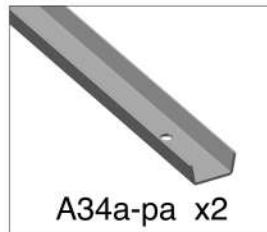

A34a-pa x2



7-pa x1



8-pa x1



13-pa x2



14-pa x2



15-pa x6



1-pa x1

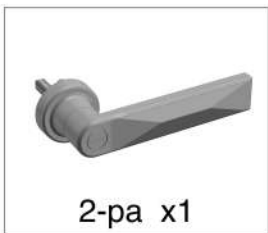

2-pa x1



M4x16mm

1.1-pa x4

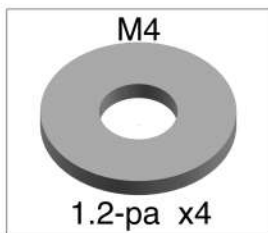

M4

1.2-pa x4

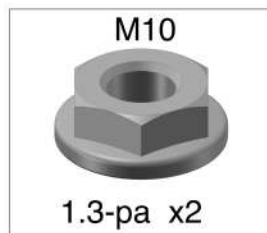

M10

1.3-pa x2

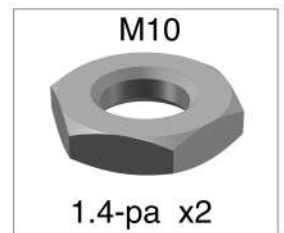

M10

1.4-pa x2



M10

1.5-pa x2

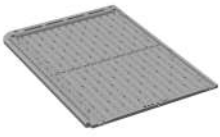

A16-pa x2

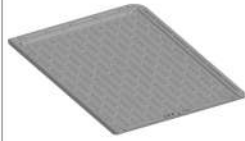

A17-pa x2



A18-pa x6



A44-pa x4



A45-pa x6



A19-pa x1



A20-pa x1



A21-pa x3

M4x10mm



D50-pa x18

ST4x12mm



D51-pa x60

ST4.2x13mm



D52-pa x4

M6x10mm



D53-pa x96

M6x18mm



D54-pa x51

M6x25mm



D55-pa x15

M6x40mm



D56-pa x6

ST6x12mm



D57-pa x20

ST6x16mm



D58-pa x153

ST6x20mm



D59-pa x74

ST8x60mm



D60-pa x17

M6



D61-pa x50

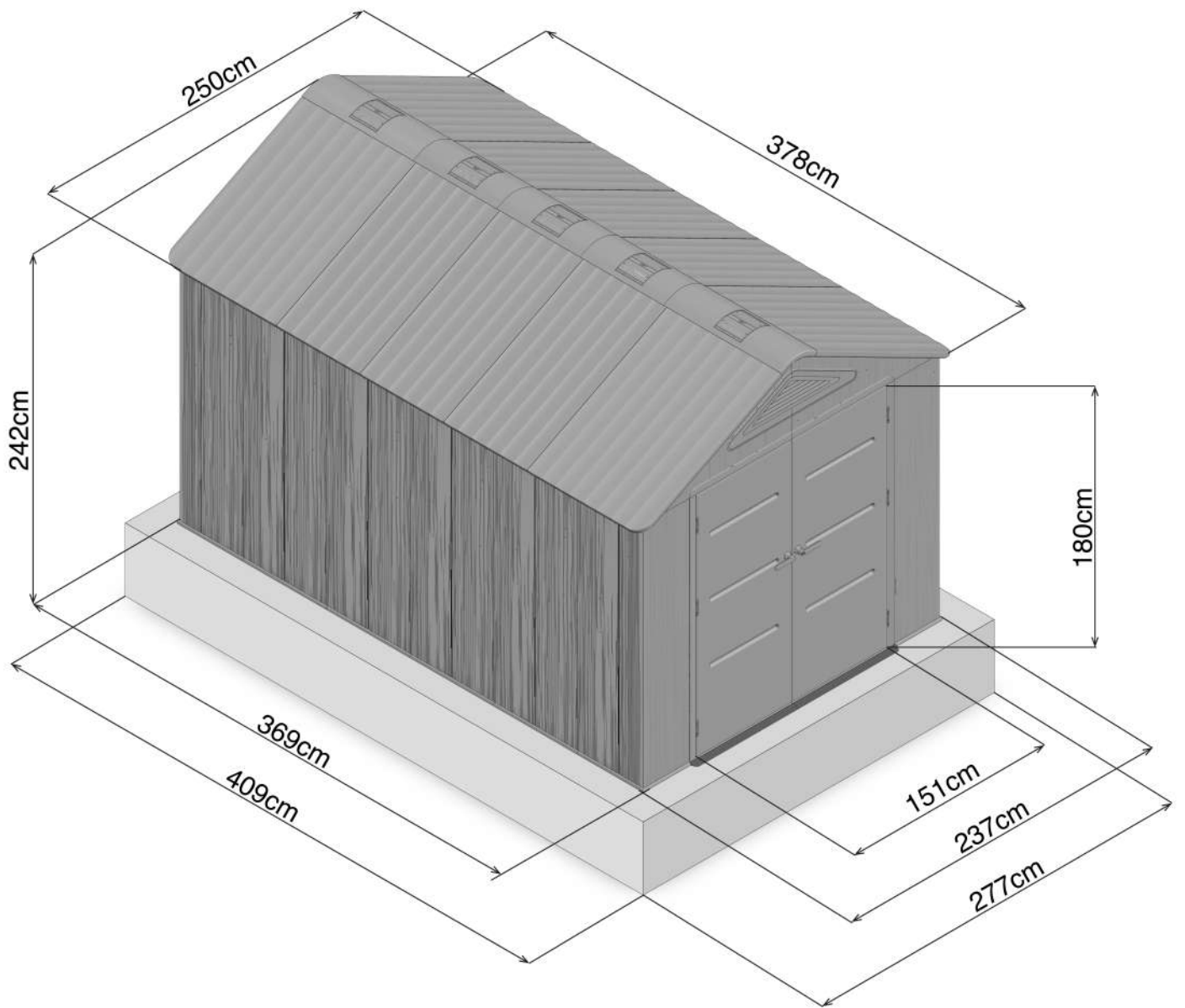

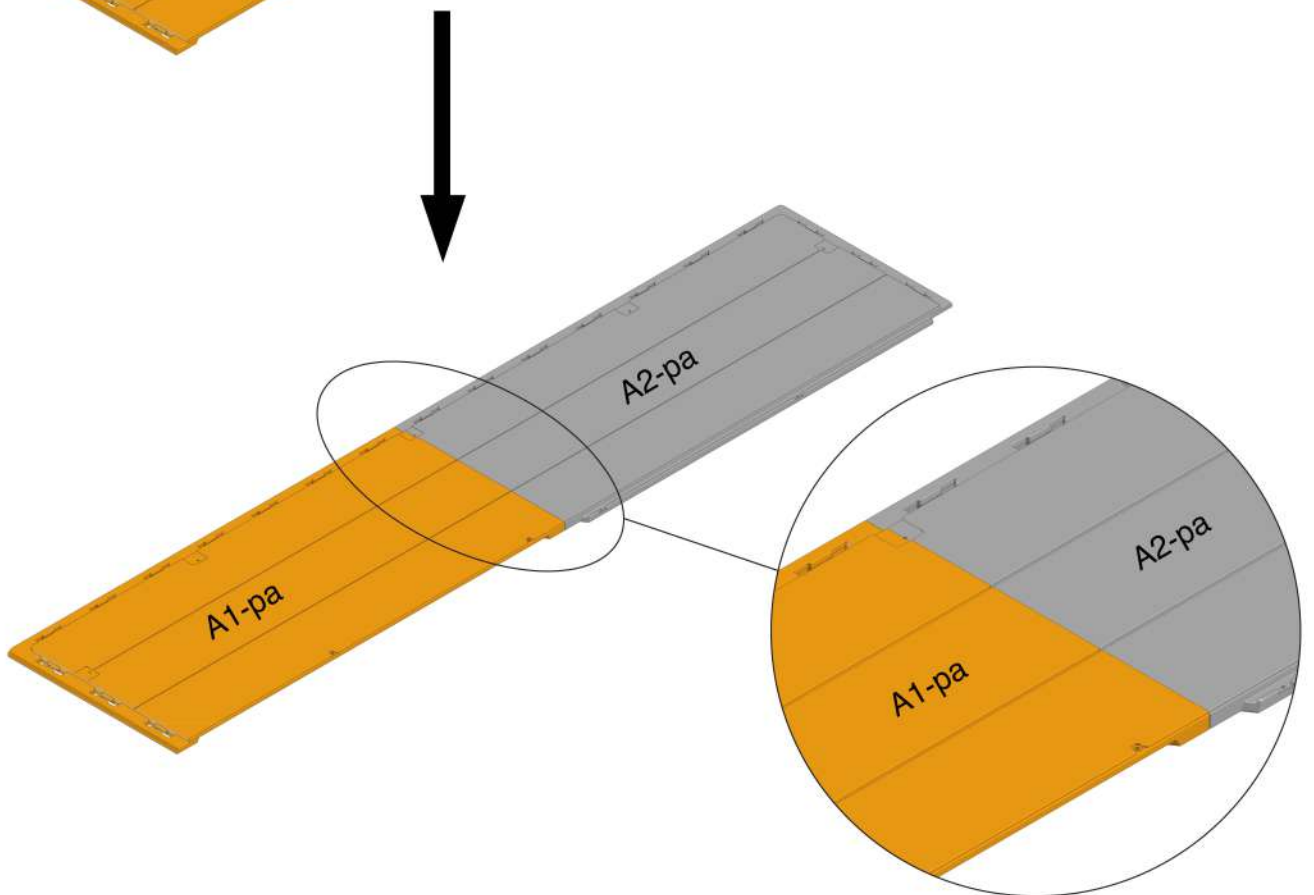
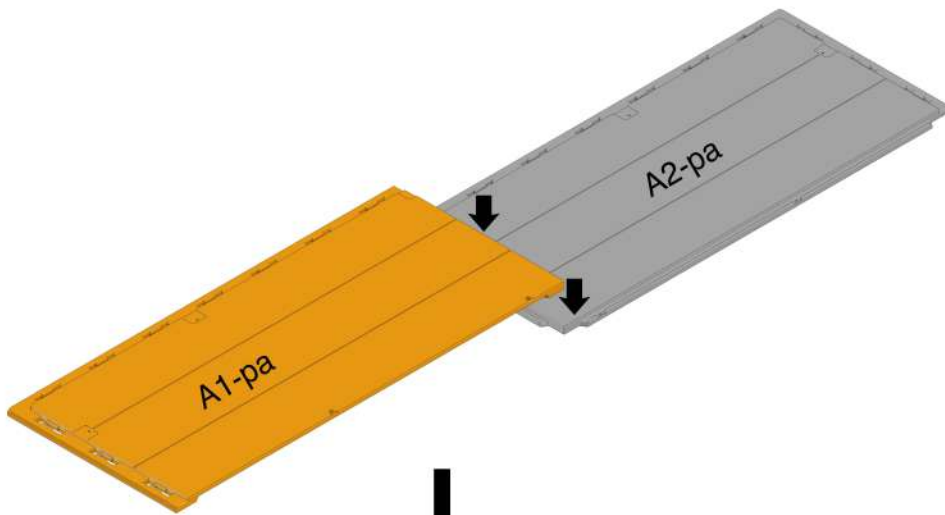
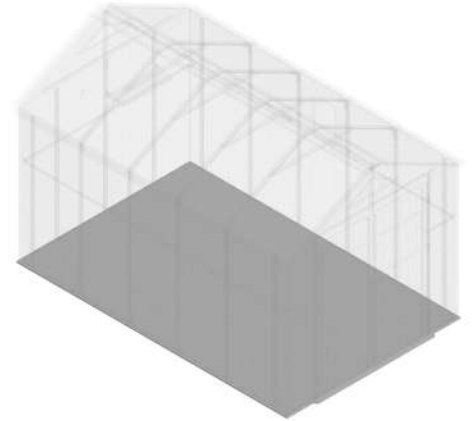
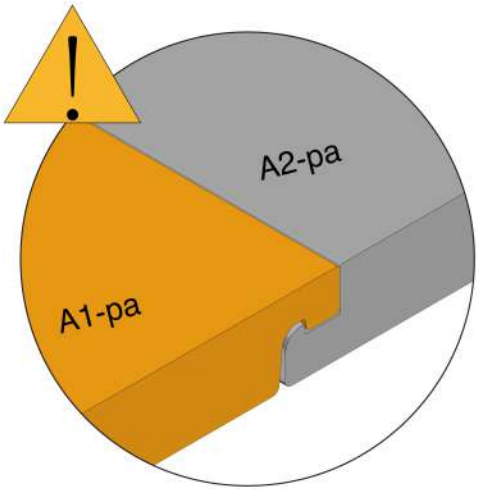
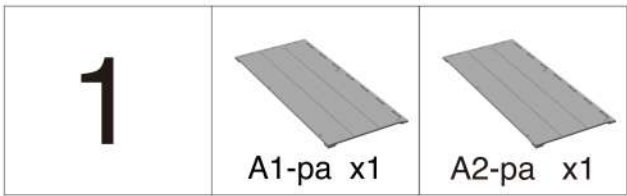

2



A3-pa x2

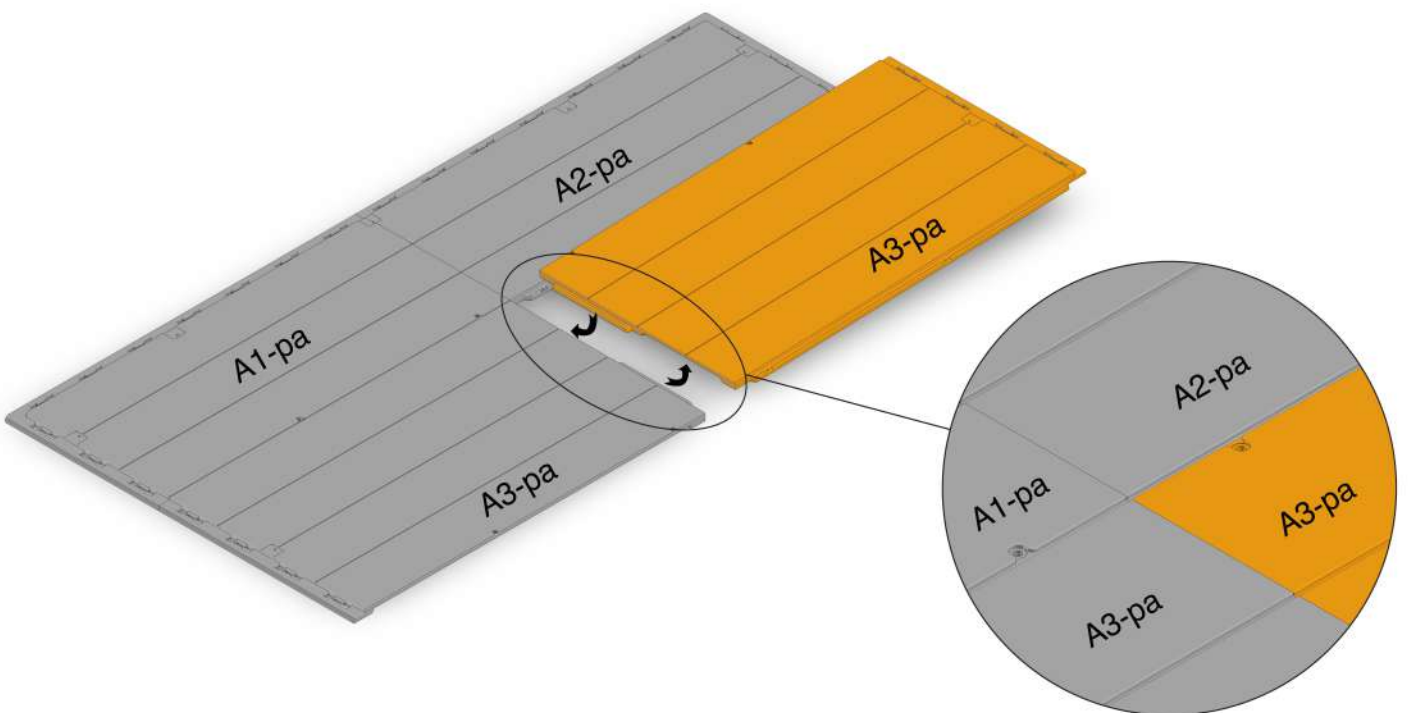
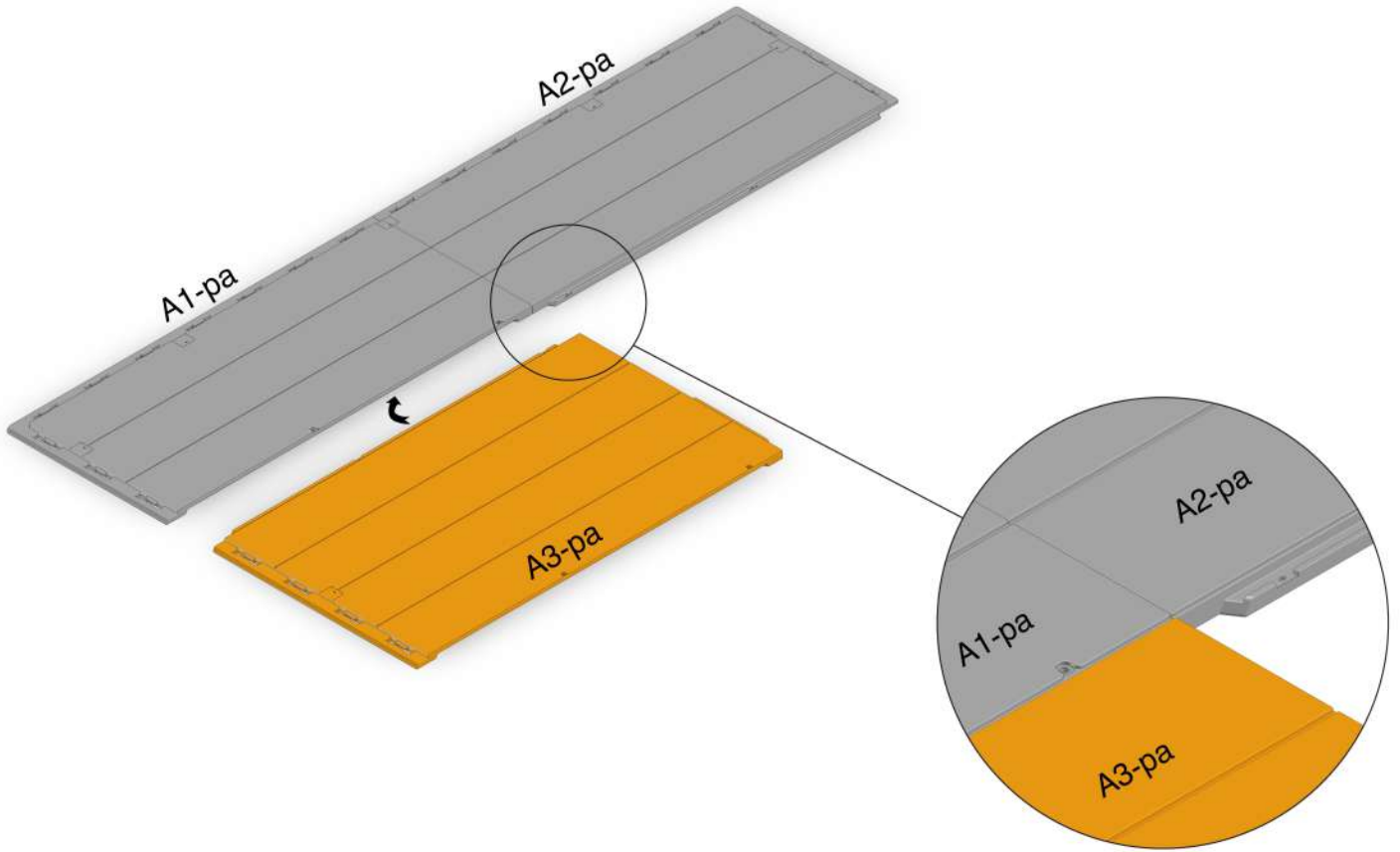

3



A3-pa x6

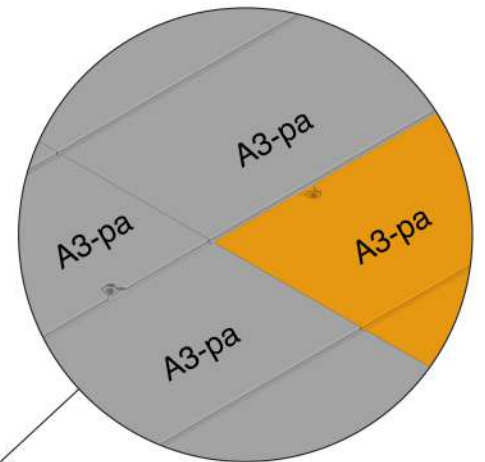
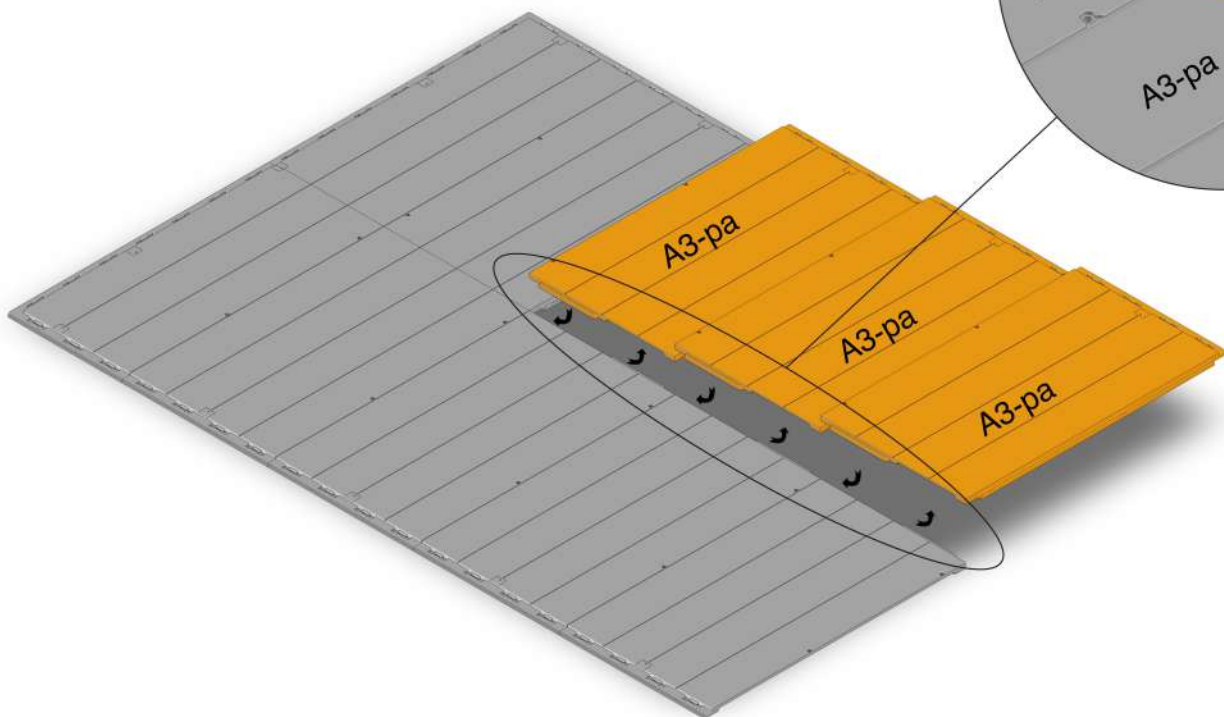
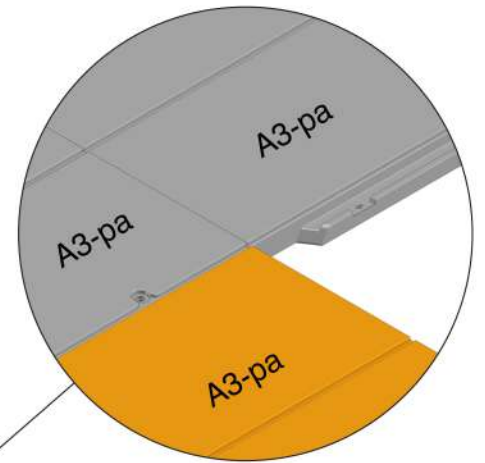
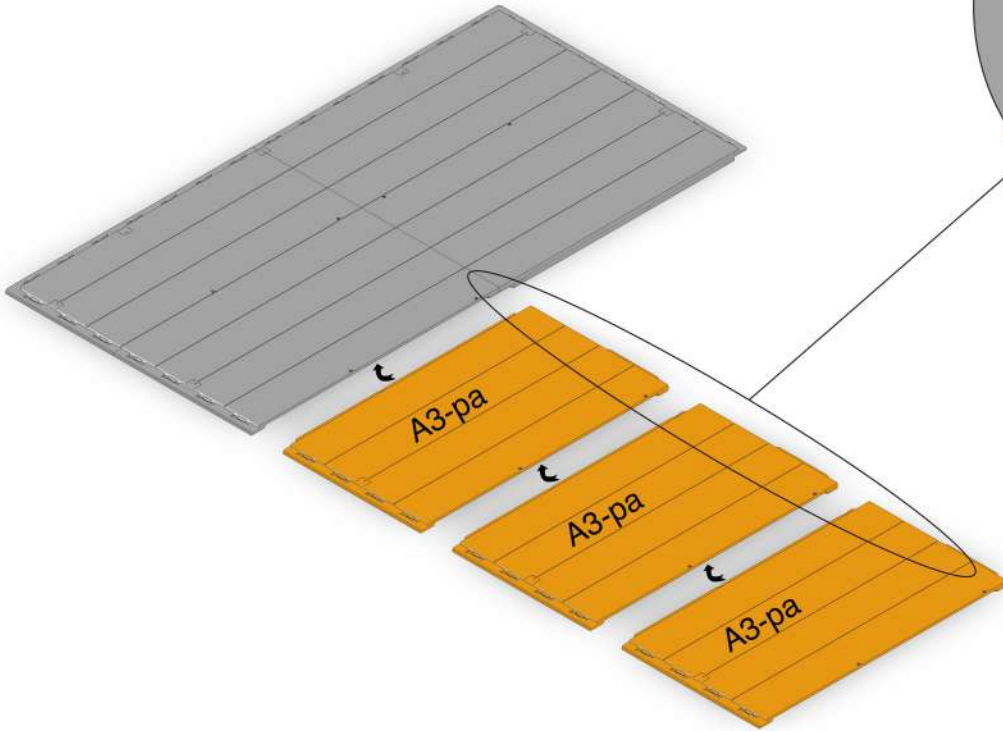

4



A4-pa x1



A5-pa x1



D58-pa x21

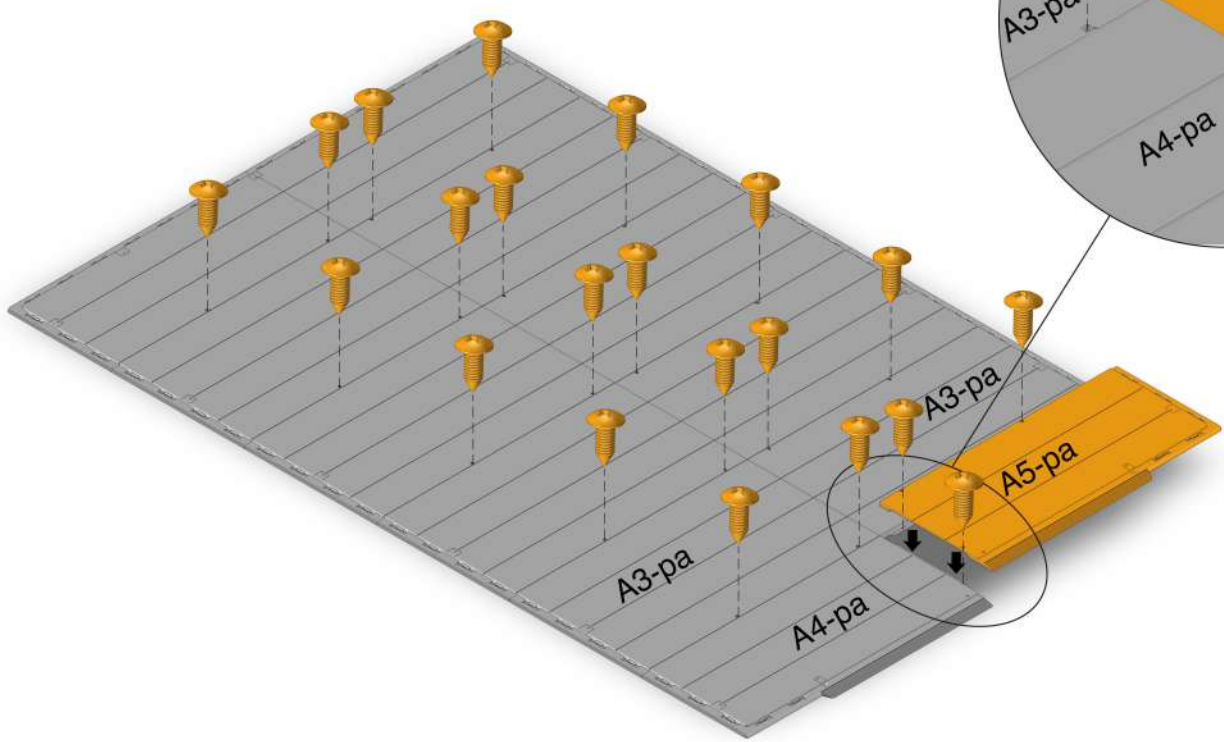
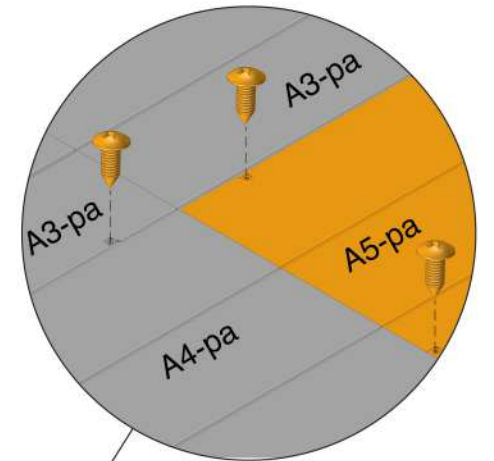
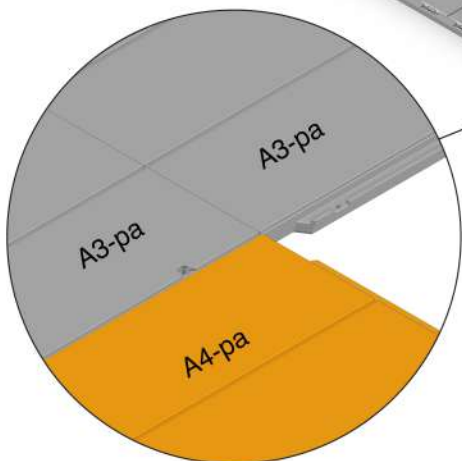
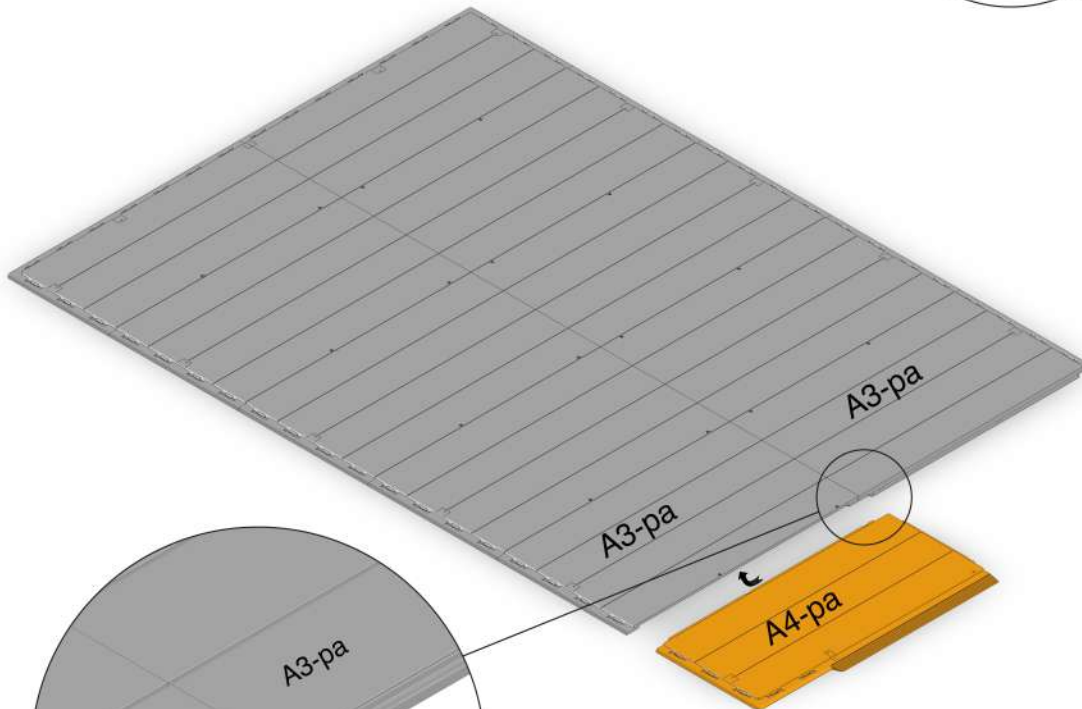

5



A6-pa x1

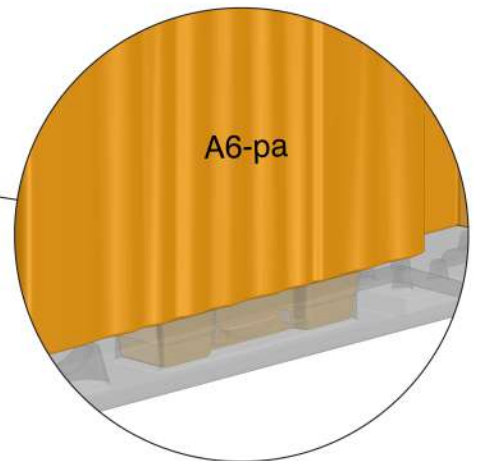
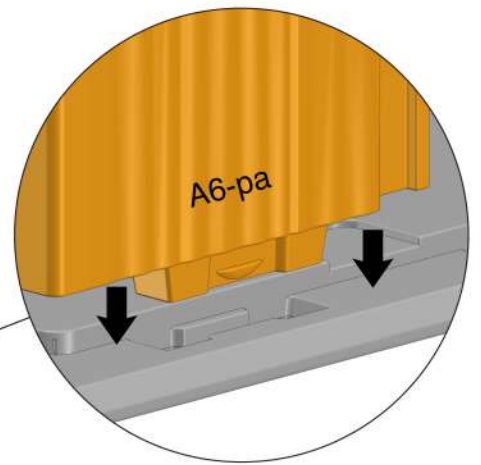
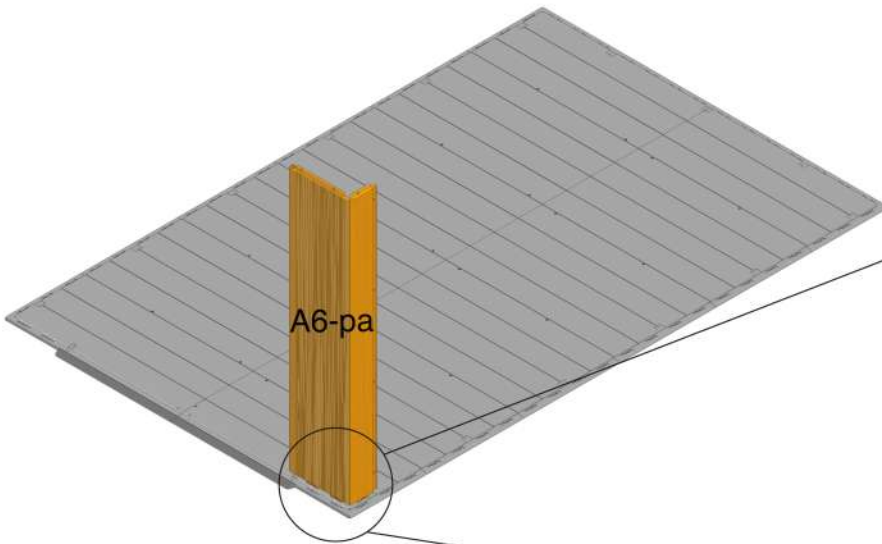
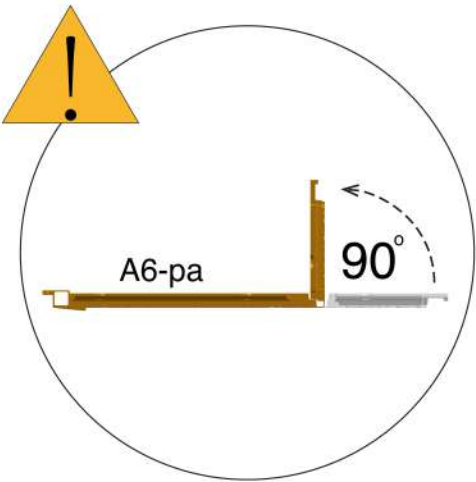
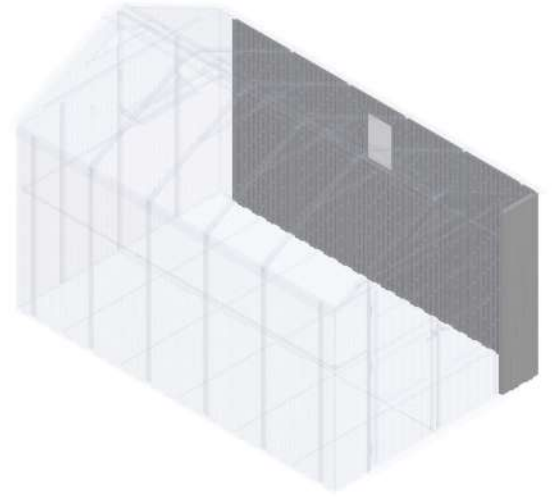

6



A7-pa x1

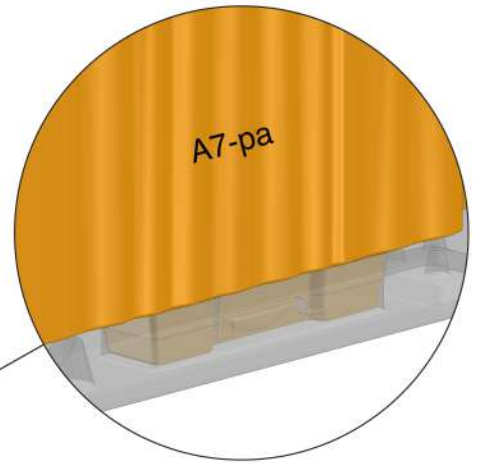
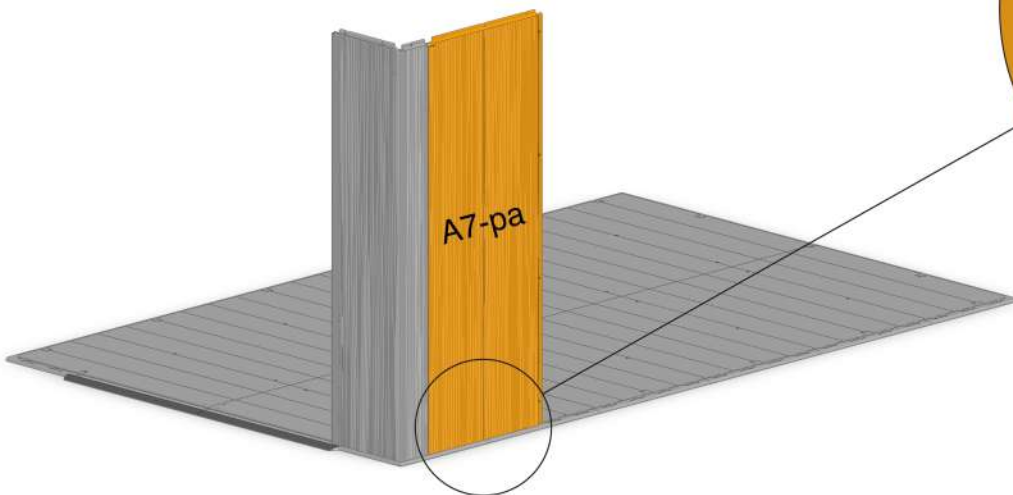
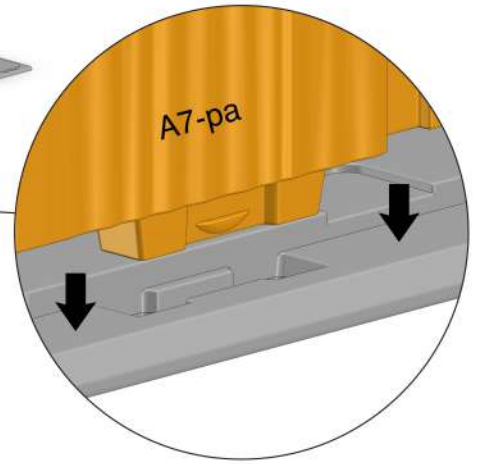
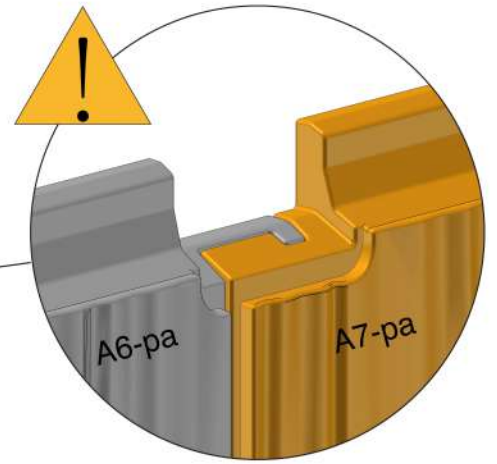
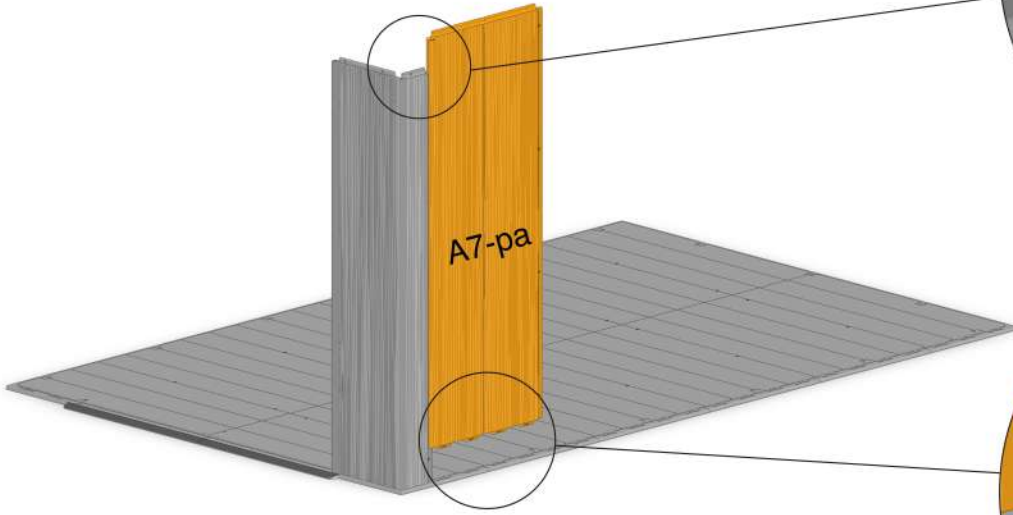

7



A7-pa x1

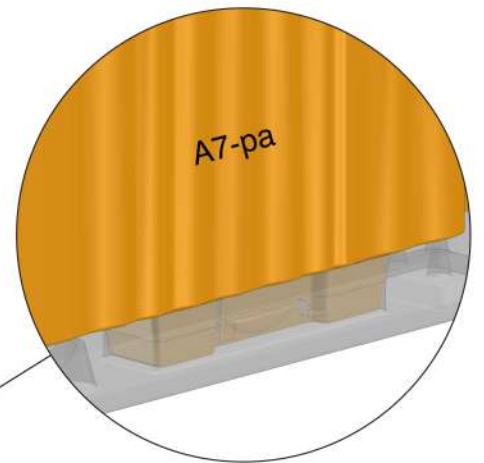
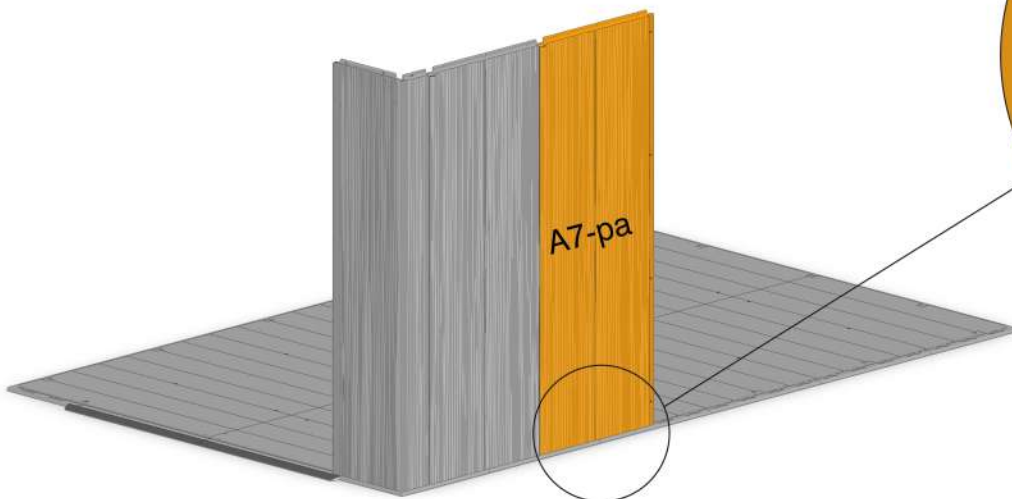
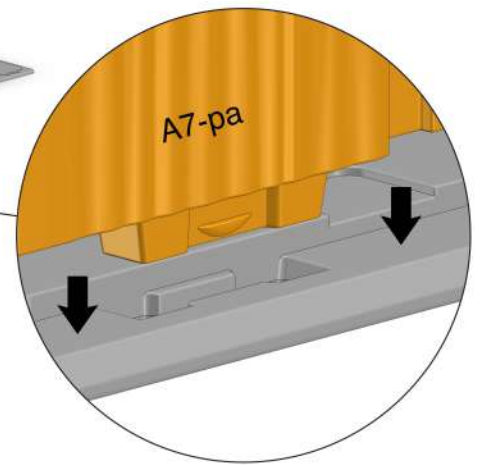
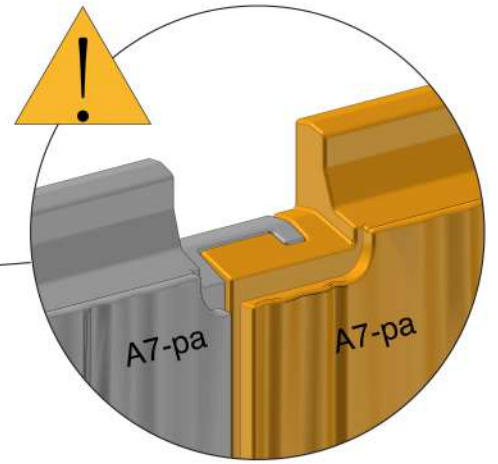
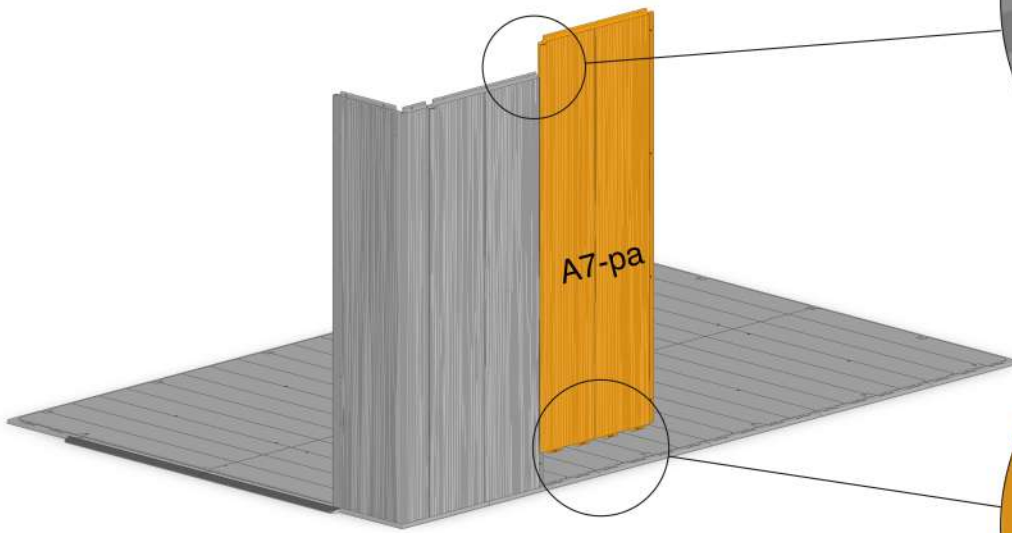

8



A8-pa x1

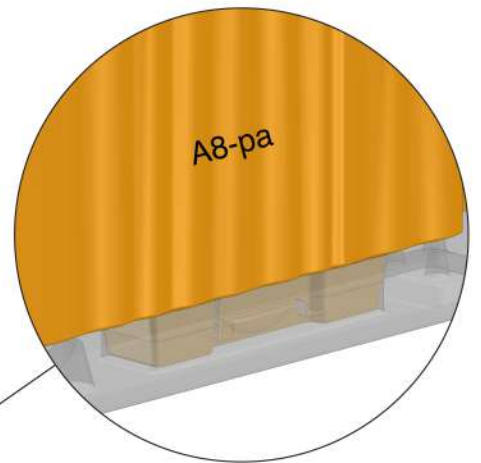
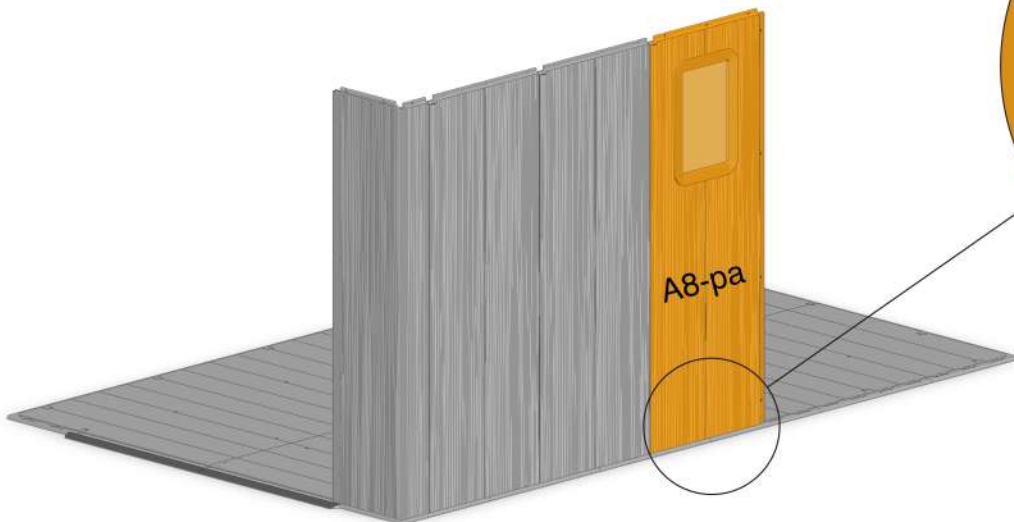
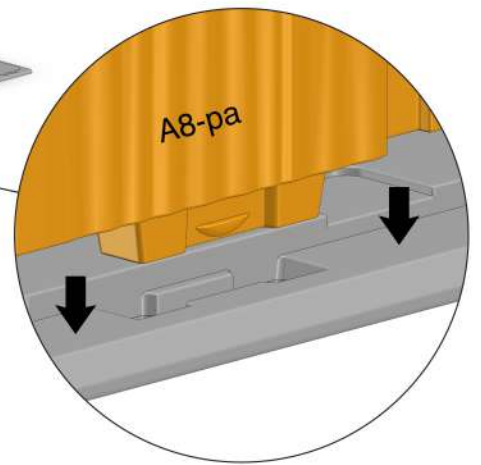
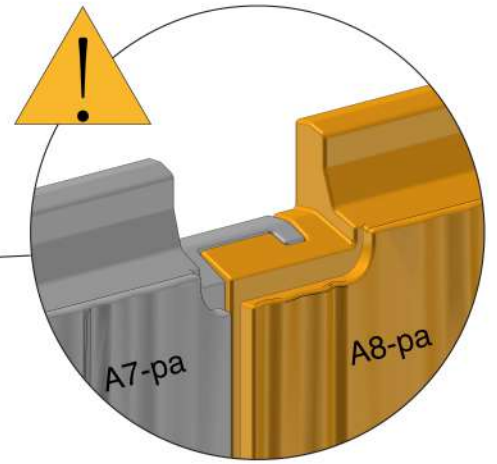
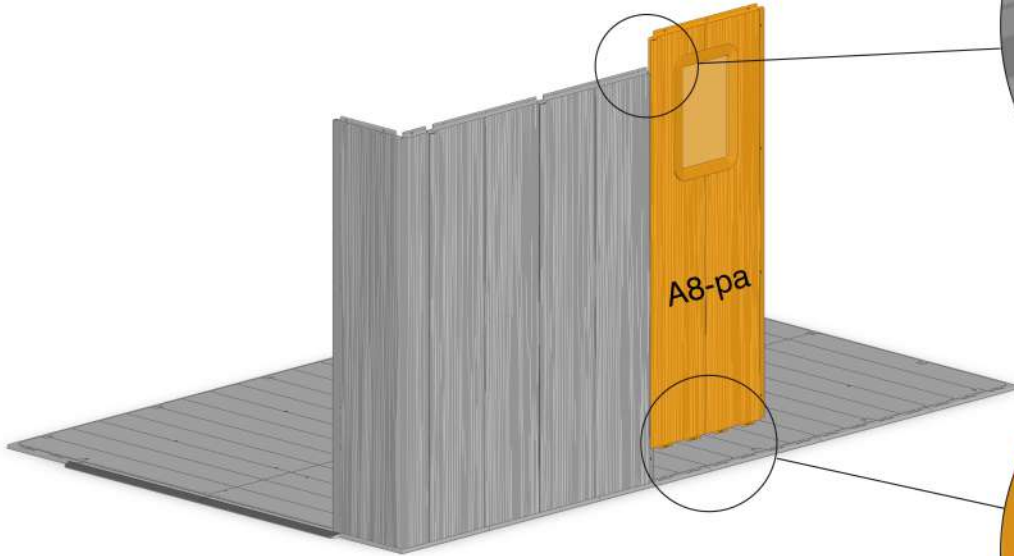

9

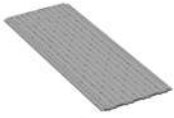

A7-pa x2

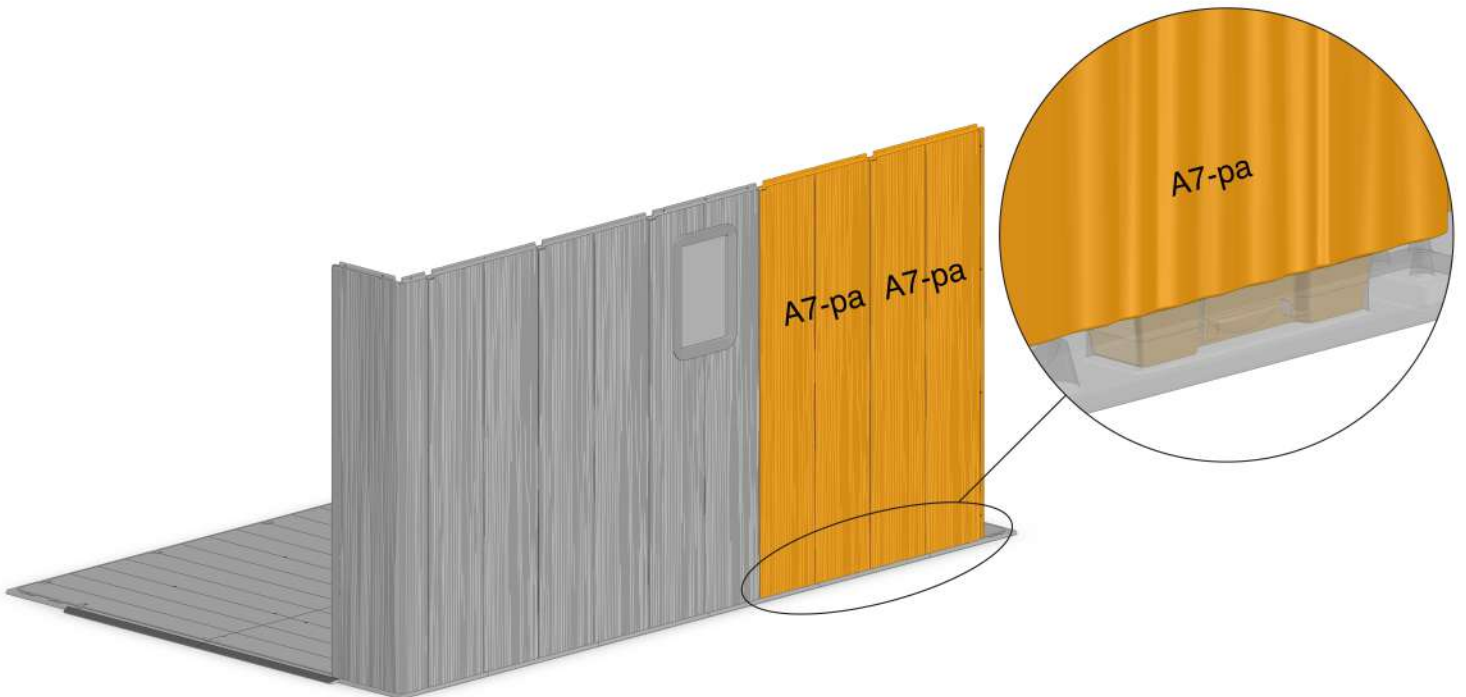
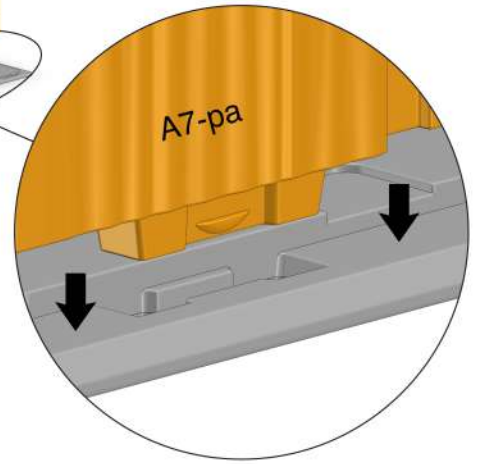
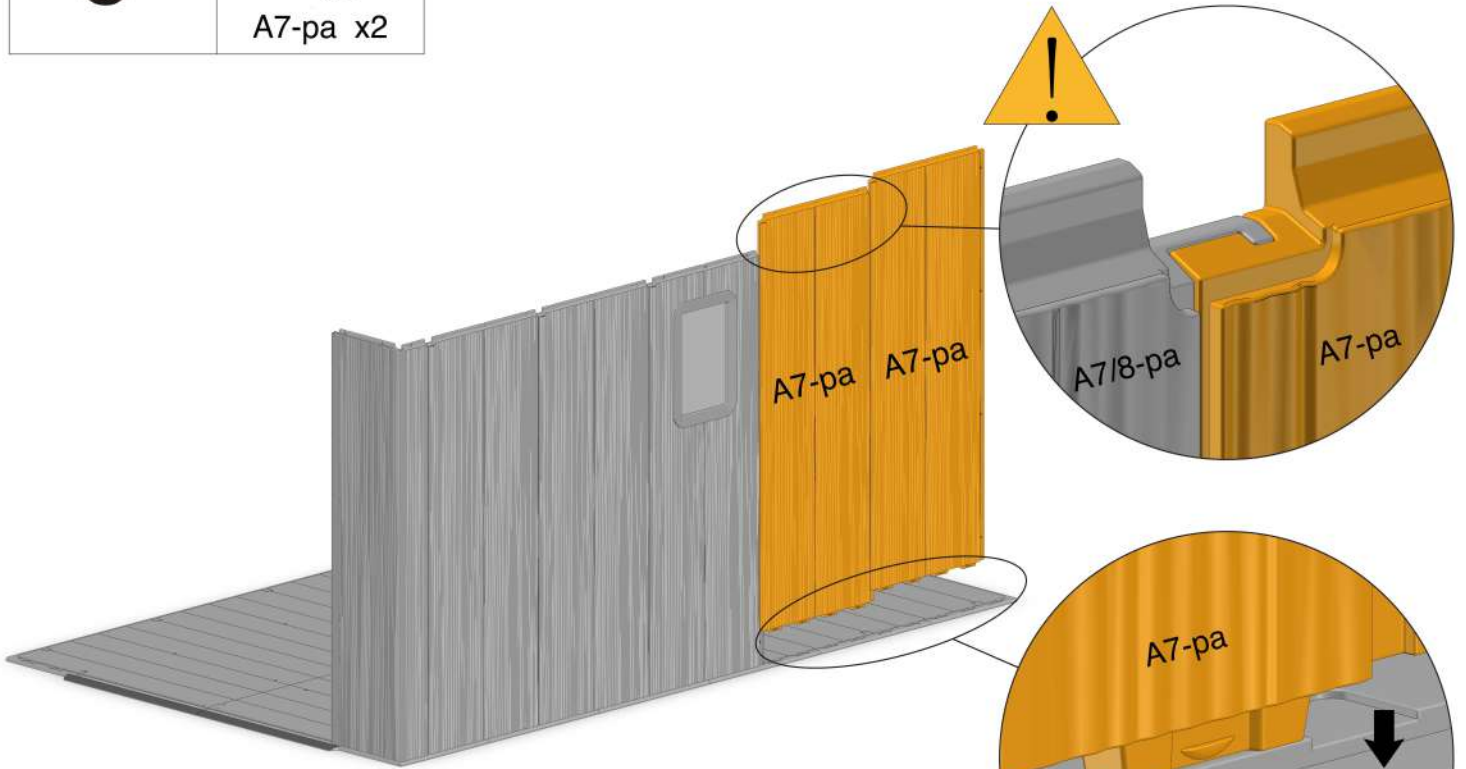

10



A9-pa x1

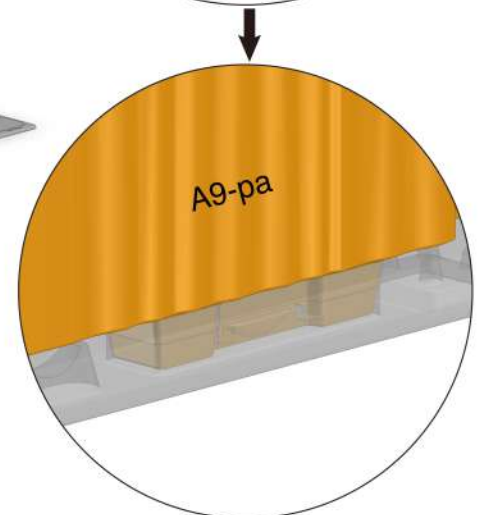
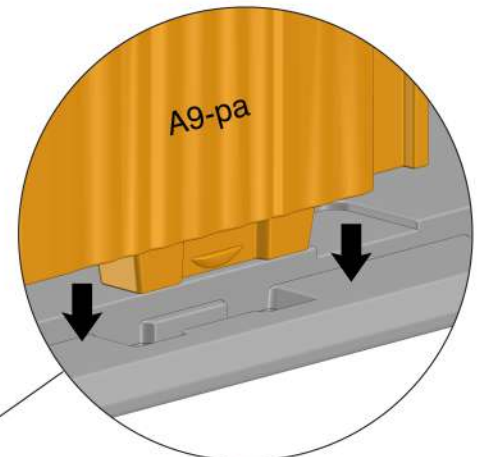
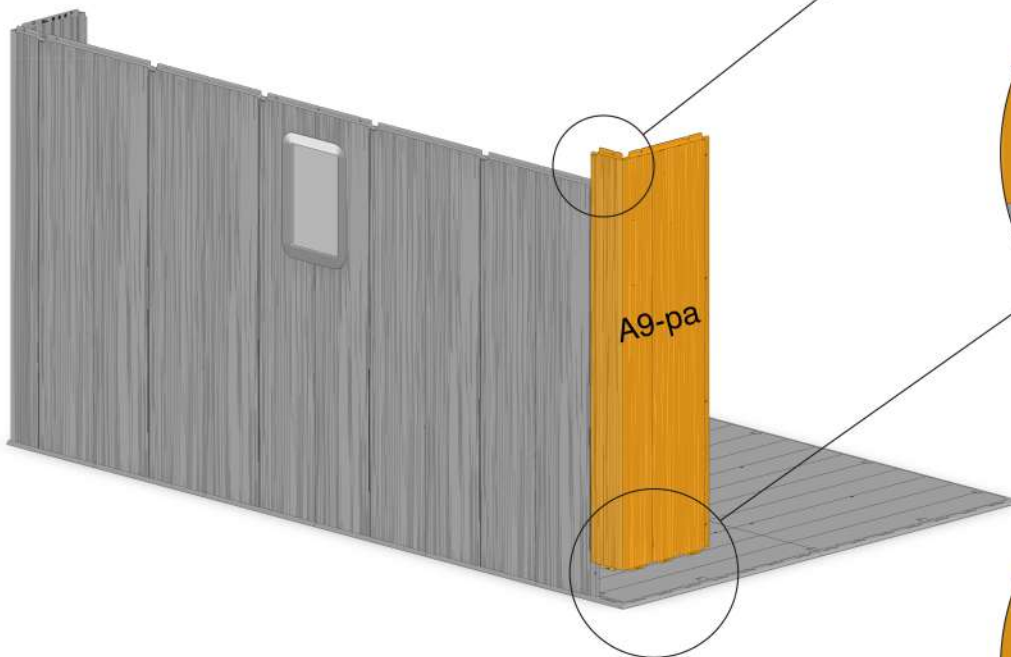
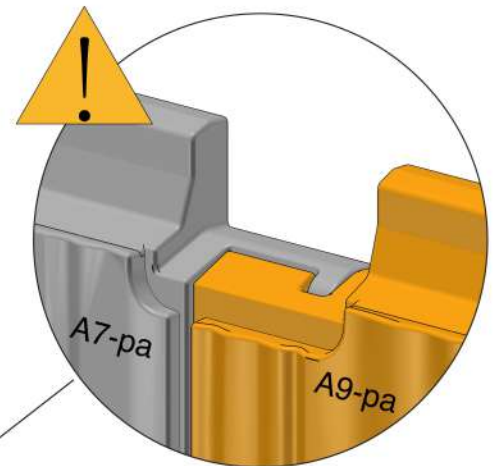
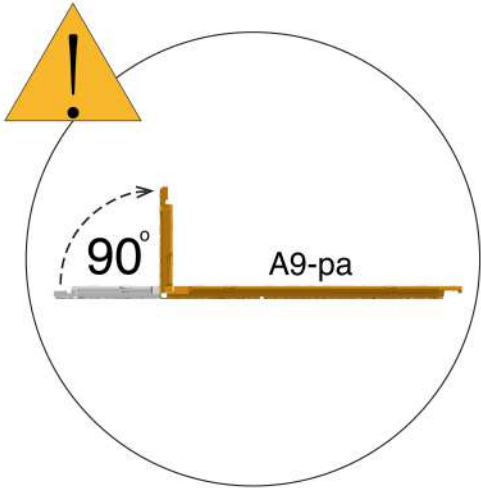
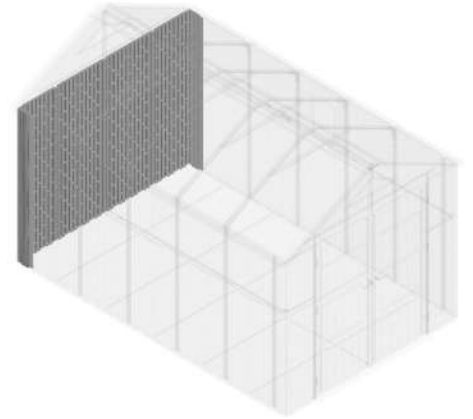

11



A7-pa x2



A10-pa x1

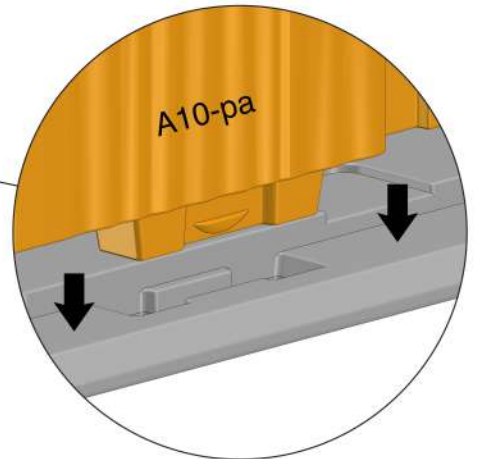
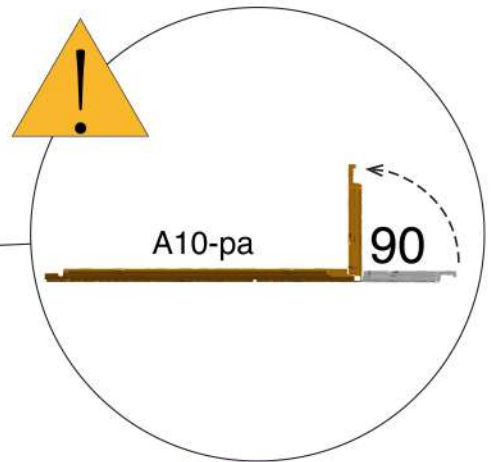
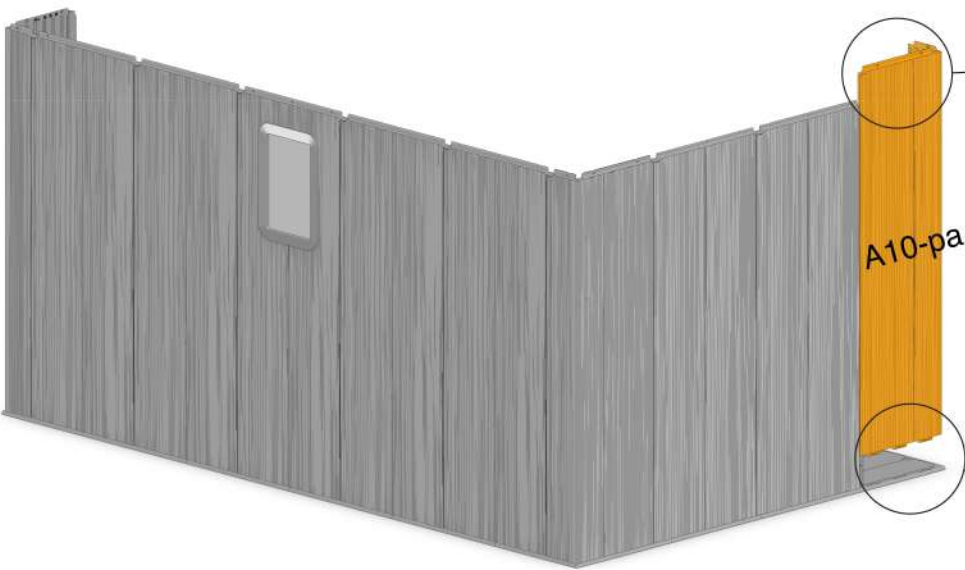
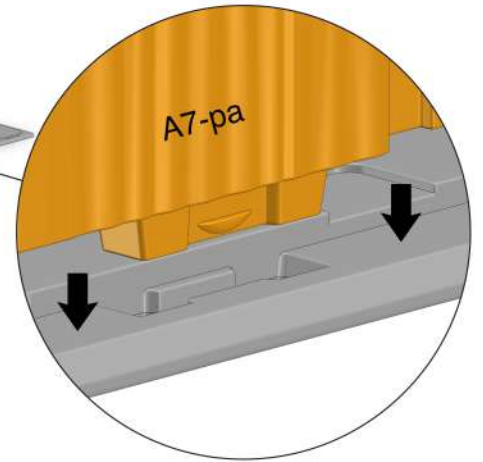
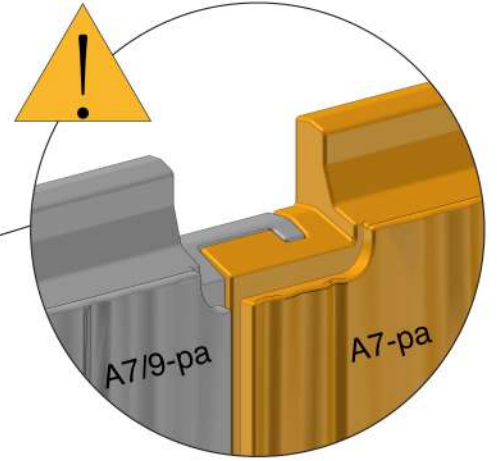
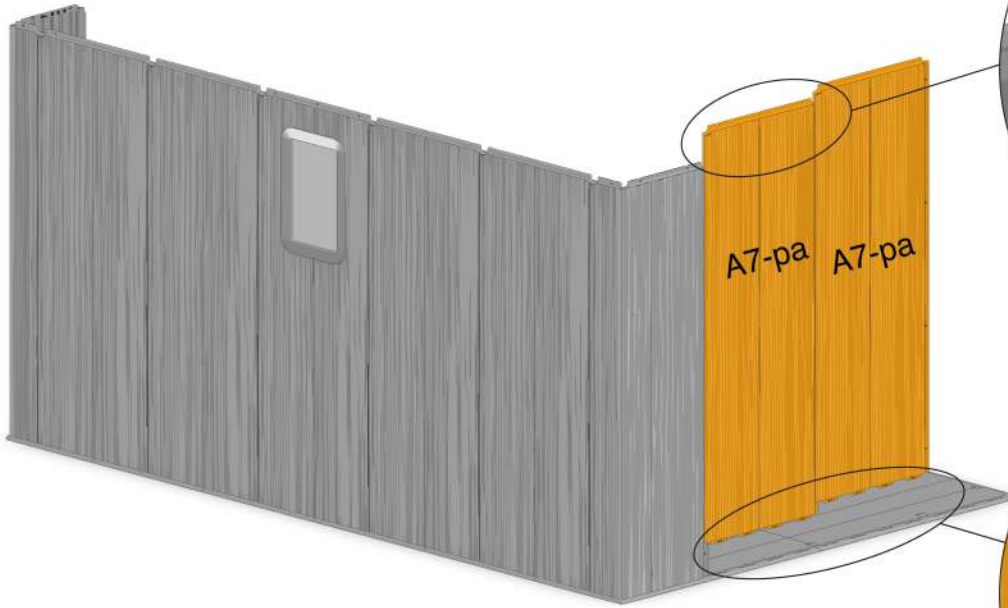

12



A7-pa x5



A11-pa x1

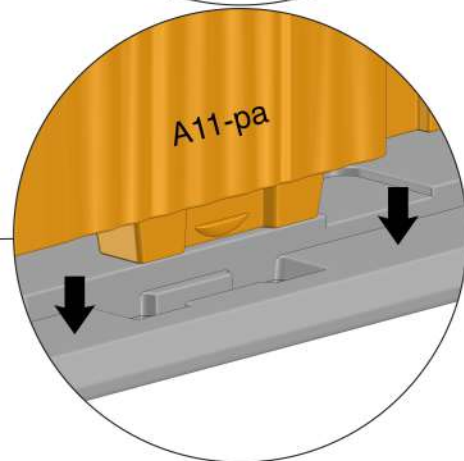
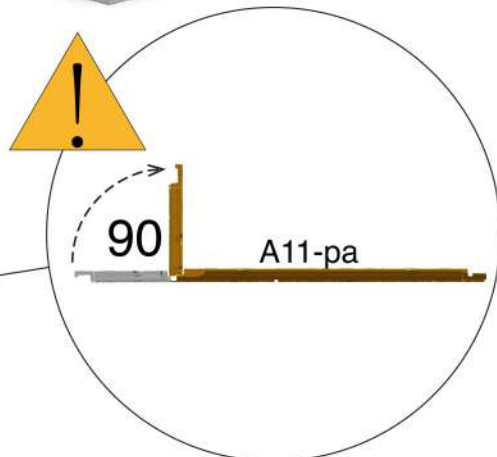
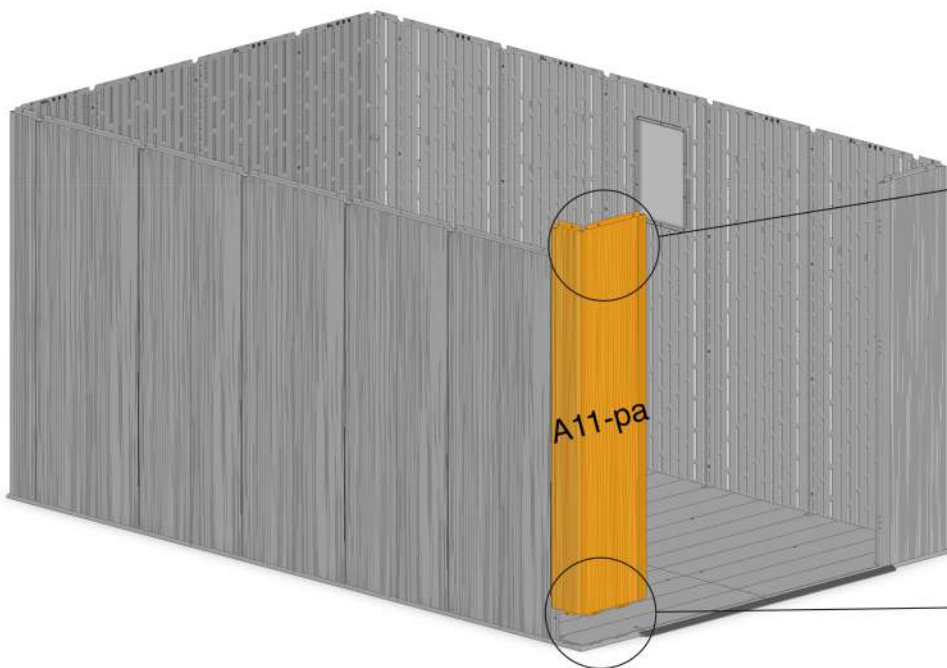
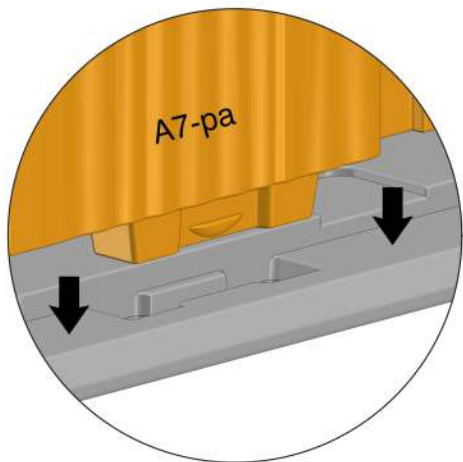
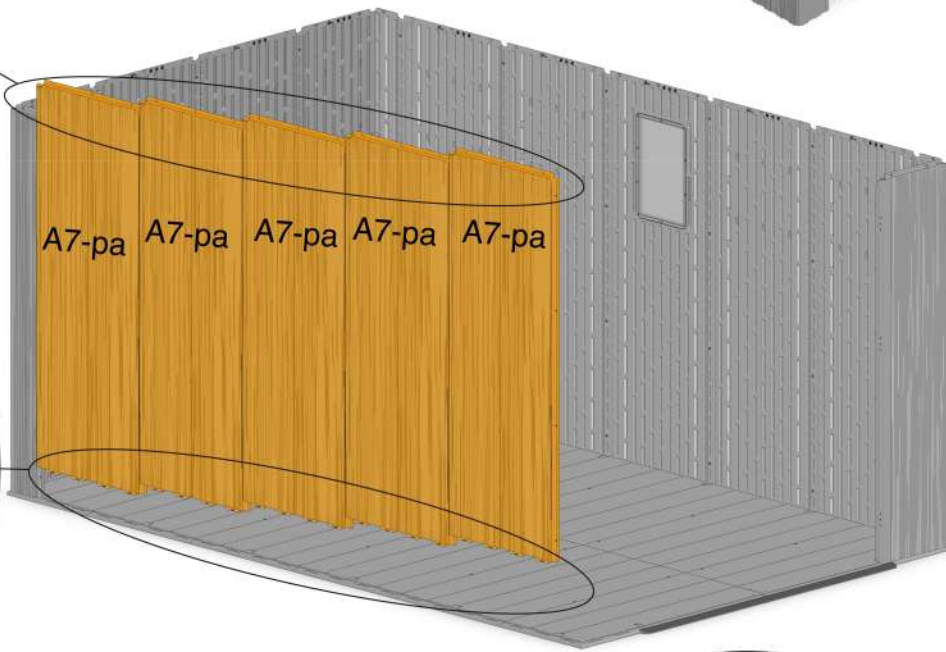
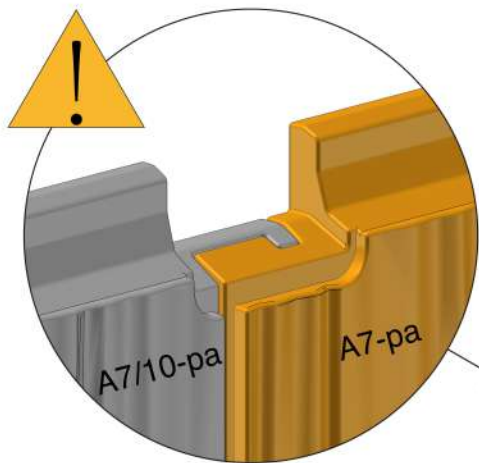

13



A30-pa x9



D54-pa x27

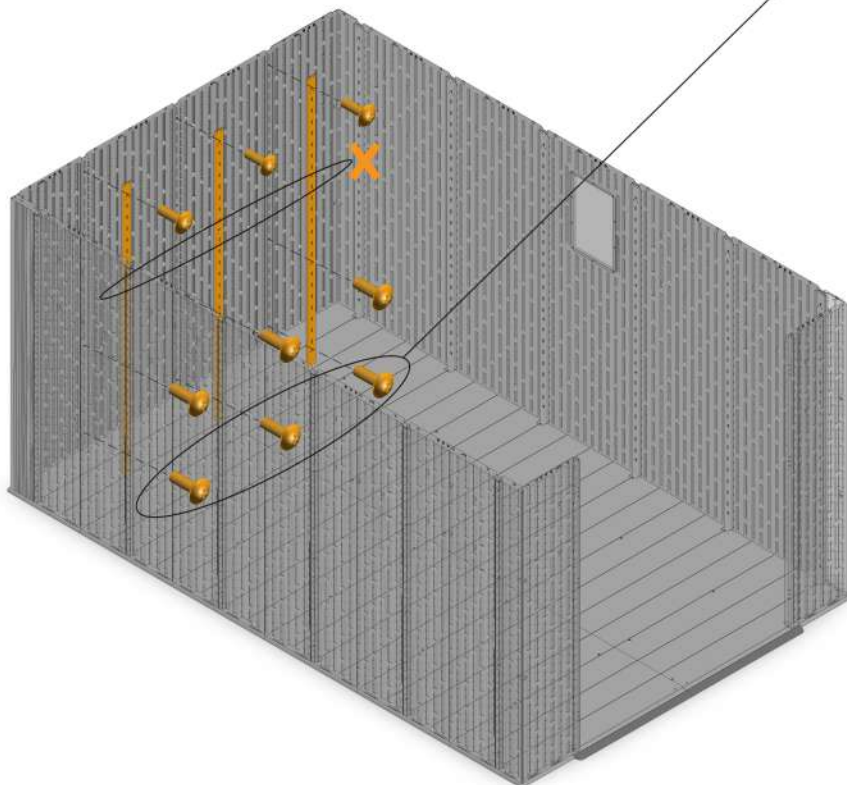
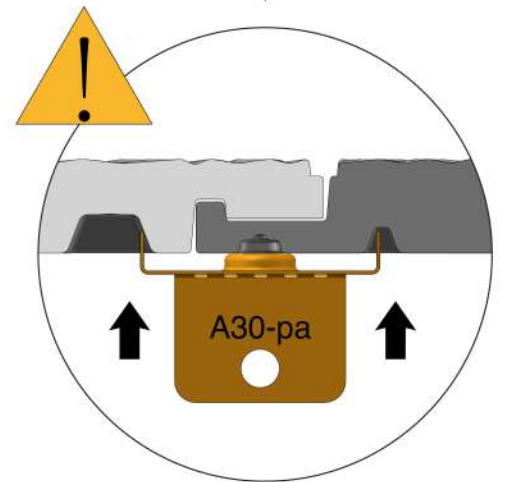
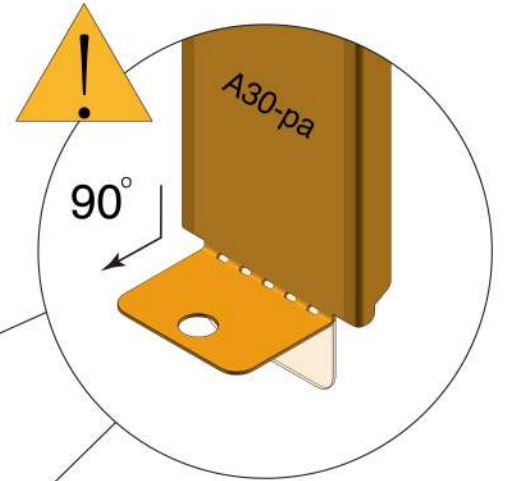
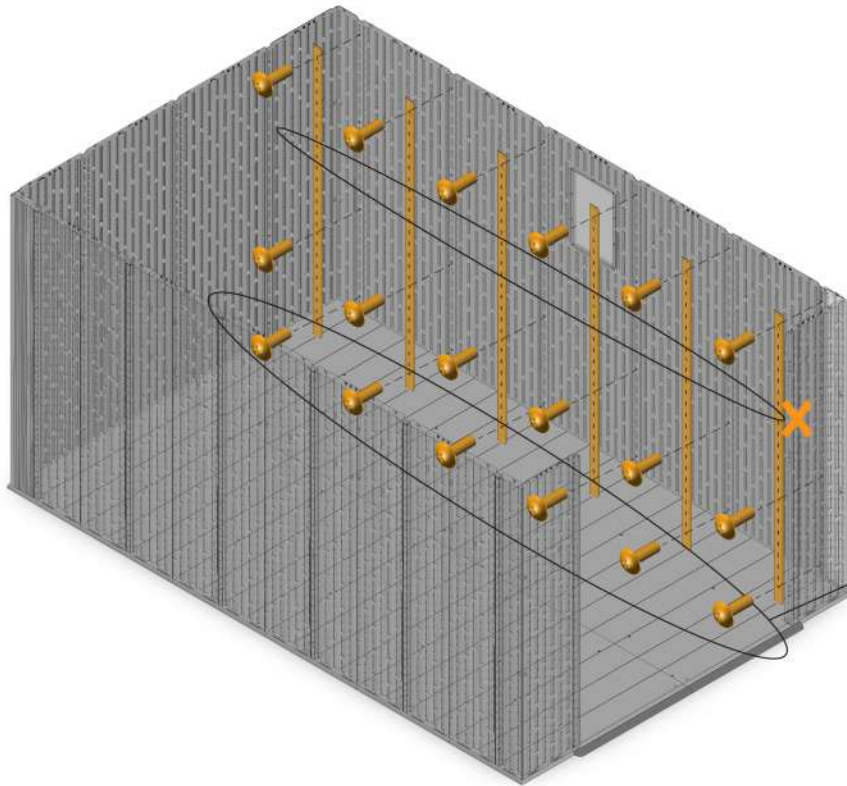

14



A30-pa x6



D54-pa x18

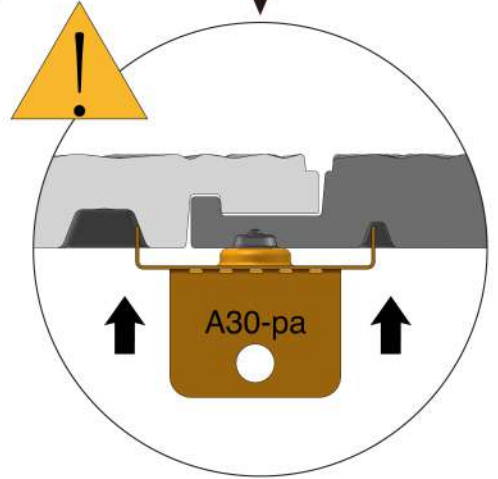
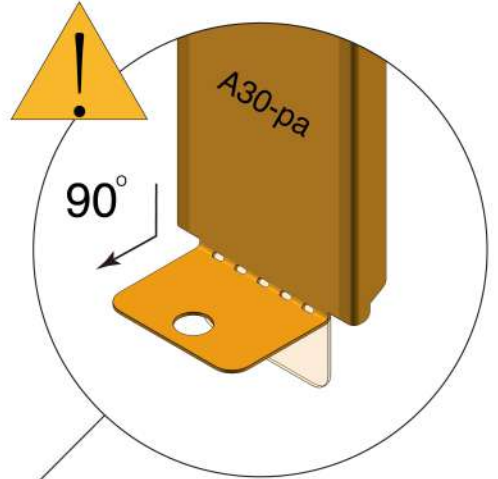
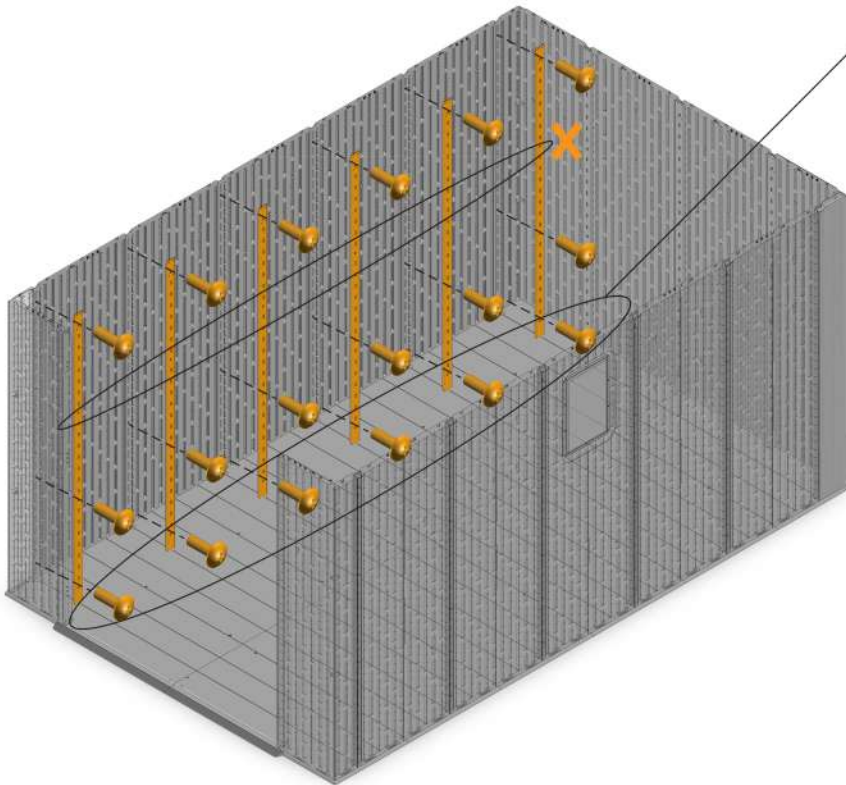

15

A46-pa x1

C47a-pa x2

D47-pa x2

D55-pa x15

D51-pa x8

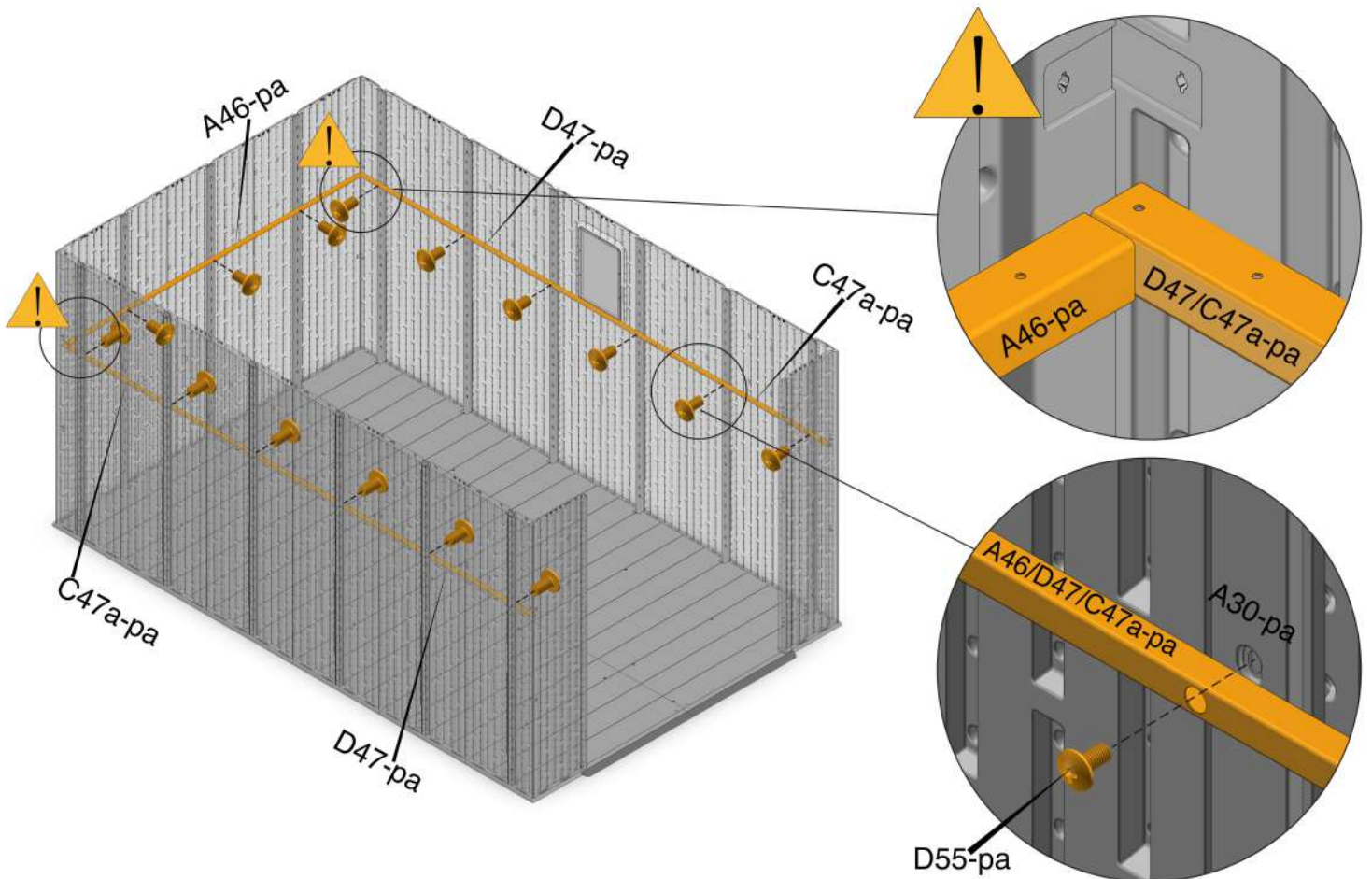
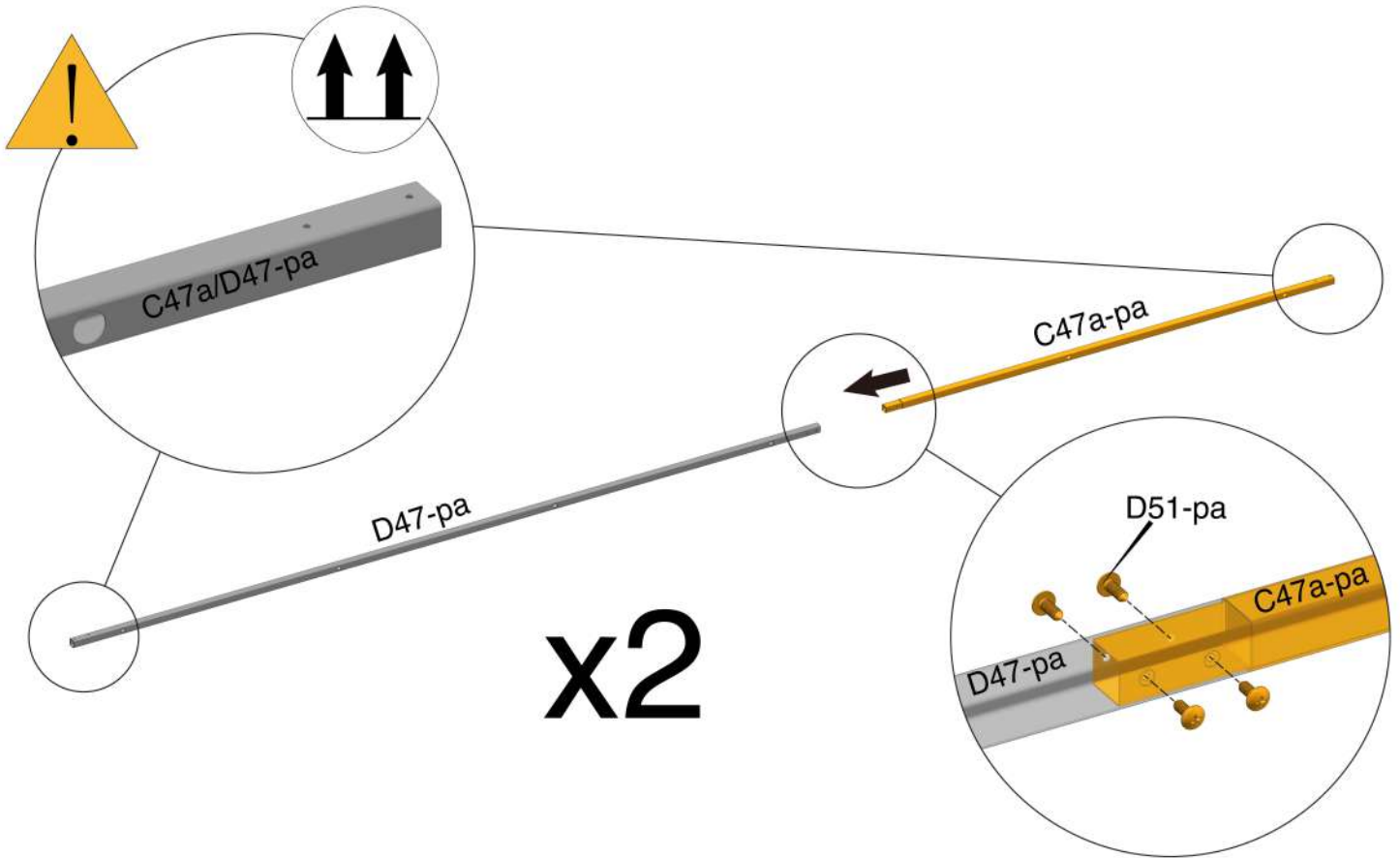

16



Ab-4 x4



D51-pa x10

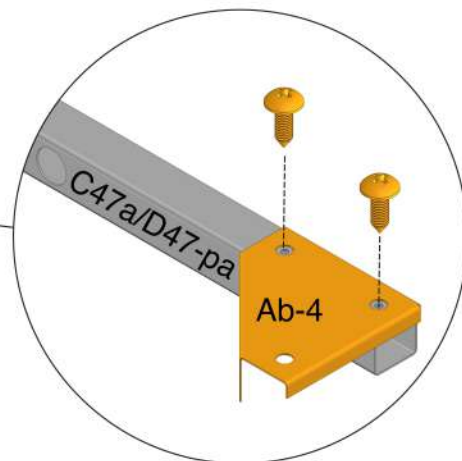
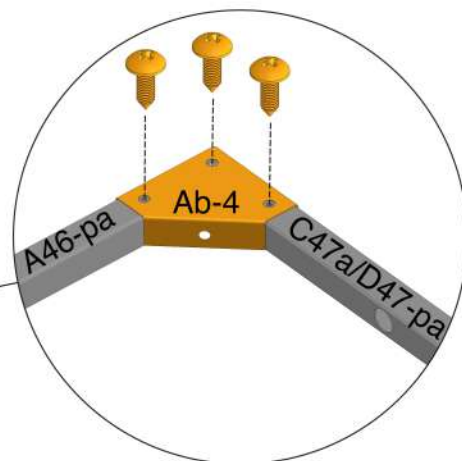
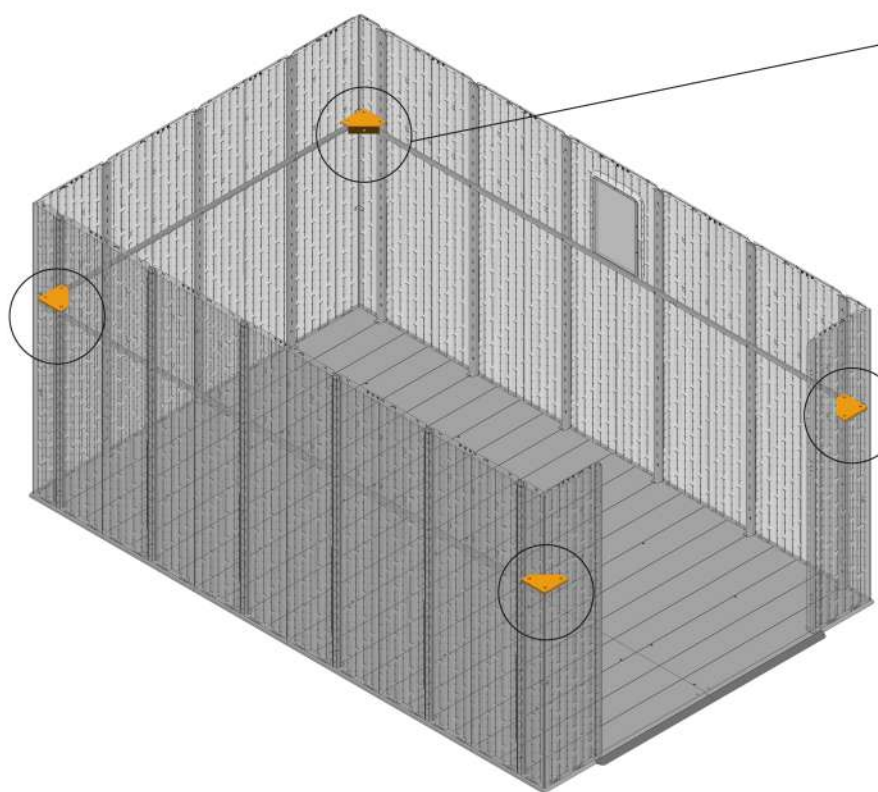

17

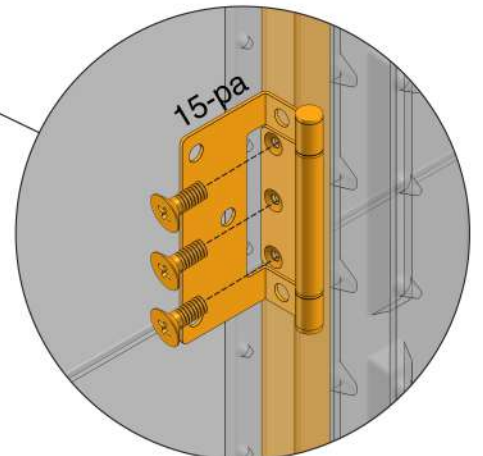
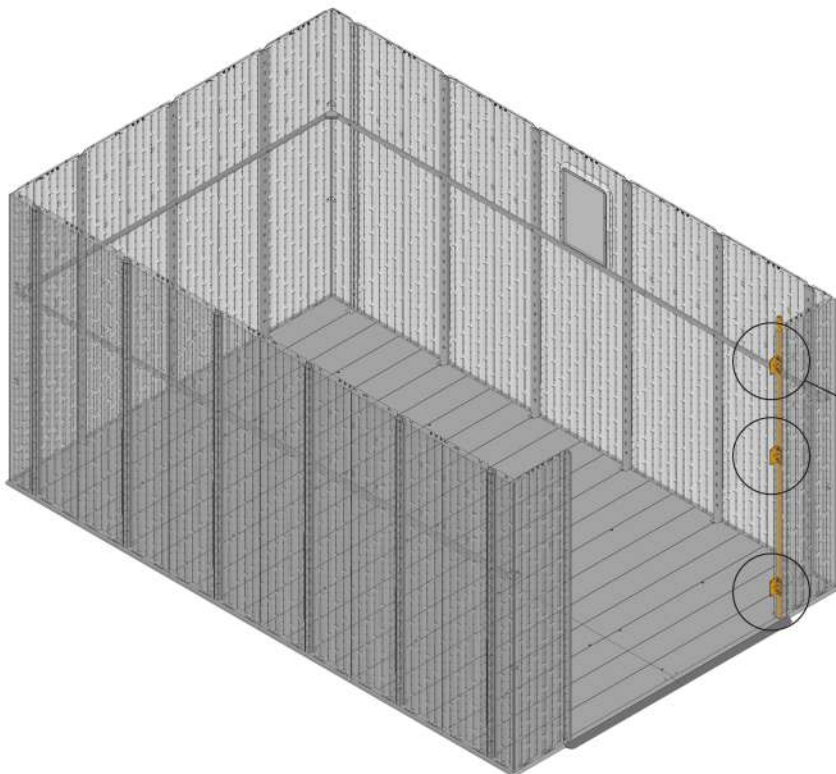
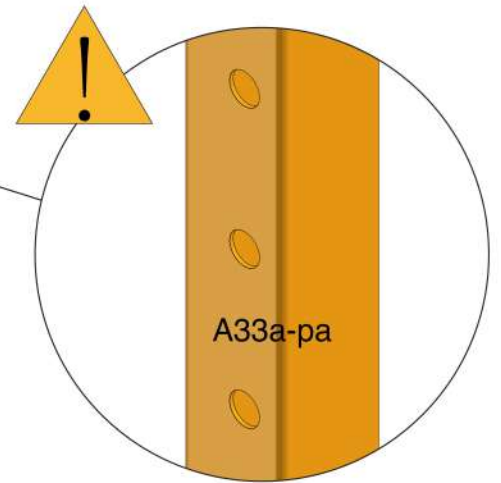
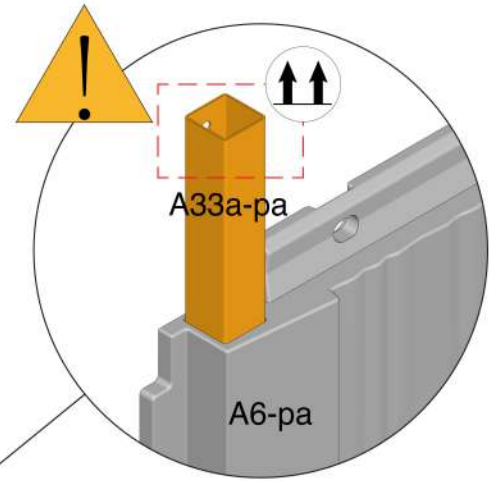
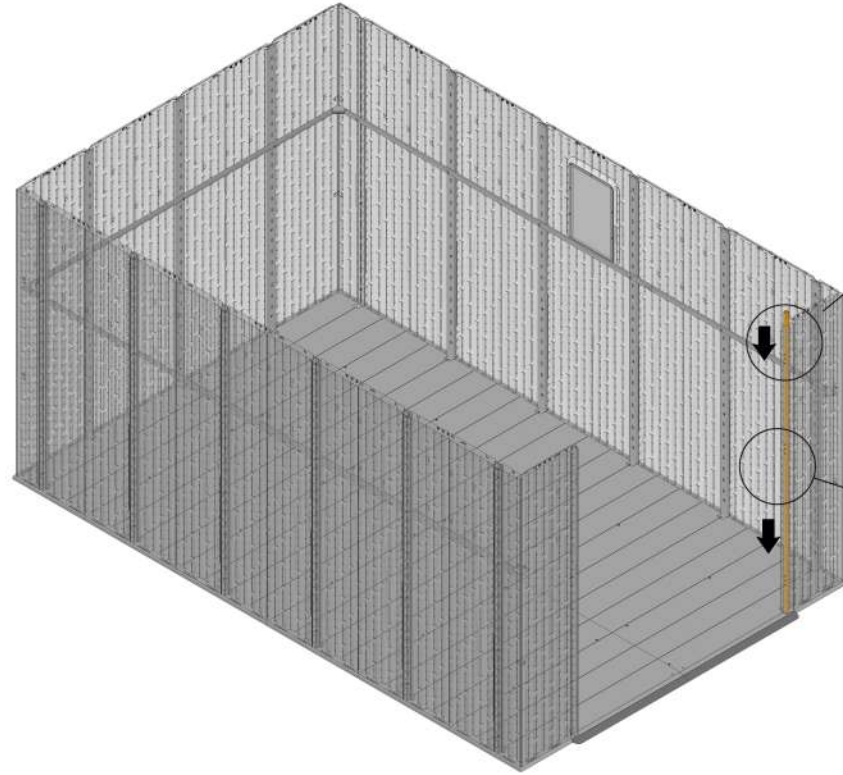
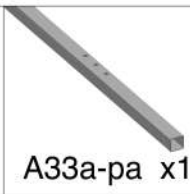

18

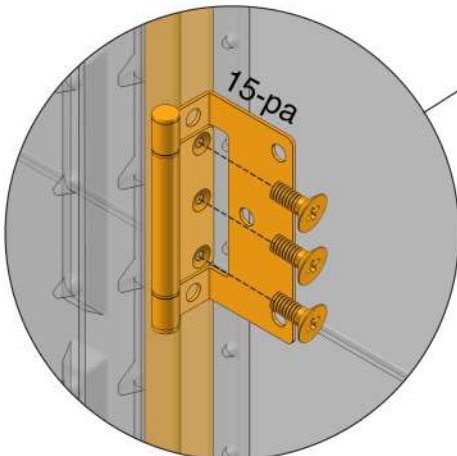
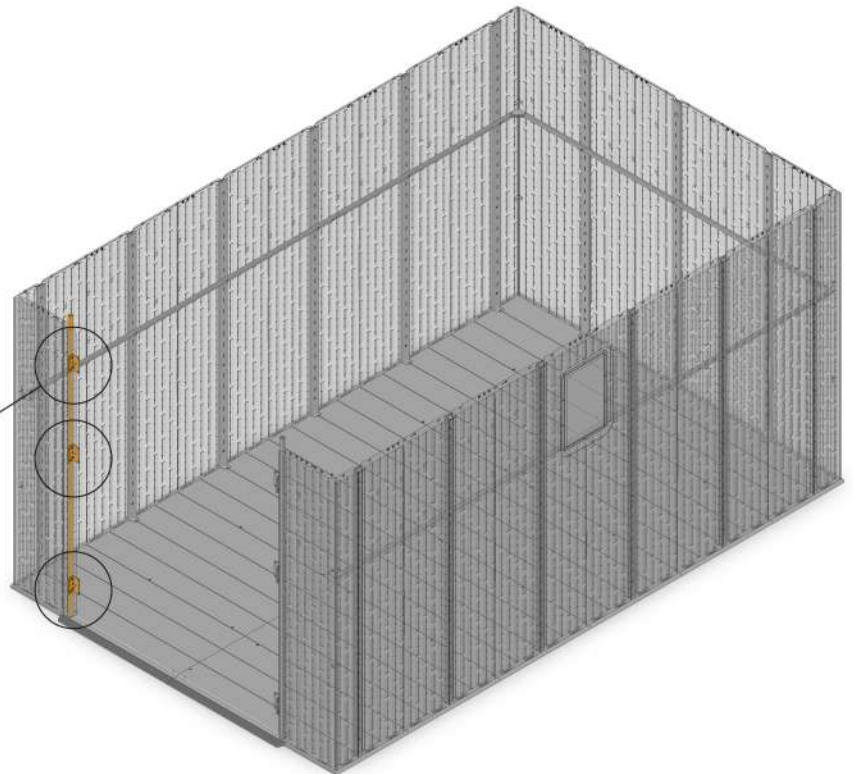
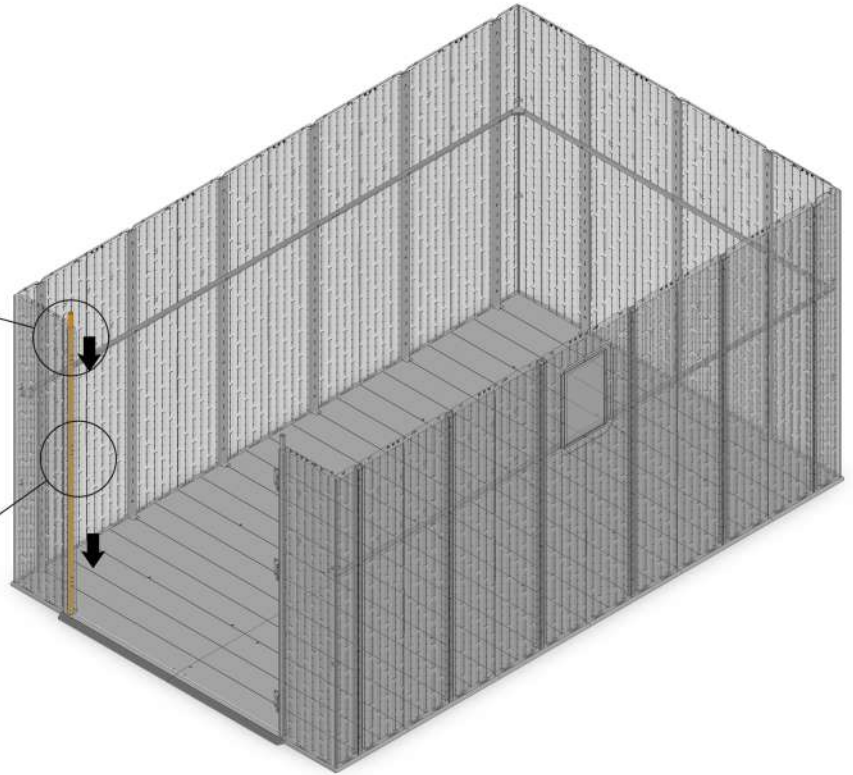
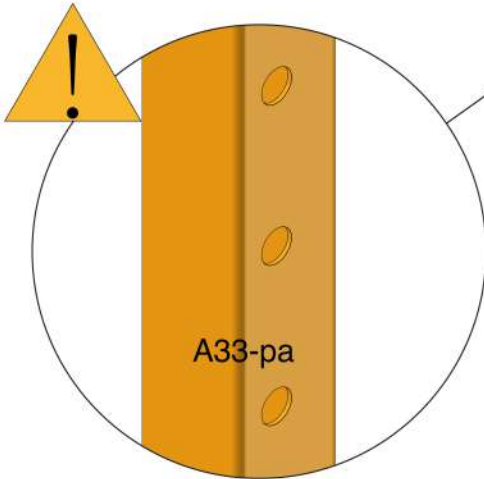
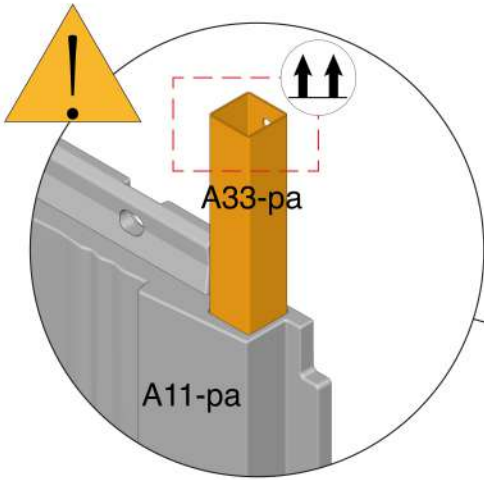

19



A48-pa x2



21-pa x2



16-pa x10



D51-pa x2



D52-pa x4



D58-pa x16

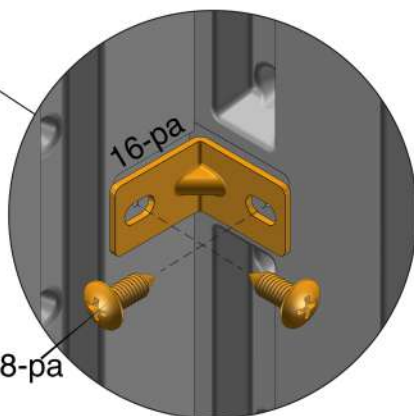
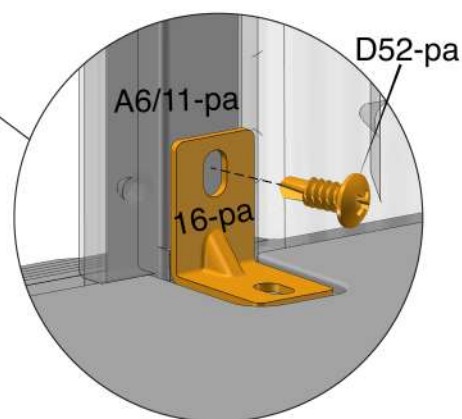
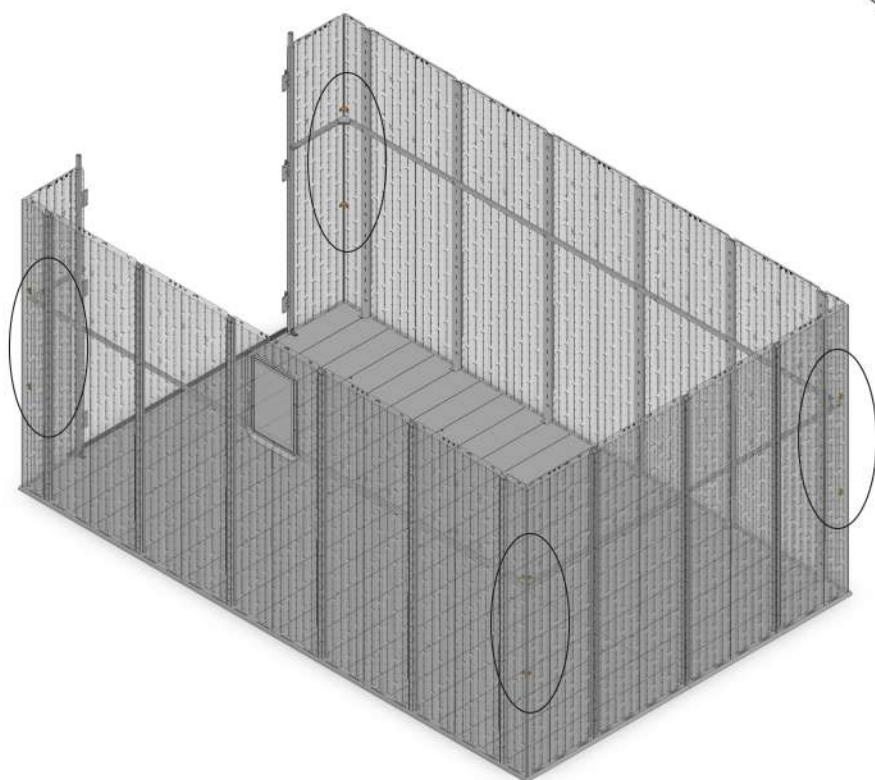
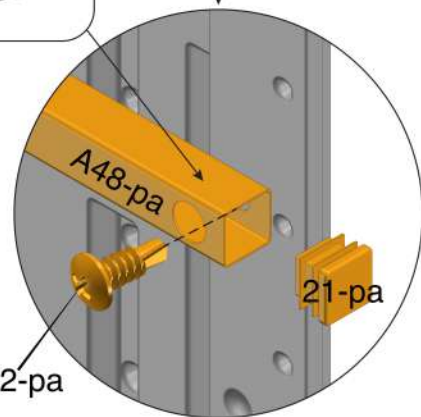
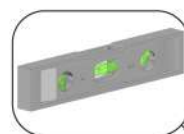
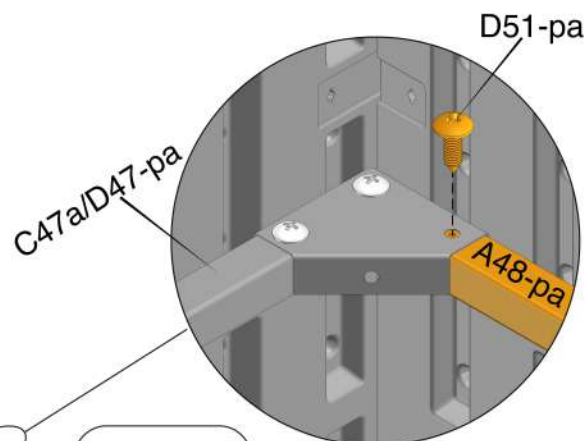
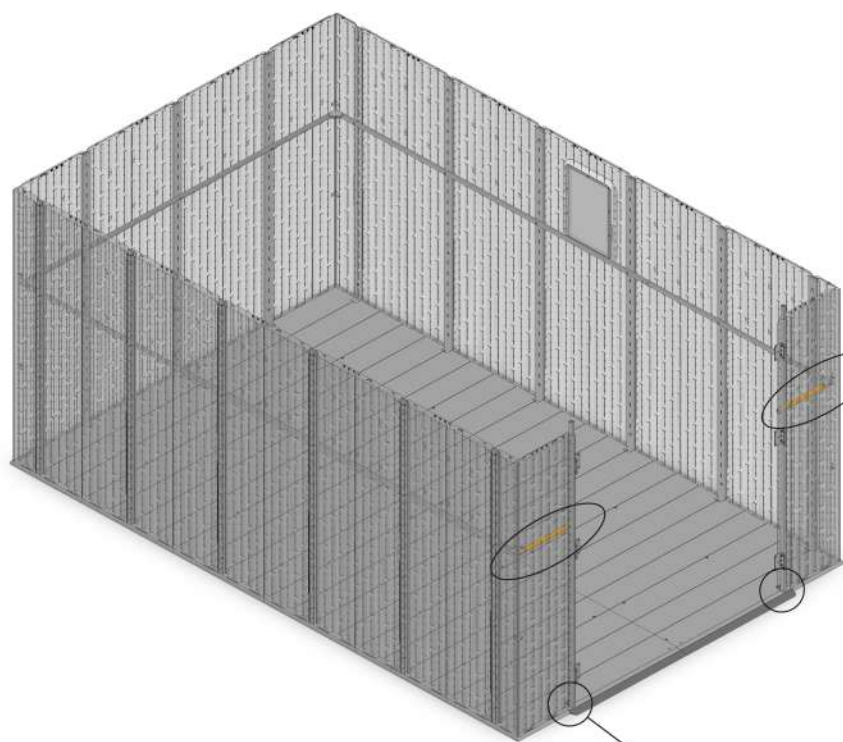

20



A43-pa x8



D58-pa x32

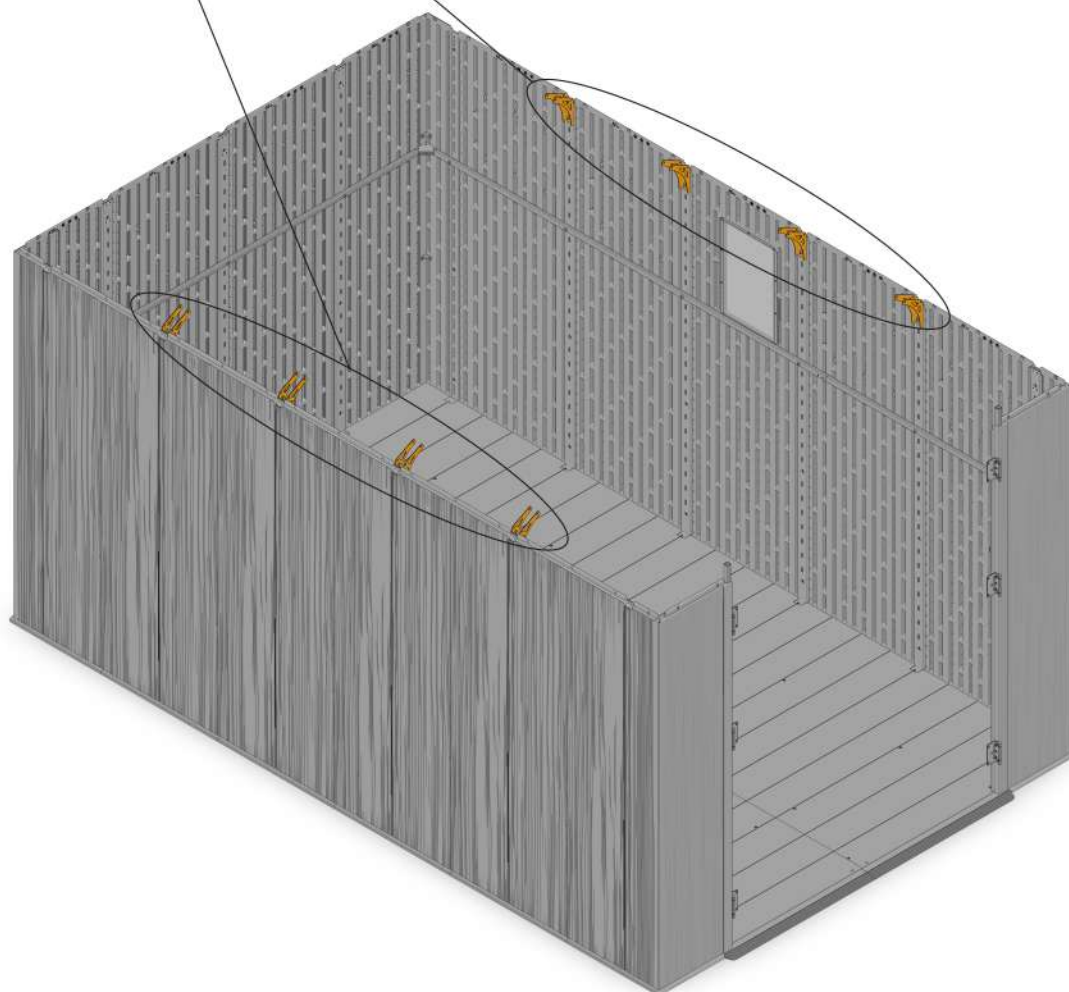
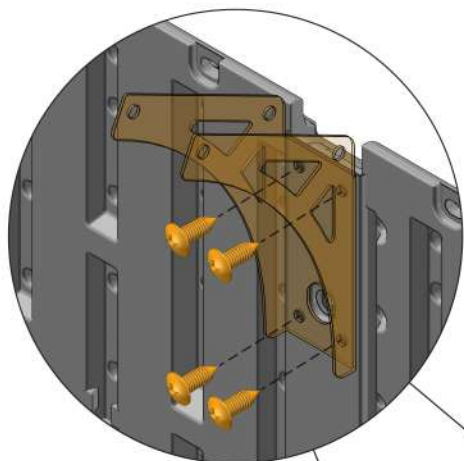
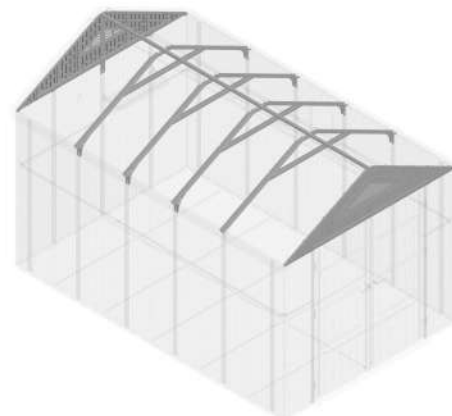

21

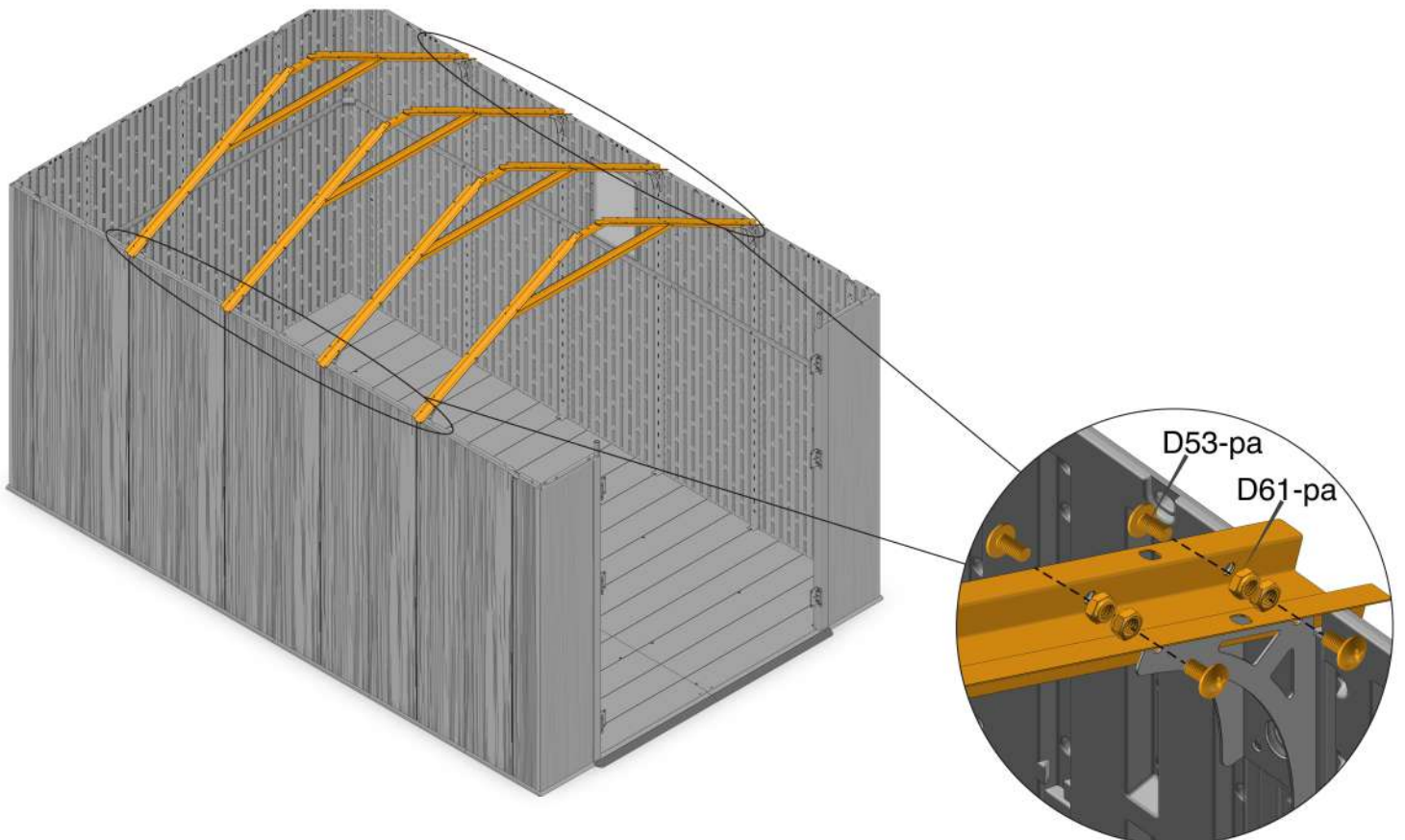
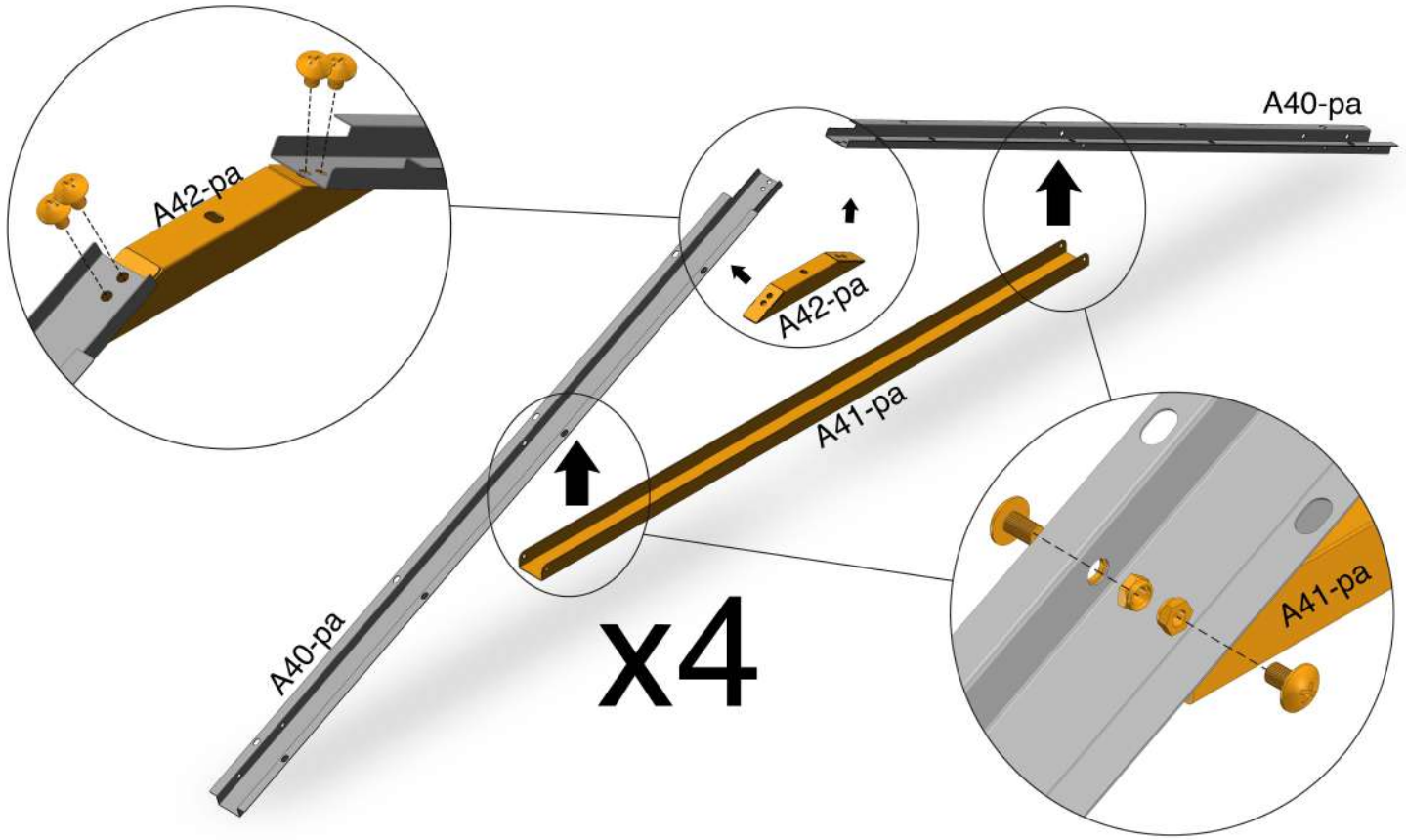
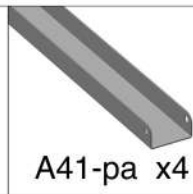
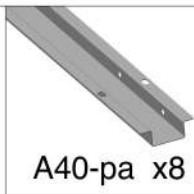

22



A12-pa x1



A13-pa x1



A24-pa x1



D54-pa x3



D51-pa x6

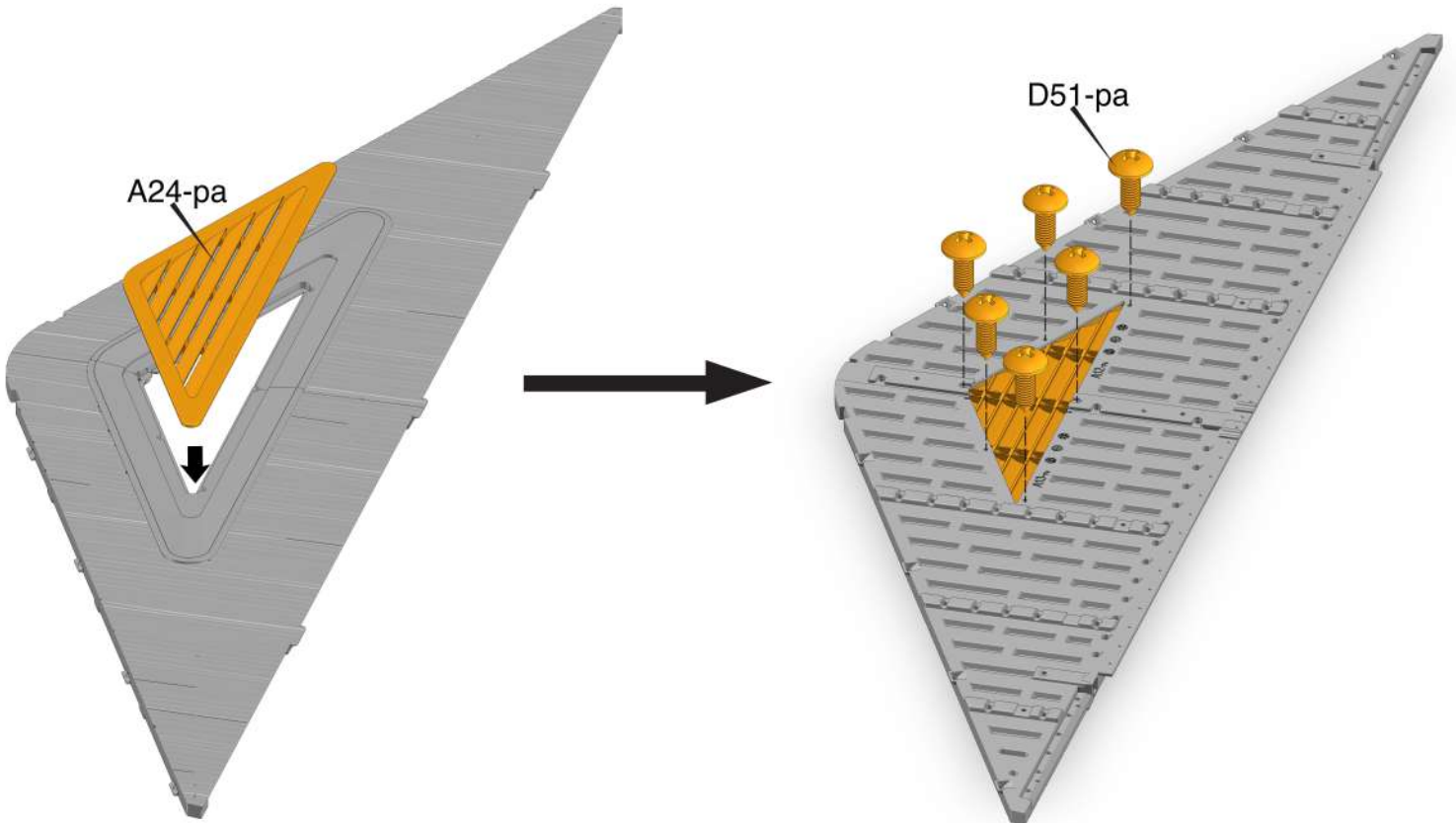
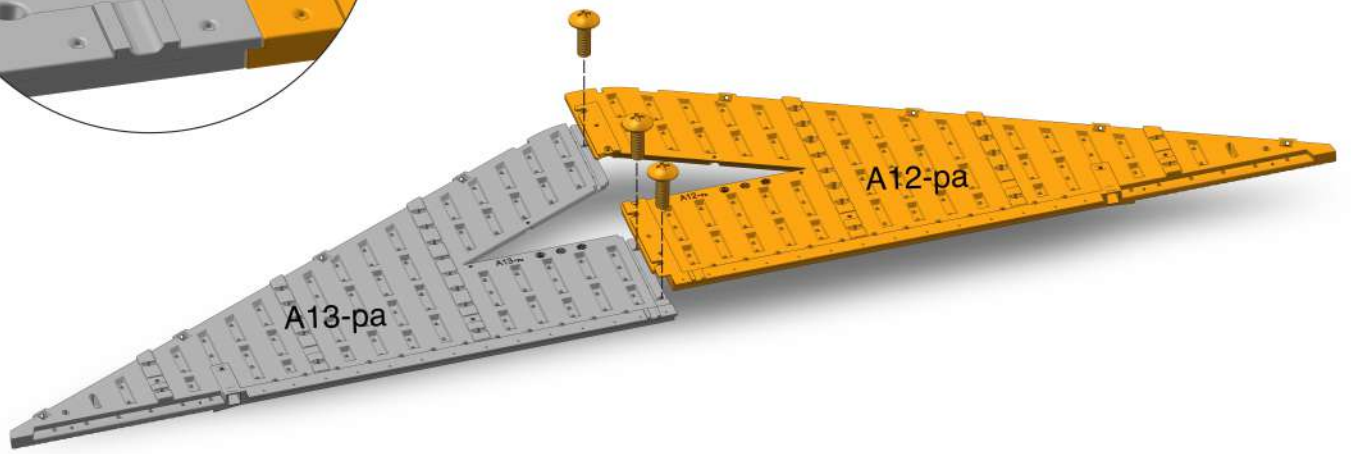
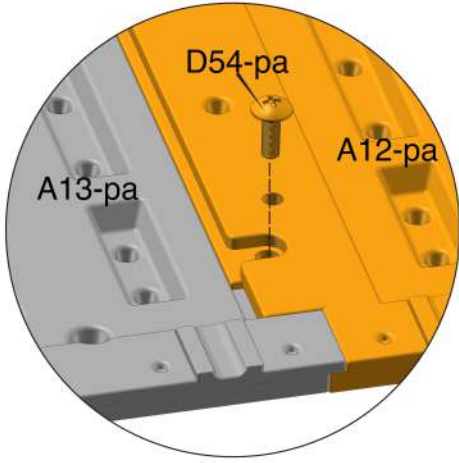

23

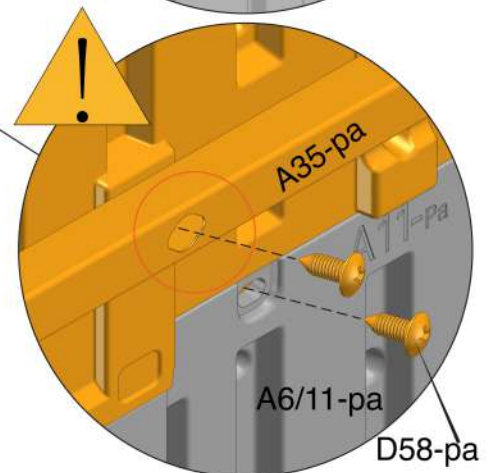
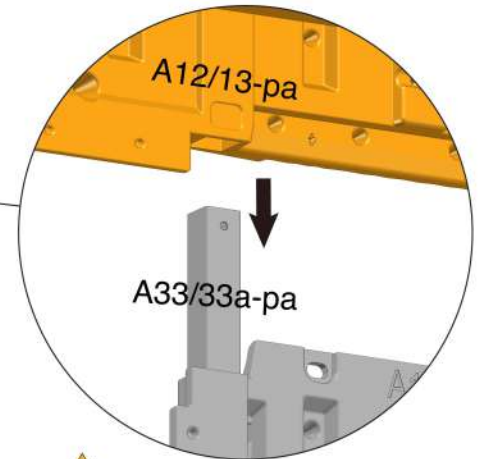
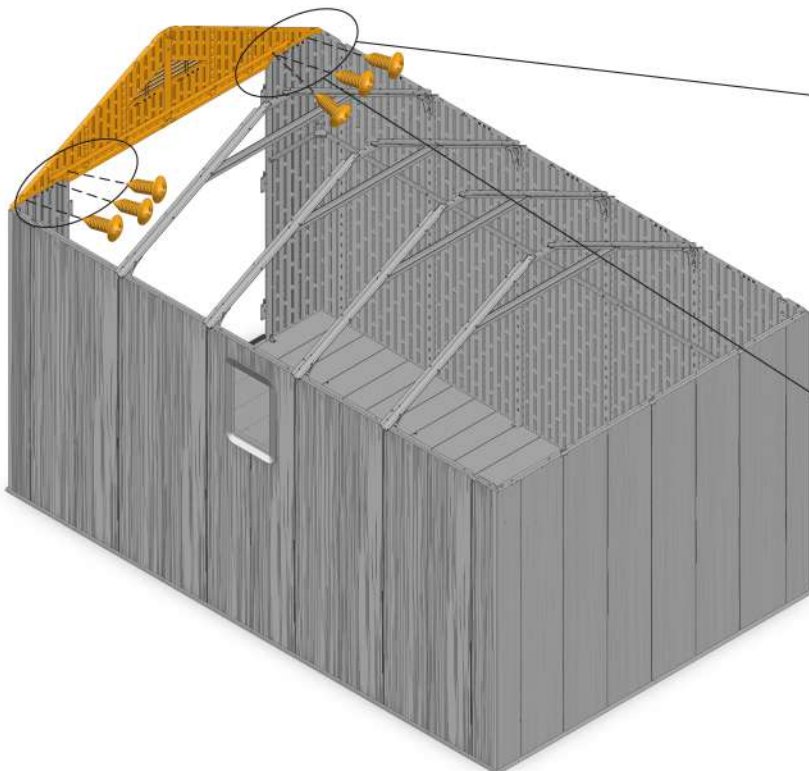
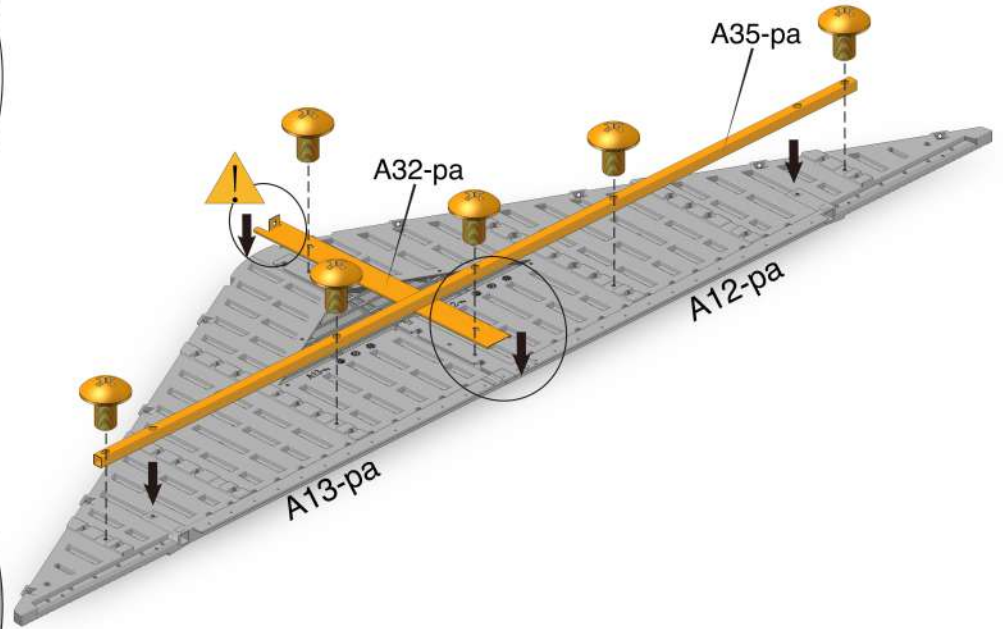
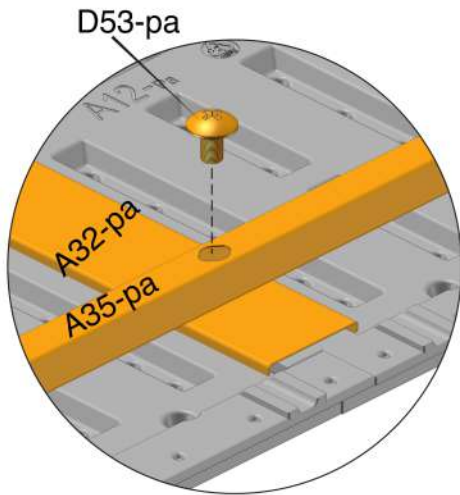
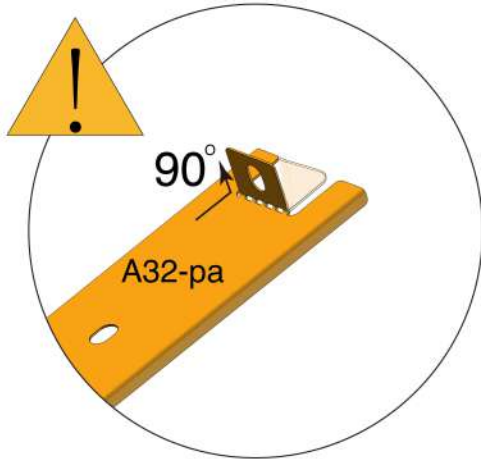

24



A14-pa x1



A15-pa x1



A24-pa x1



D54-pa x3



D51-pa x6

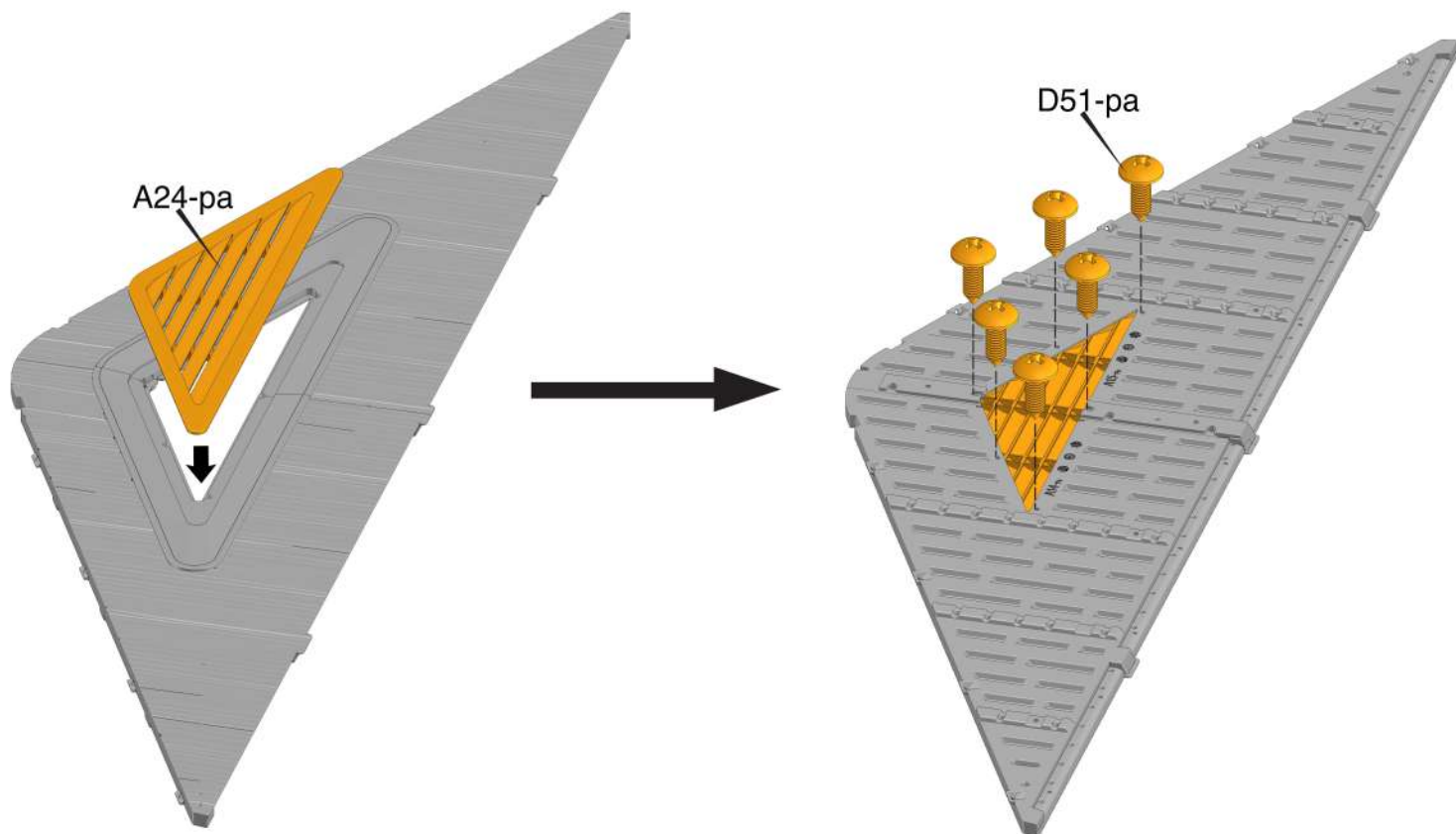
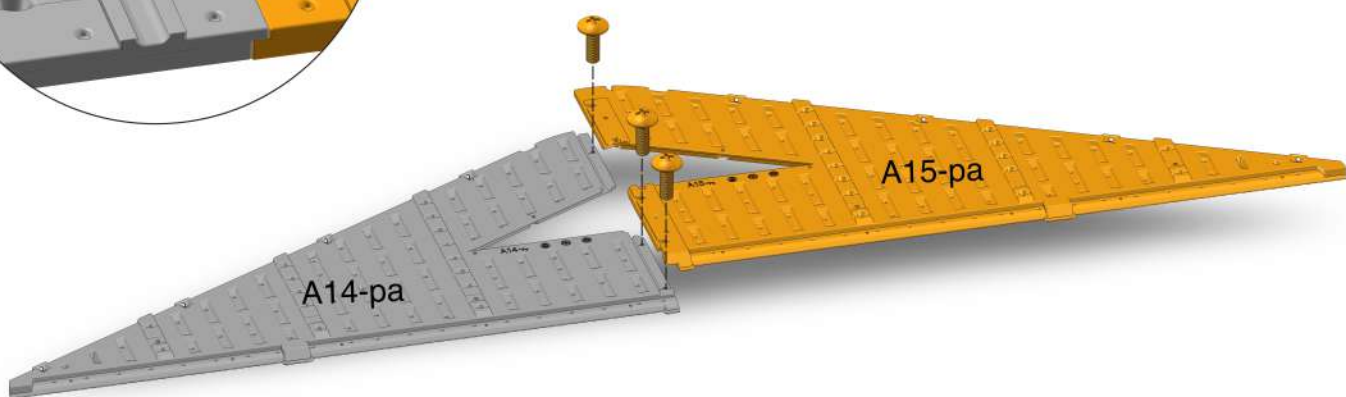
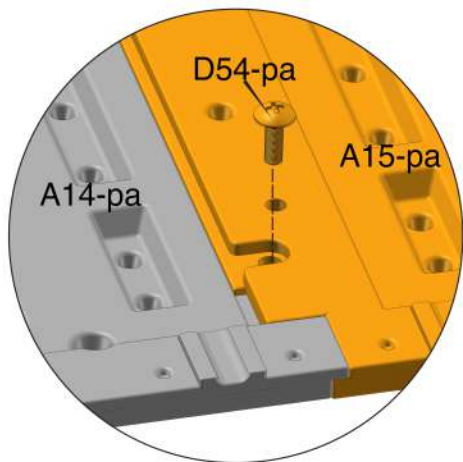

25

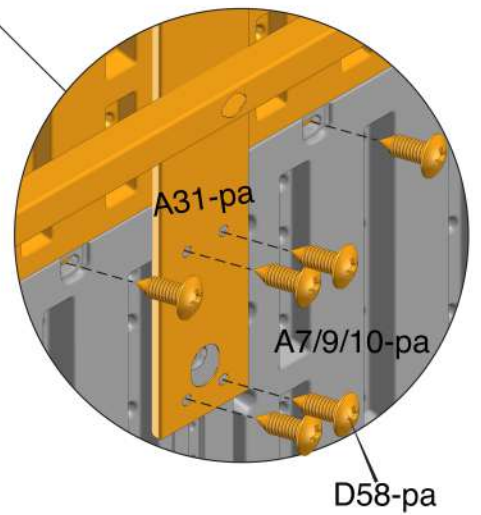
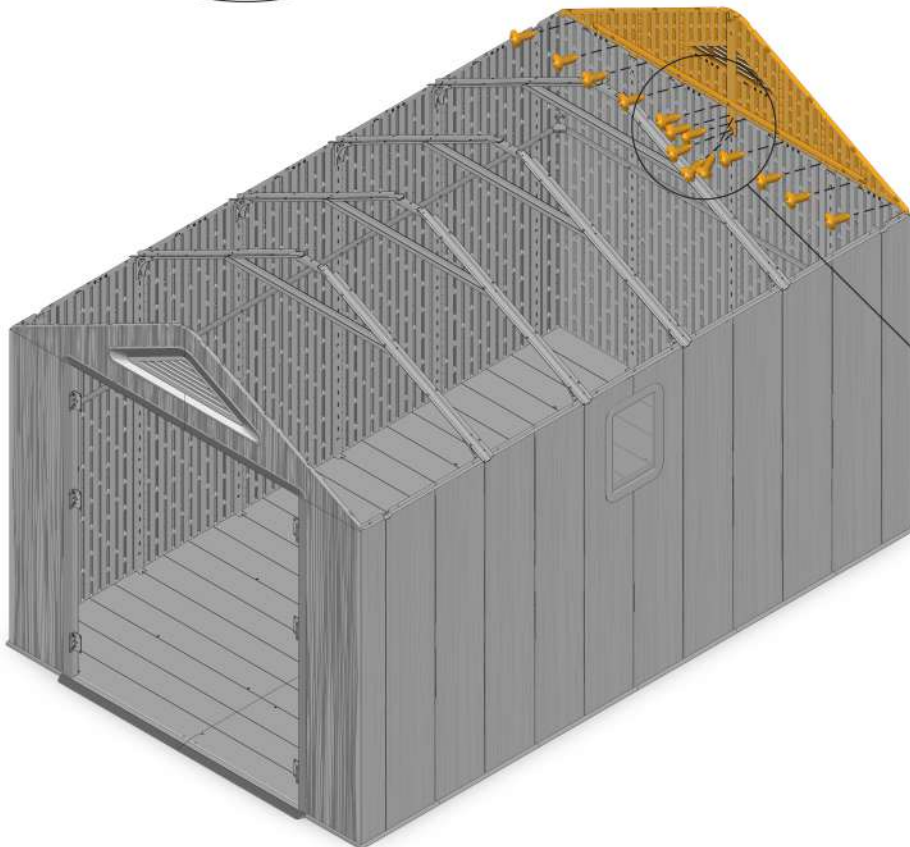
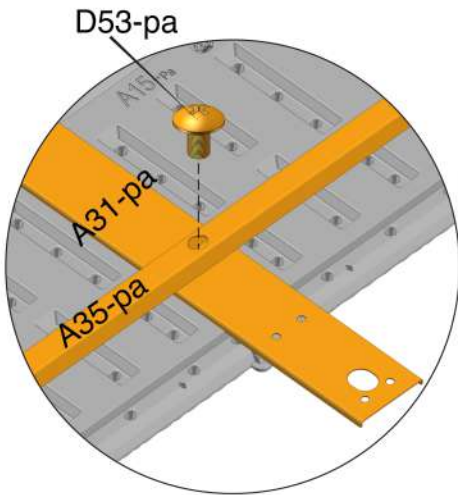
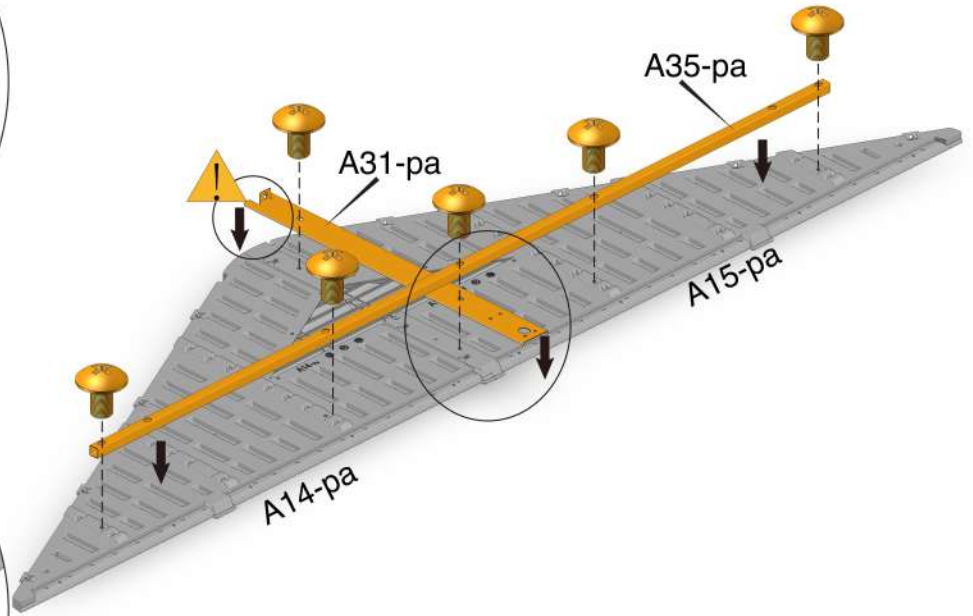
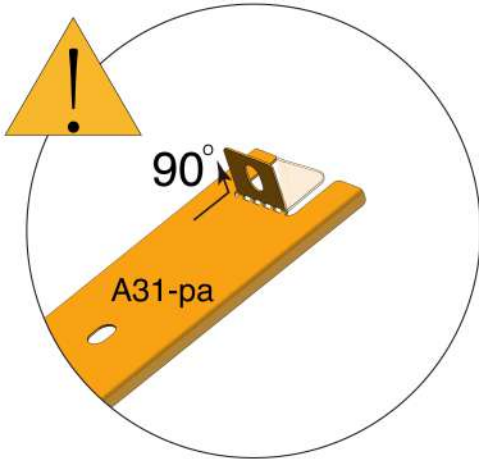

26

B37-pa x1

D36-pa x1

D56-pa x6

D53-pa x2

D61-pa x2

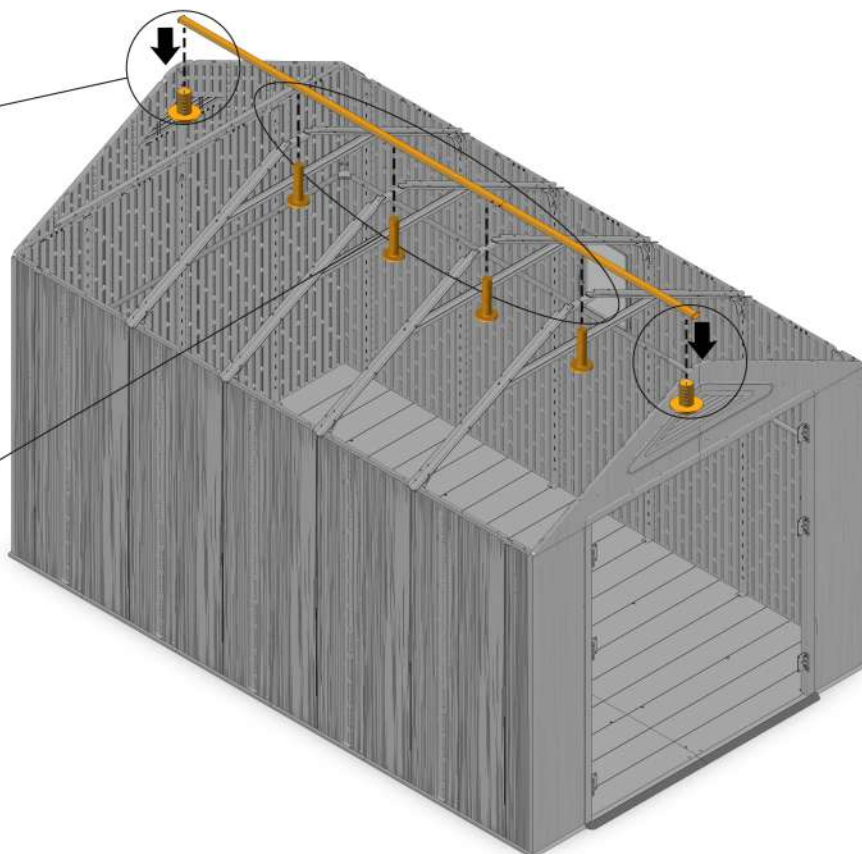
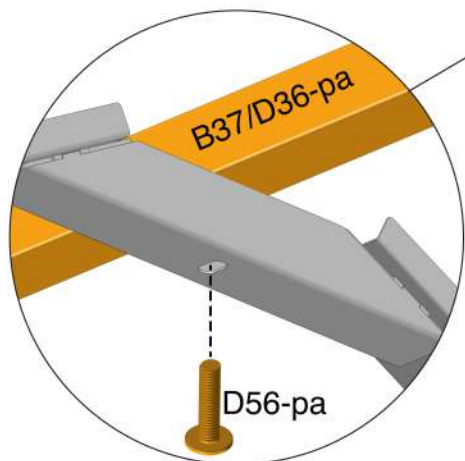
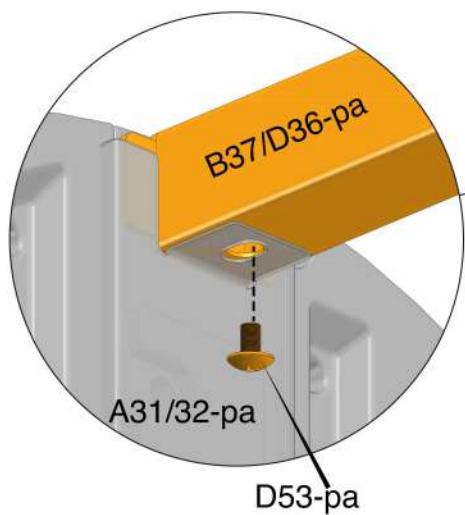
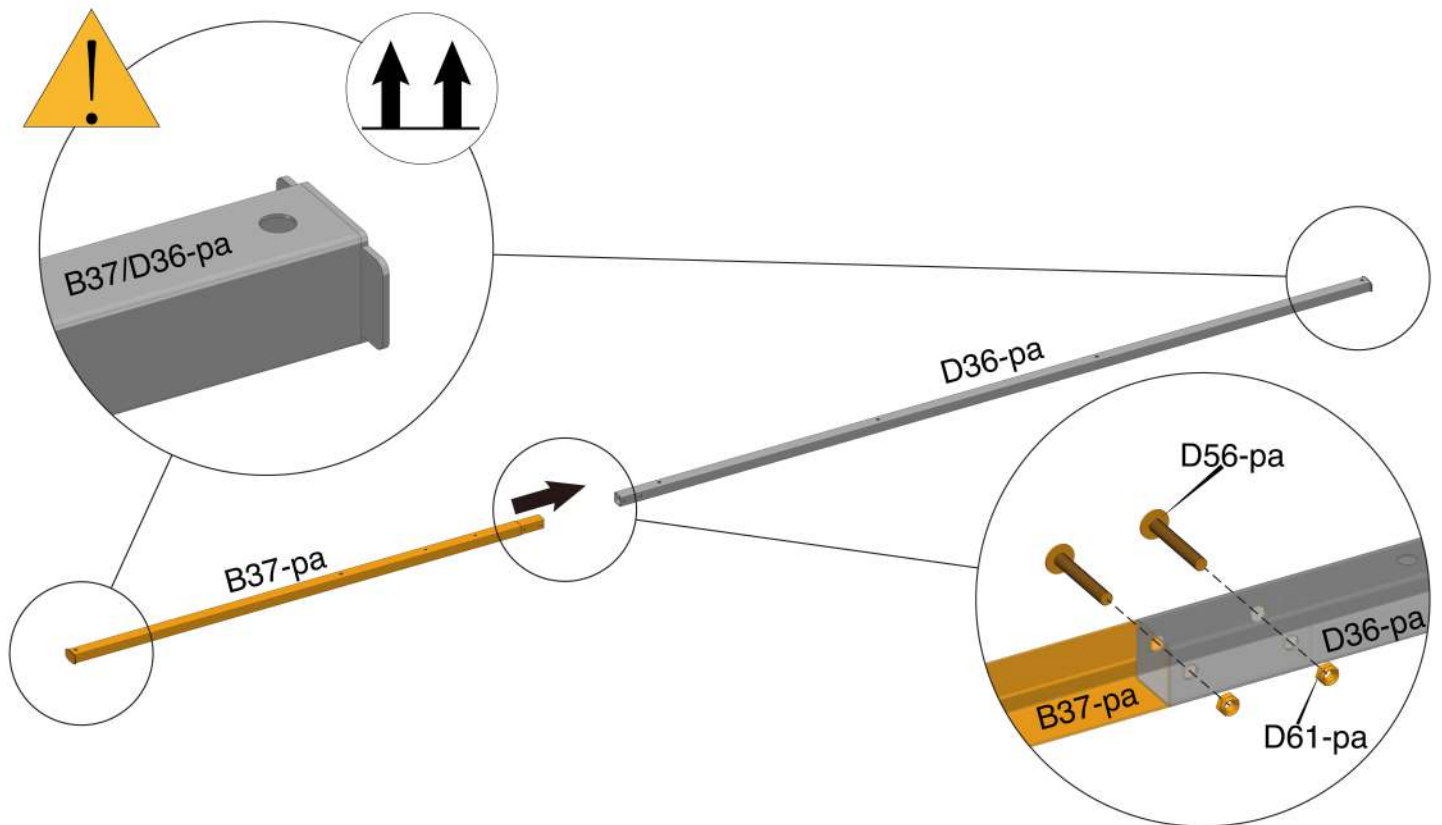

27

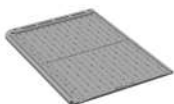

A16-pa x2

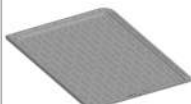

A17-pa x2

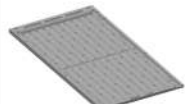

A18-pa x6



A44-pa x4



A45-pa x6



D51-pa x20

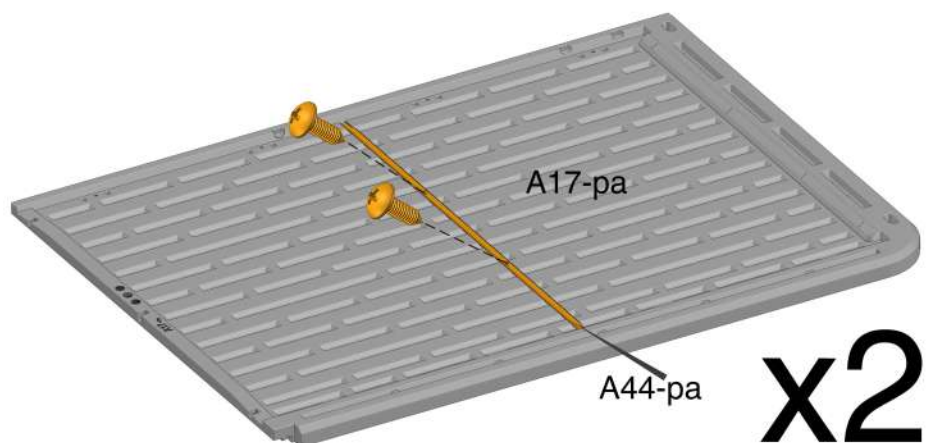
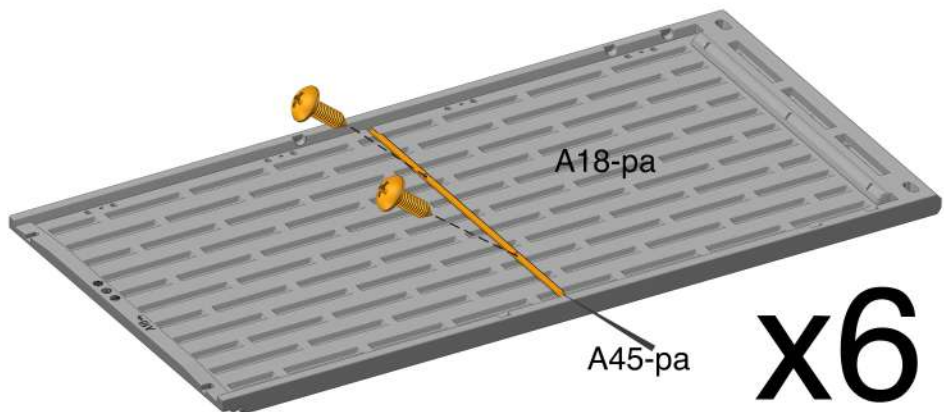
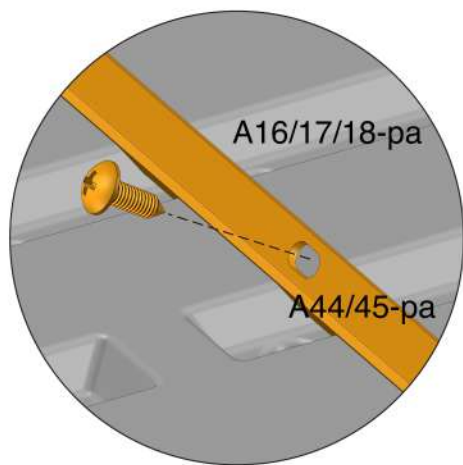
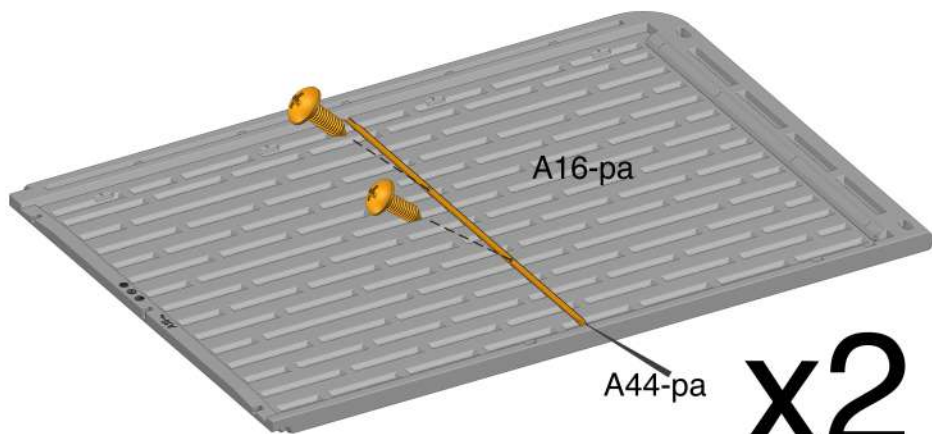
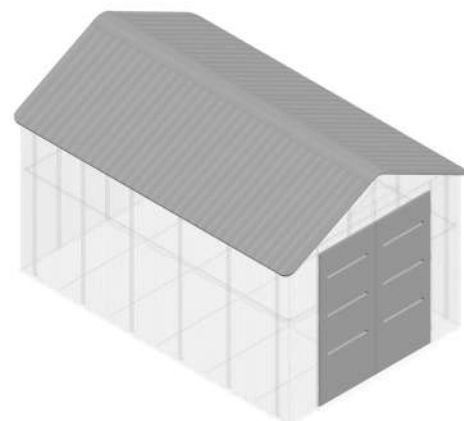

28



D59-pa x16



D58-pa x8

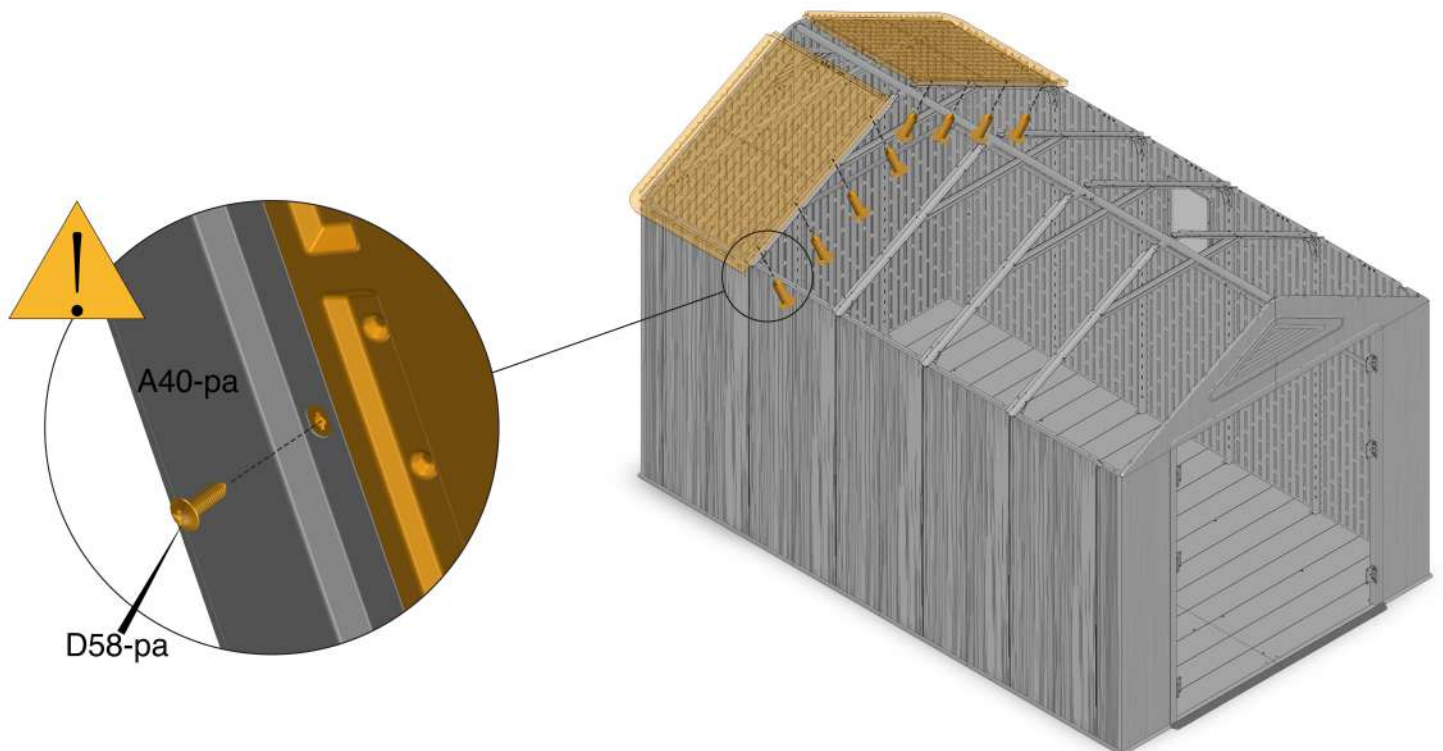
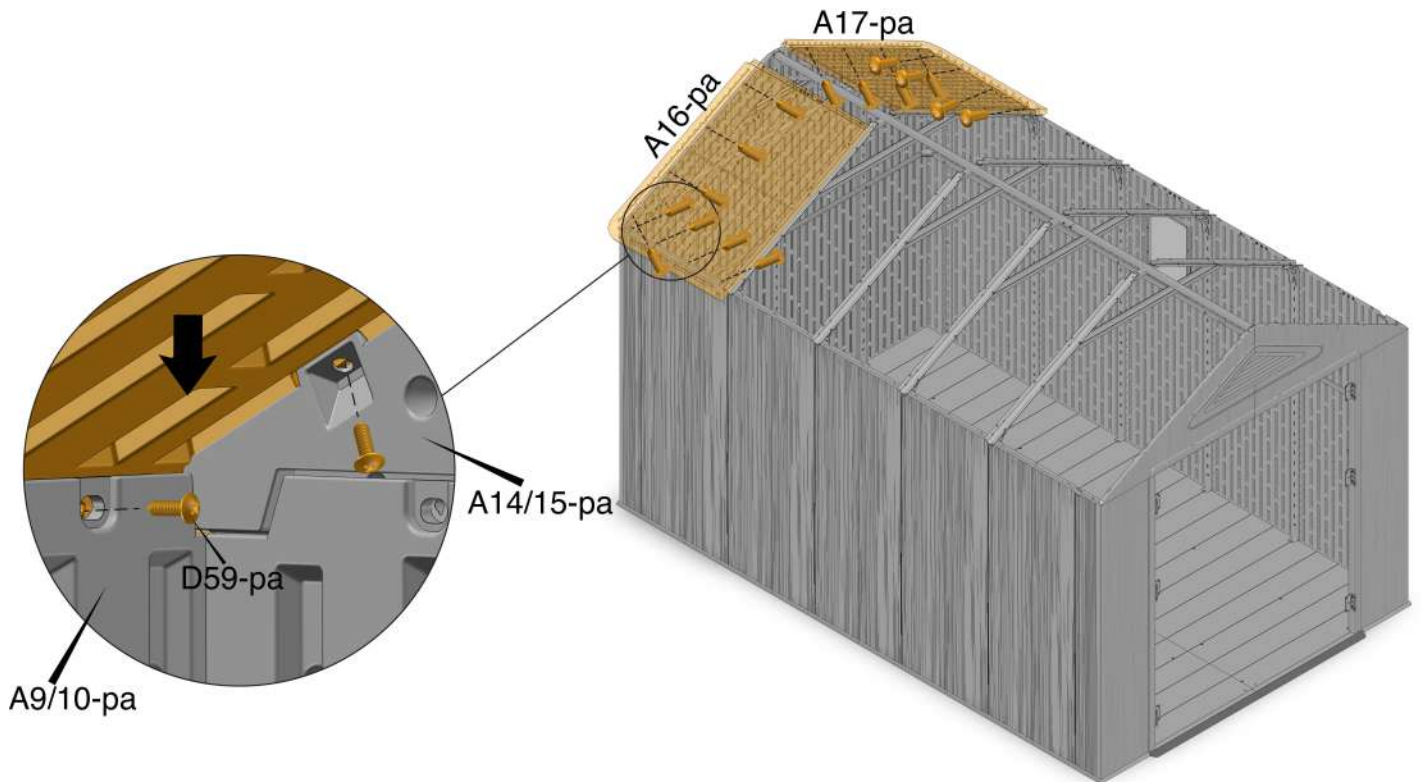

29



A19-pa x1



D59-pa x12

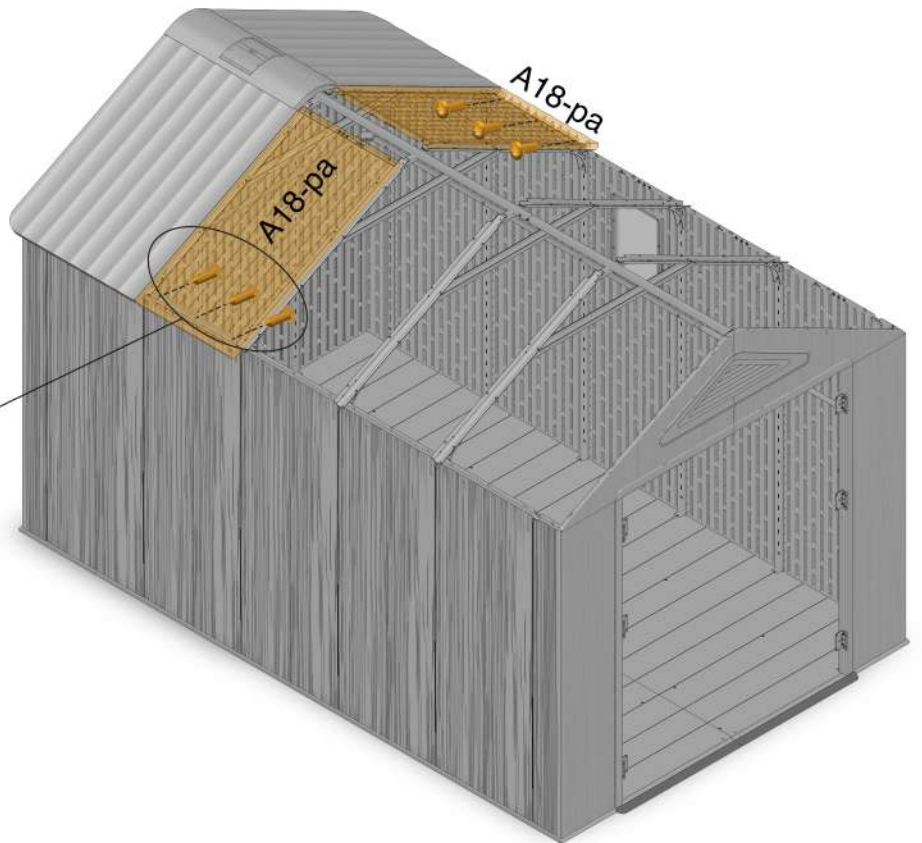
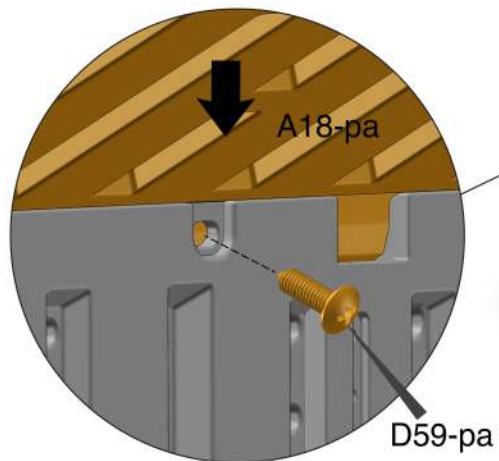
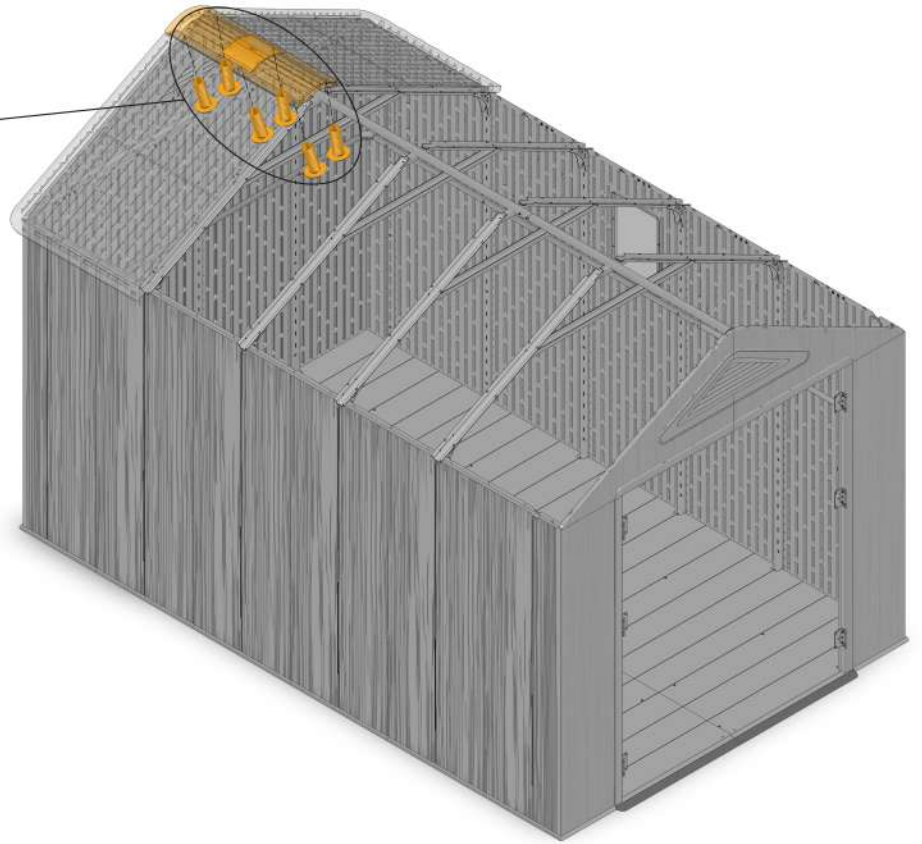
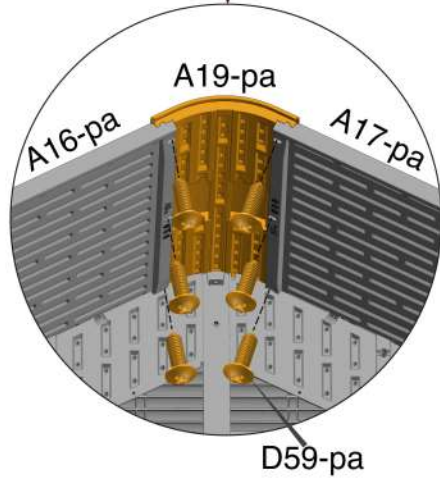
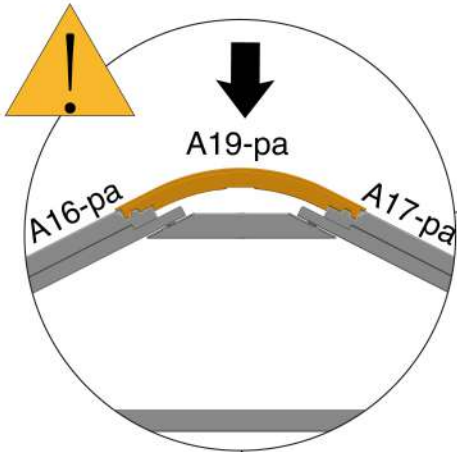

30



A21-pa x1



D58-pa x16



D59-pa x4

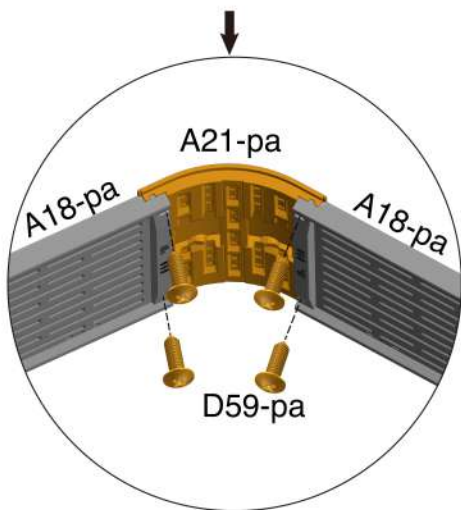
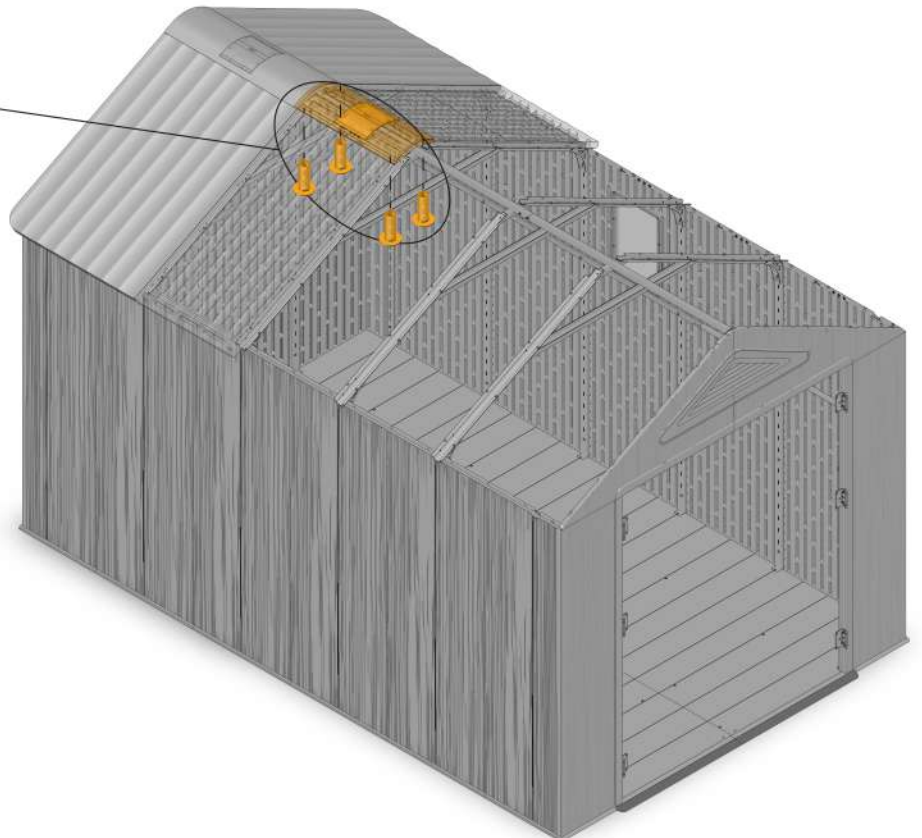
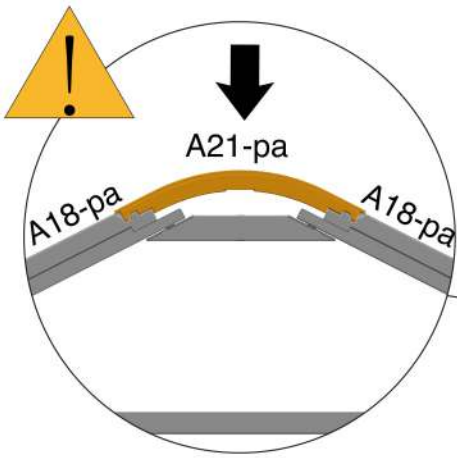
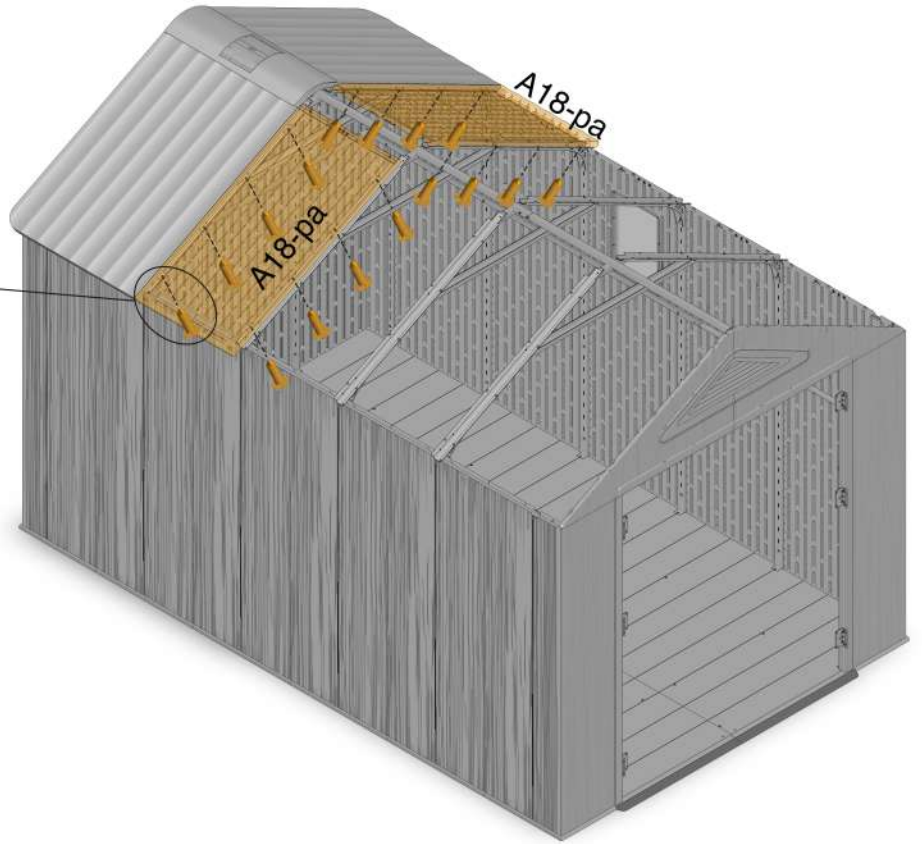
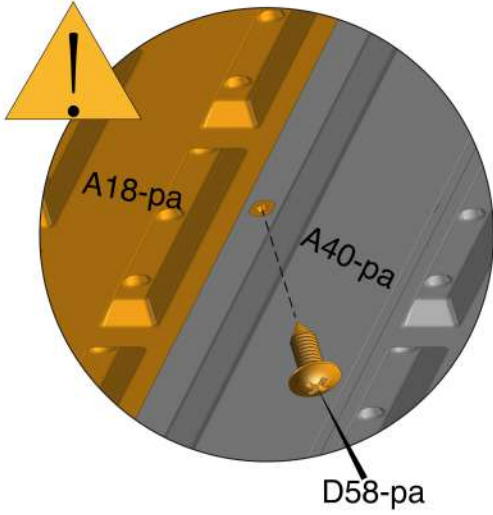

31



D59-pa x6



D58-pa x16

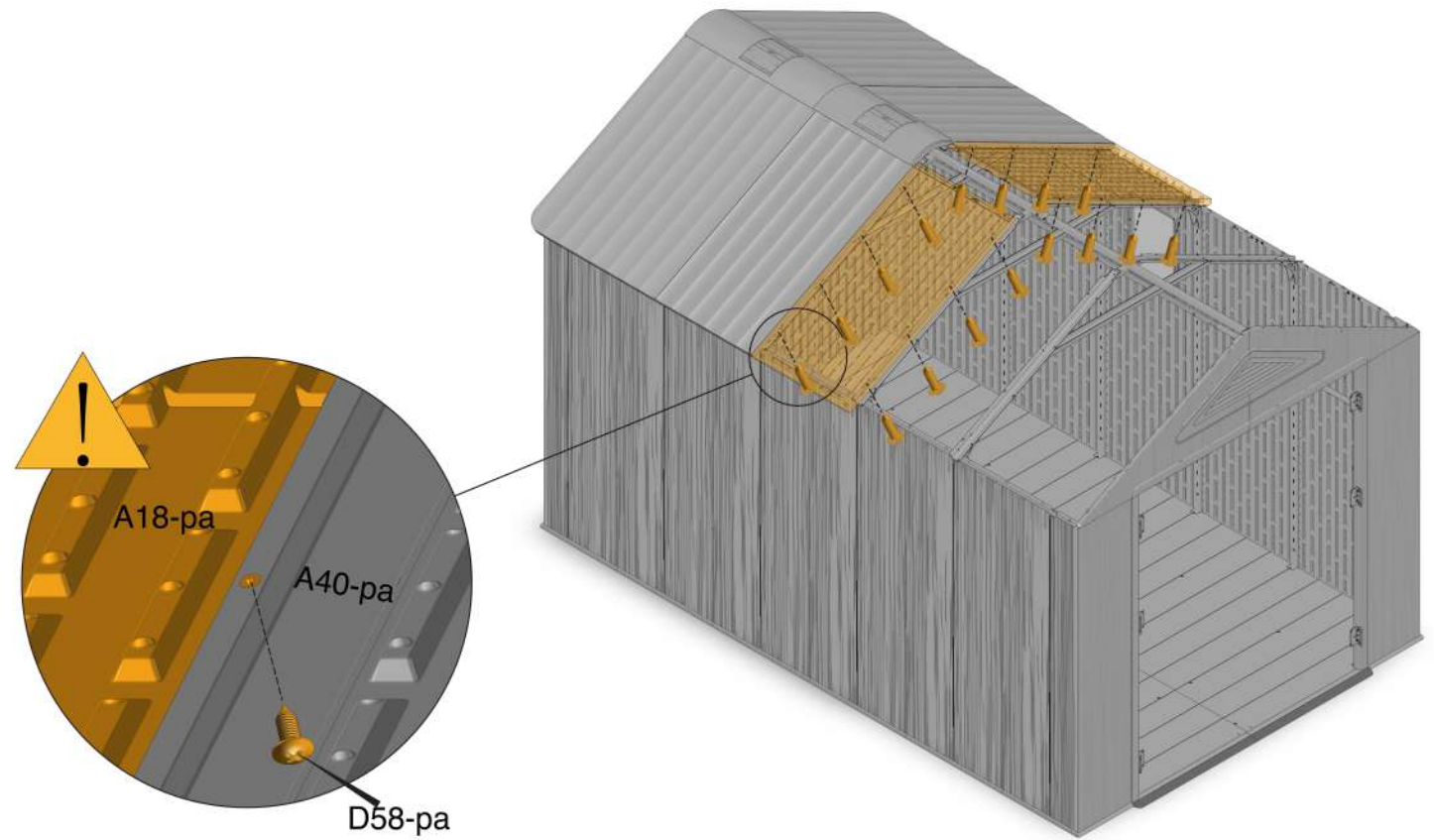
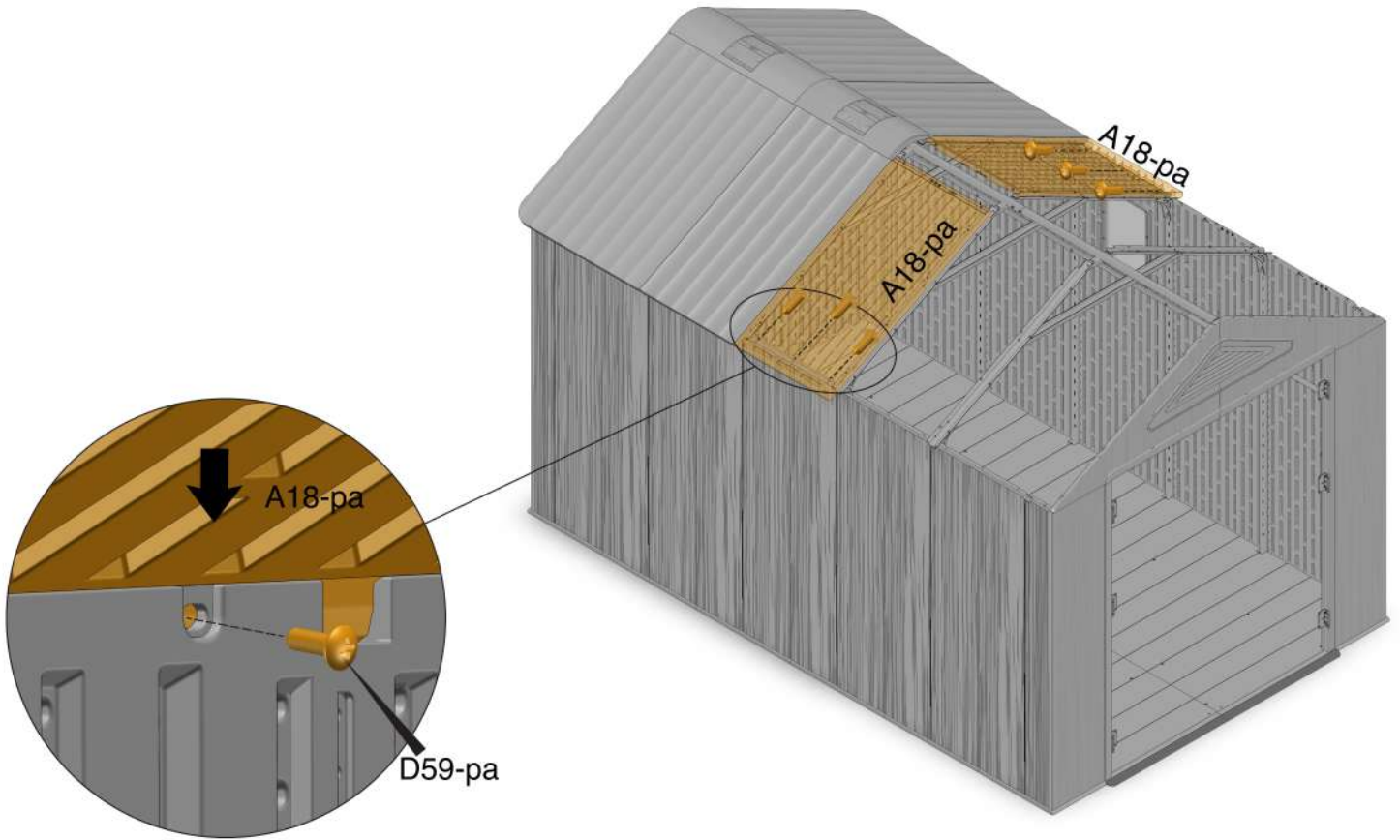

32



A21-pa x1



D59-pa x10

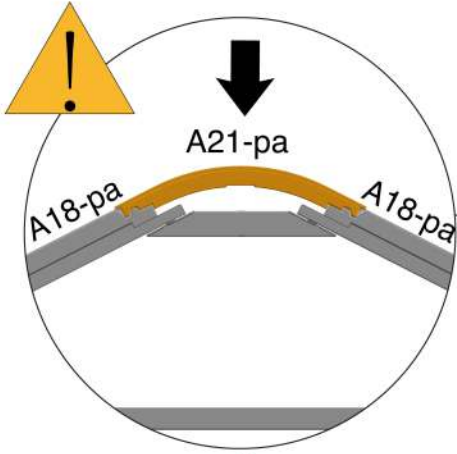

A21-pa
A18-pa A18-pa

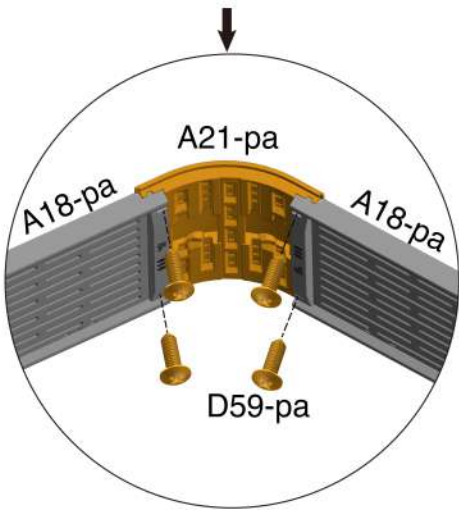

A21-pa
A18-pa A18-pa
D59-pa

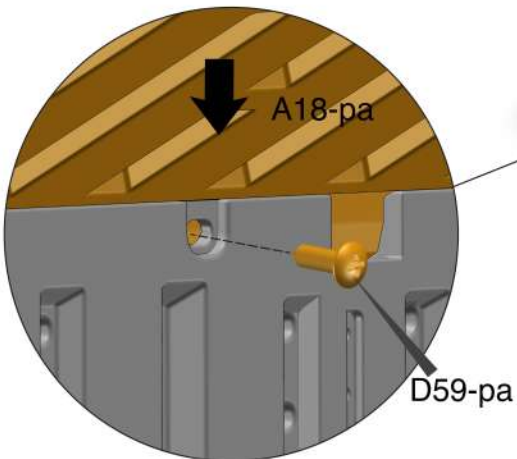
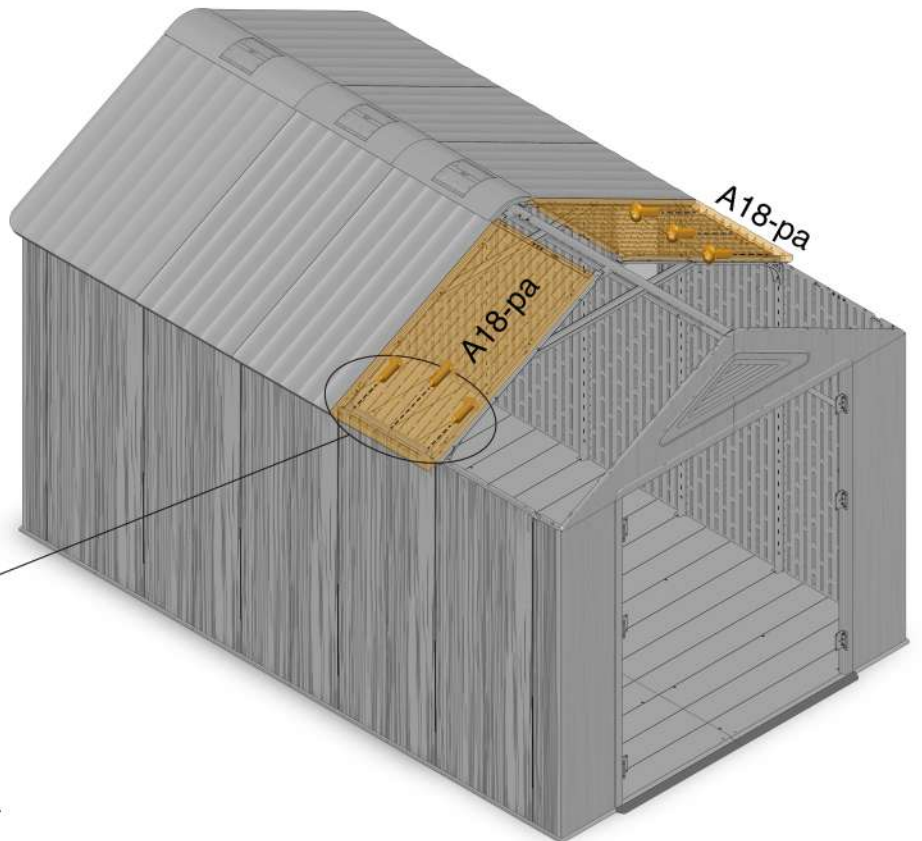
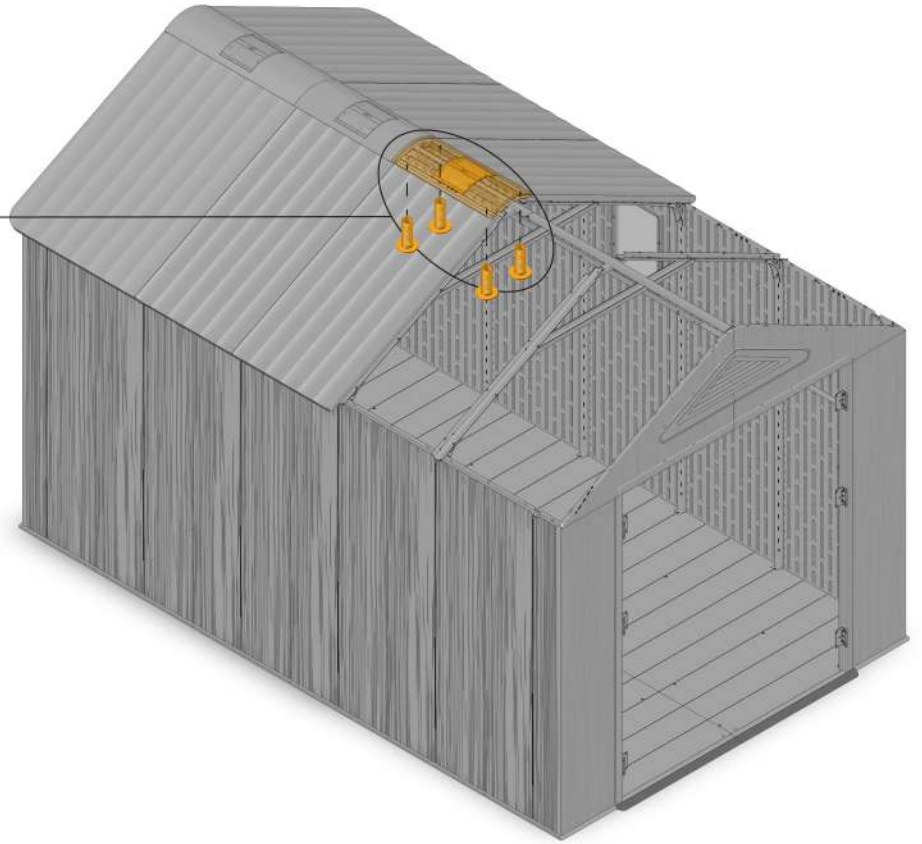

A18-pa

D59-pa

33



A21-pa x1



D58-pa x16



D59-pa x4

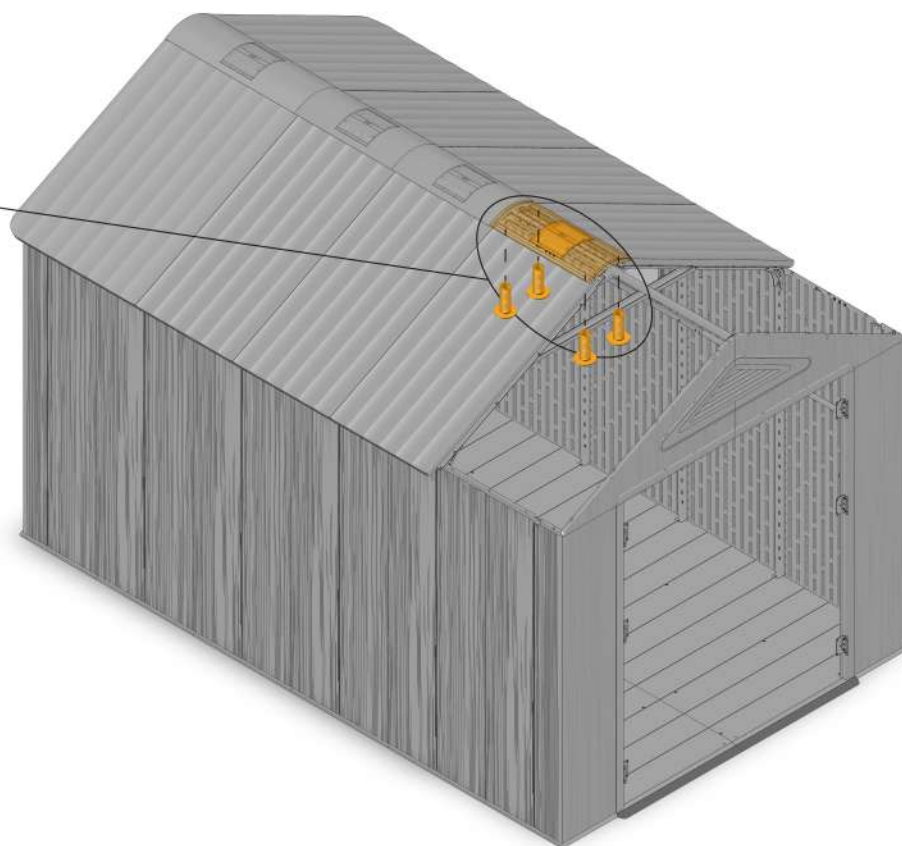
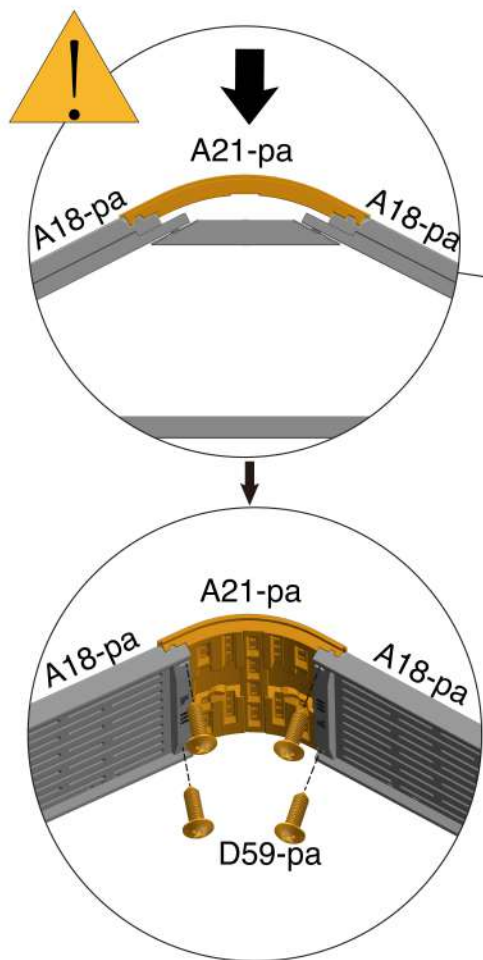
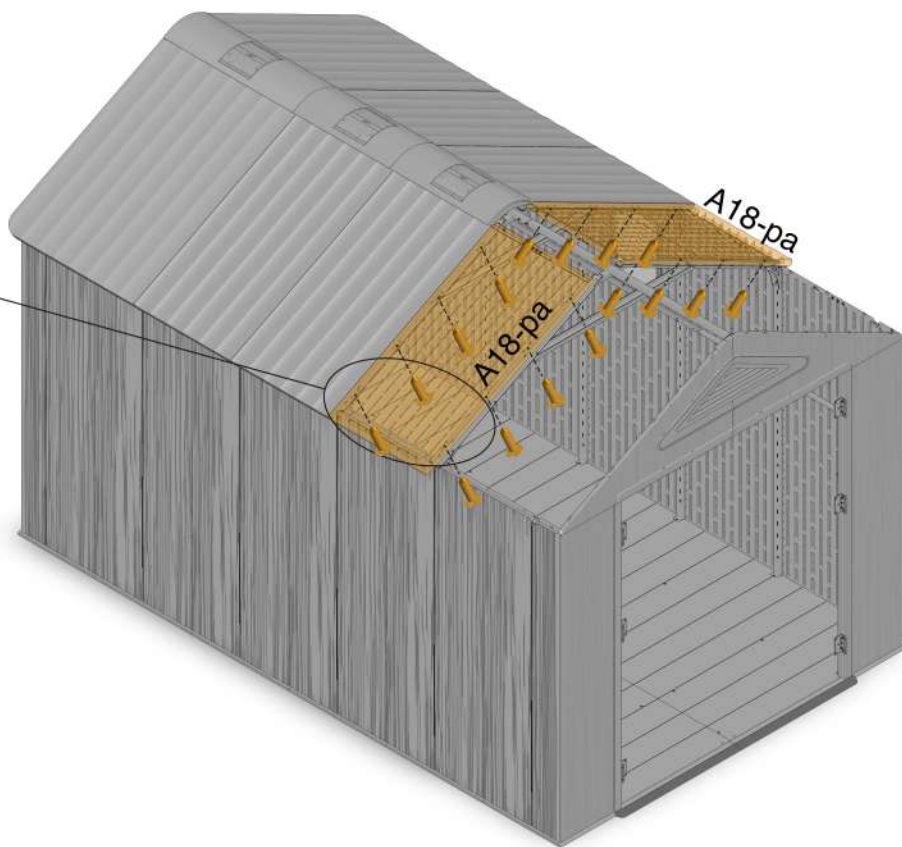
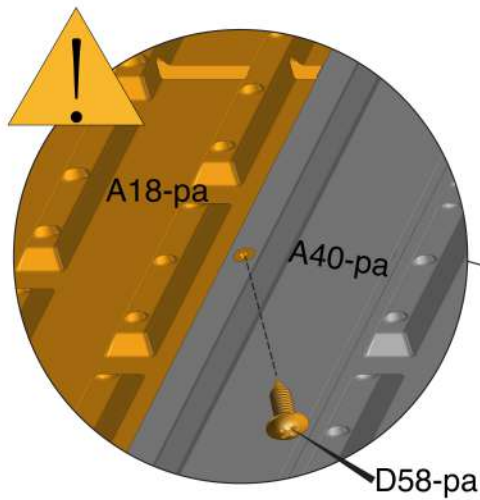

34



D59-pa x16



D58-pa x8

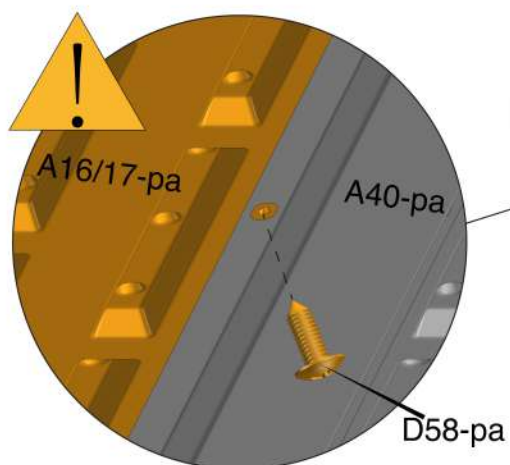
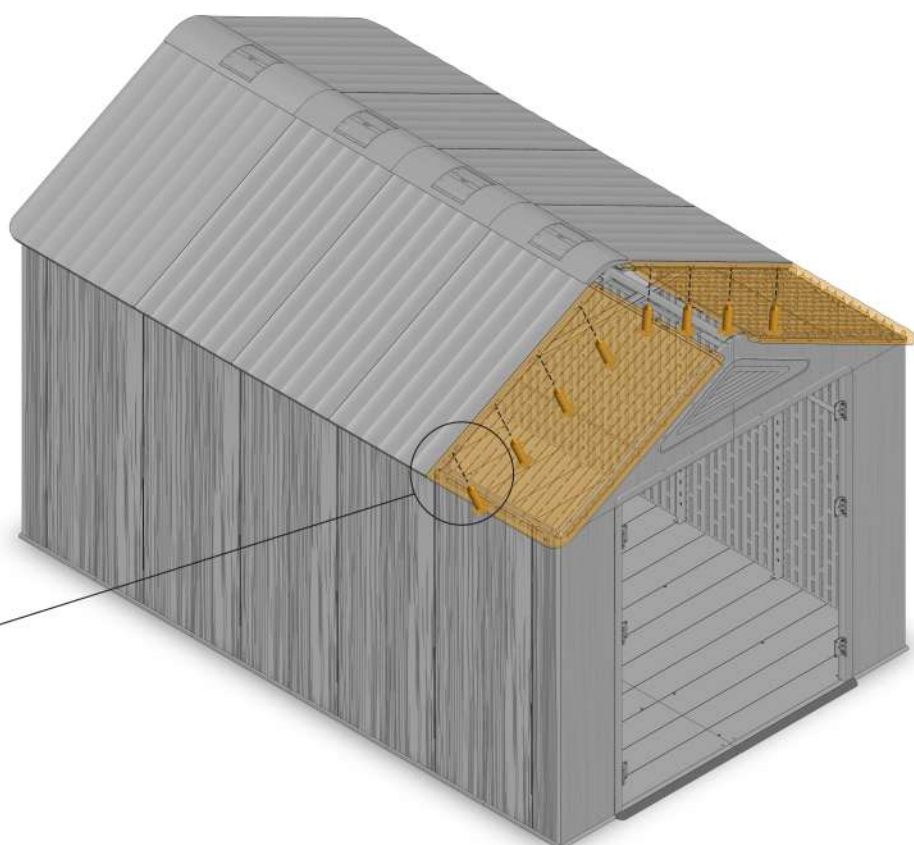
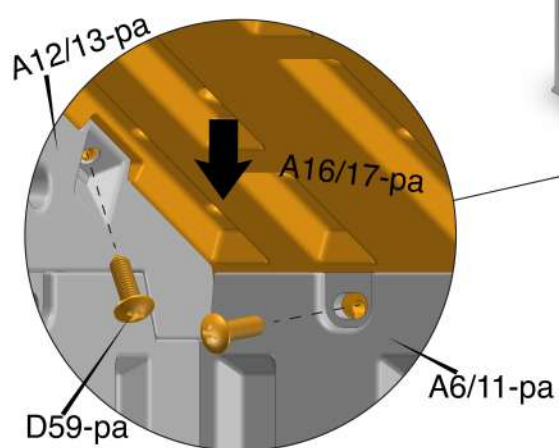

35



A20-pa x1



D59-pa x6

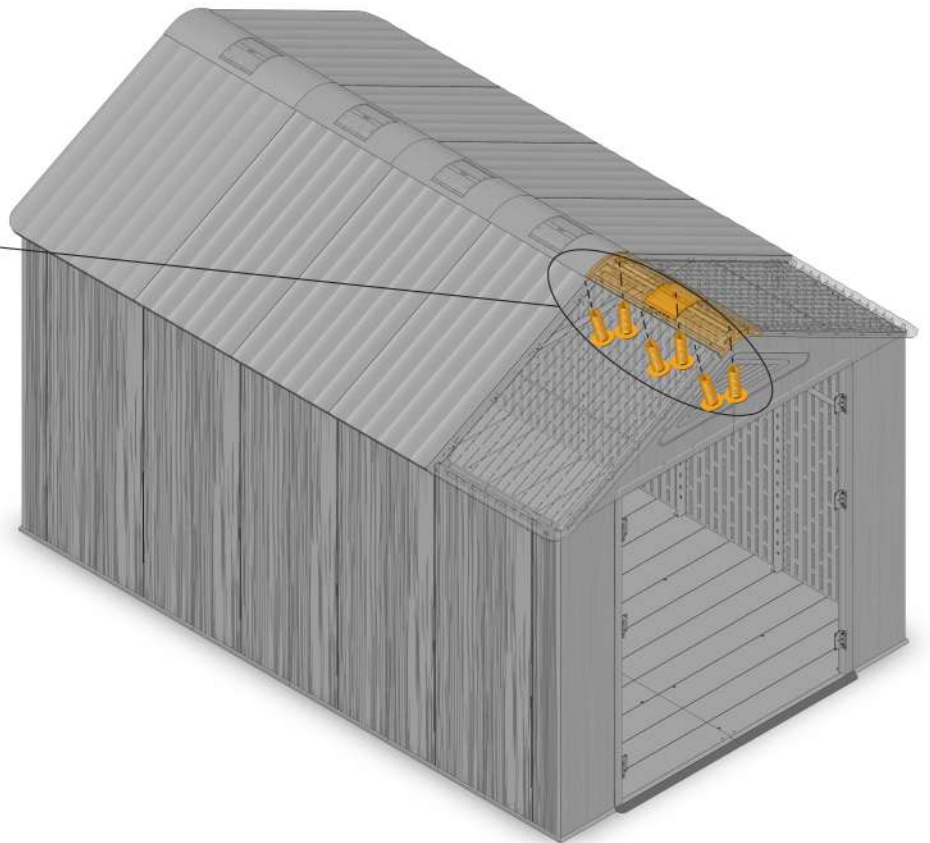
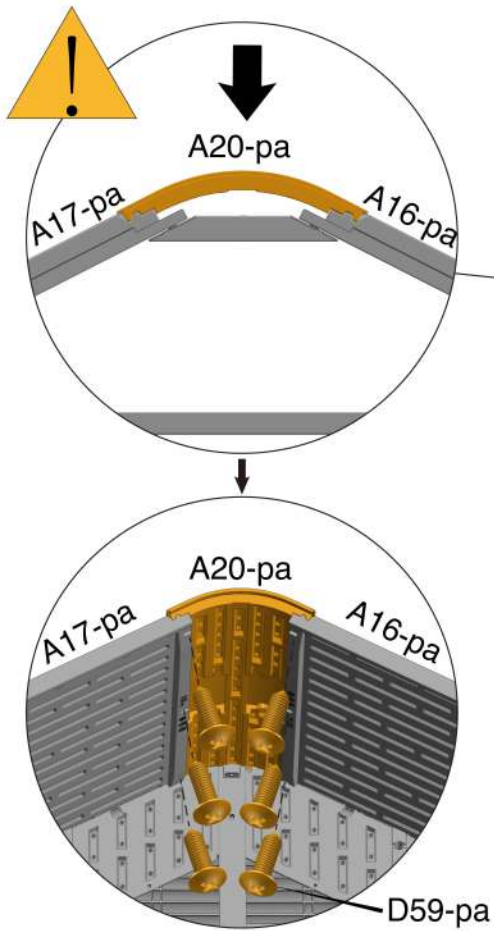

36



A22-pa x1



A23-pa x1



A34-pa x2



A34a-pa x2



D57-pa x20

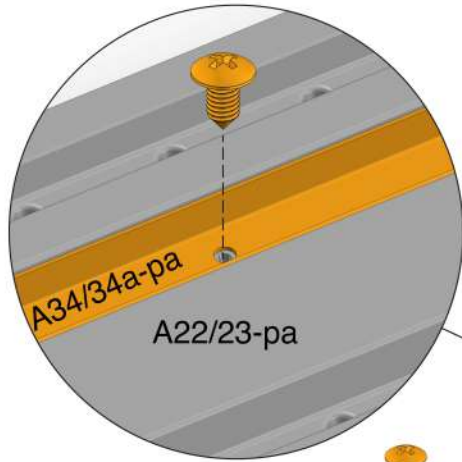

A22/23-pa

A34/34a-pa

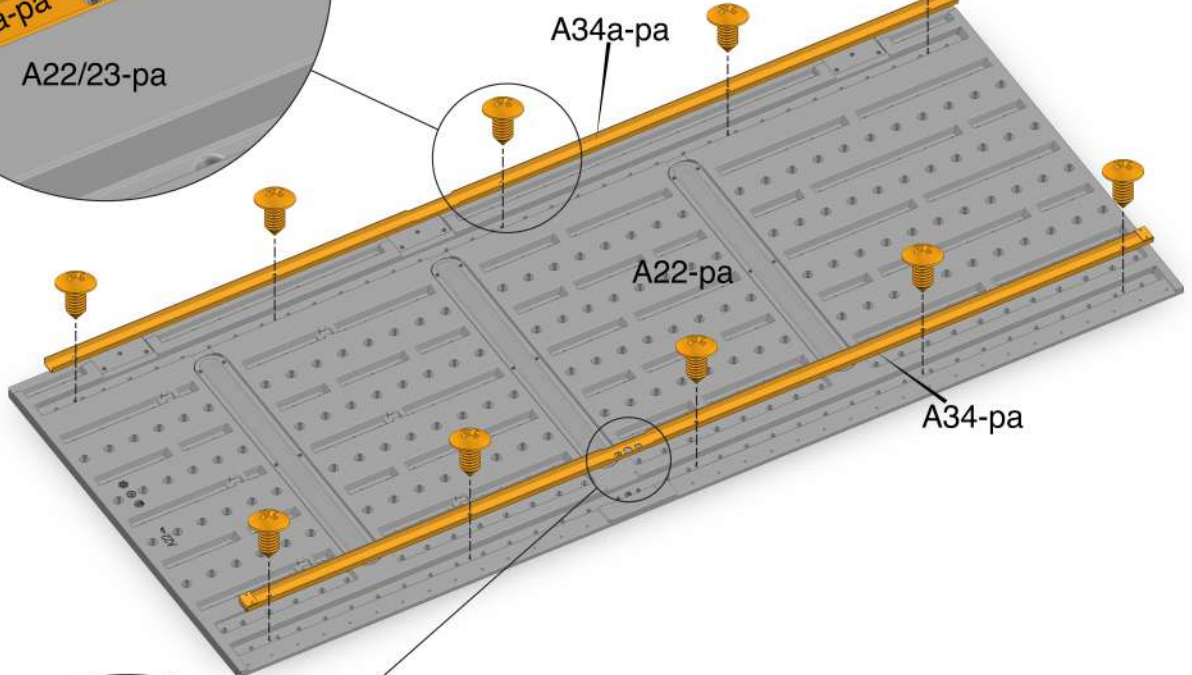

A34a-pa

A22-pa

A34-pa

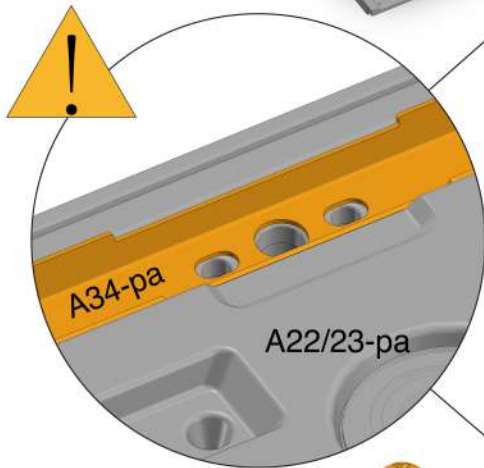

A34-pa

A22/23-pa

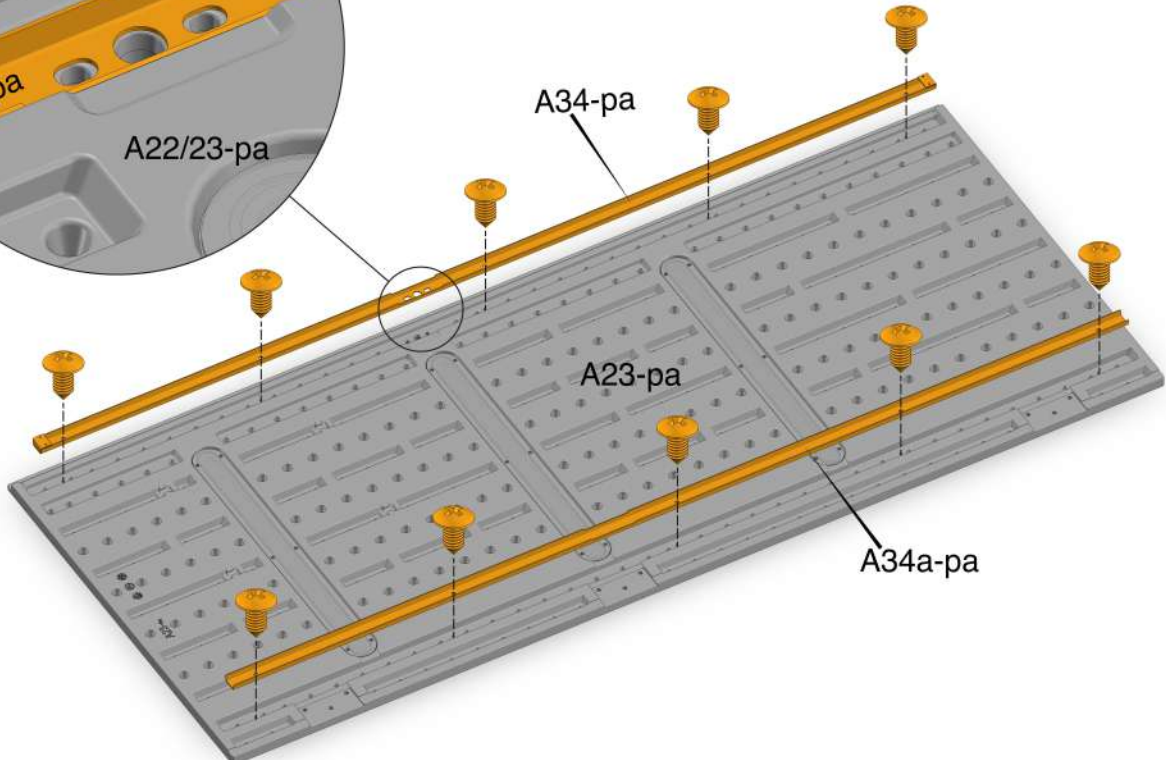

A34-pa

A23-pa

A34a-pa

37



13-pa x2



14-pa x2



D51-pa x8

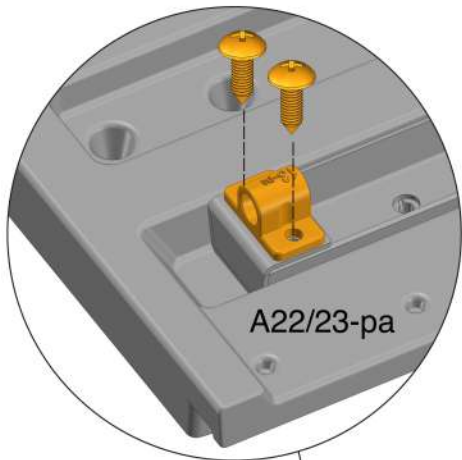

A22/23-pa

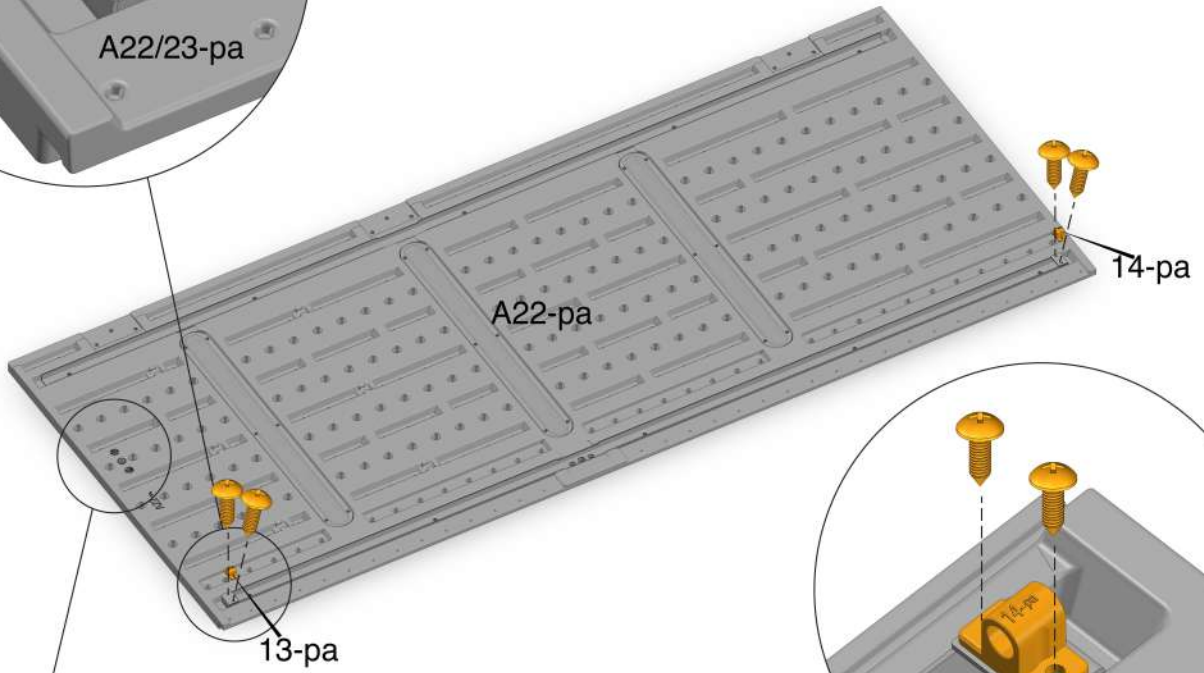

A22-pa

14-pa

13-pa

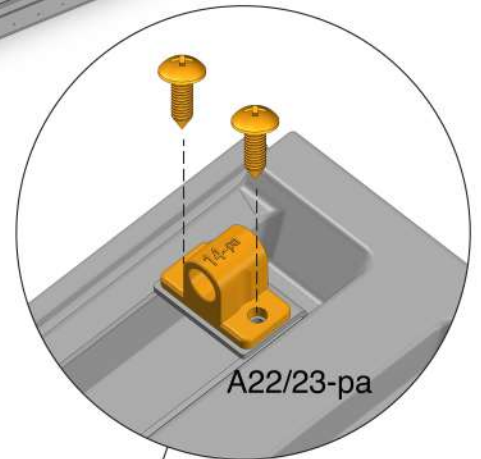

A22/23-pa

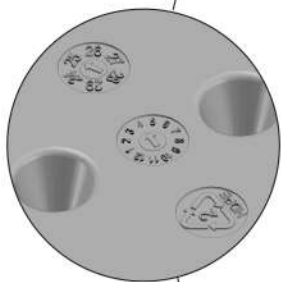

13-pa

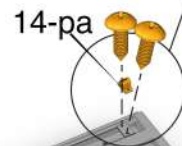

14-pa

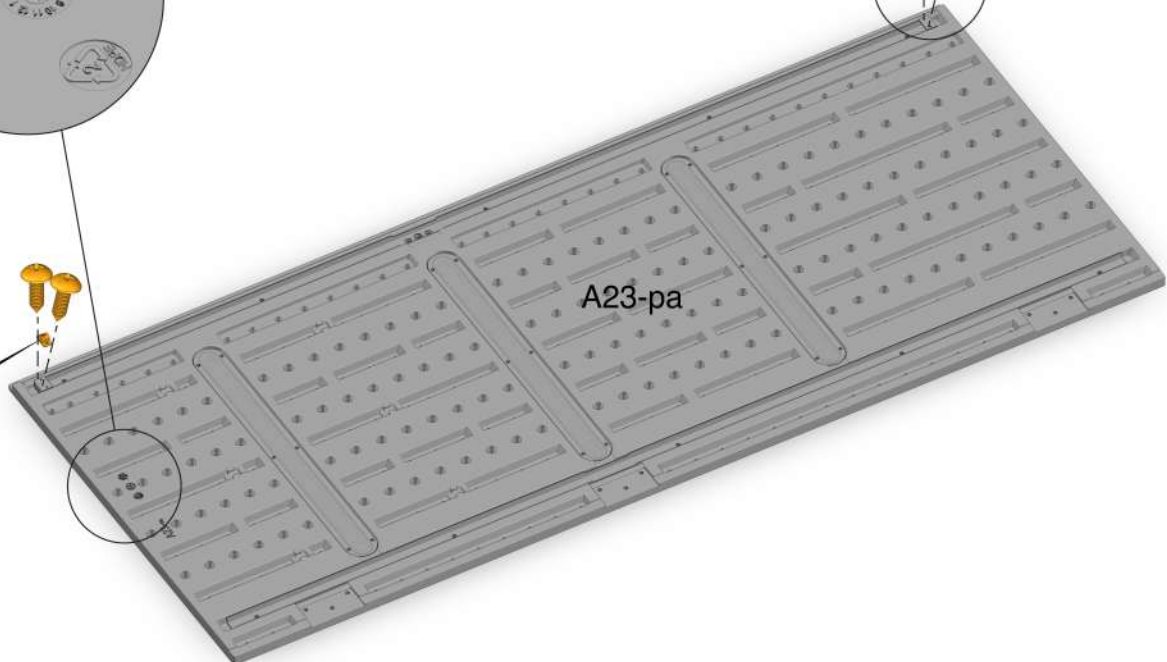

A23-pa

38



D53-pa x9

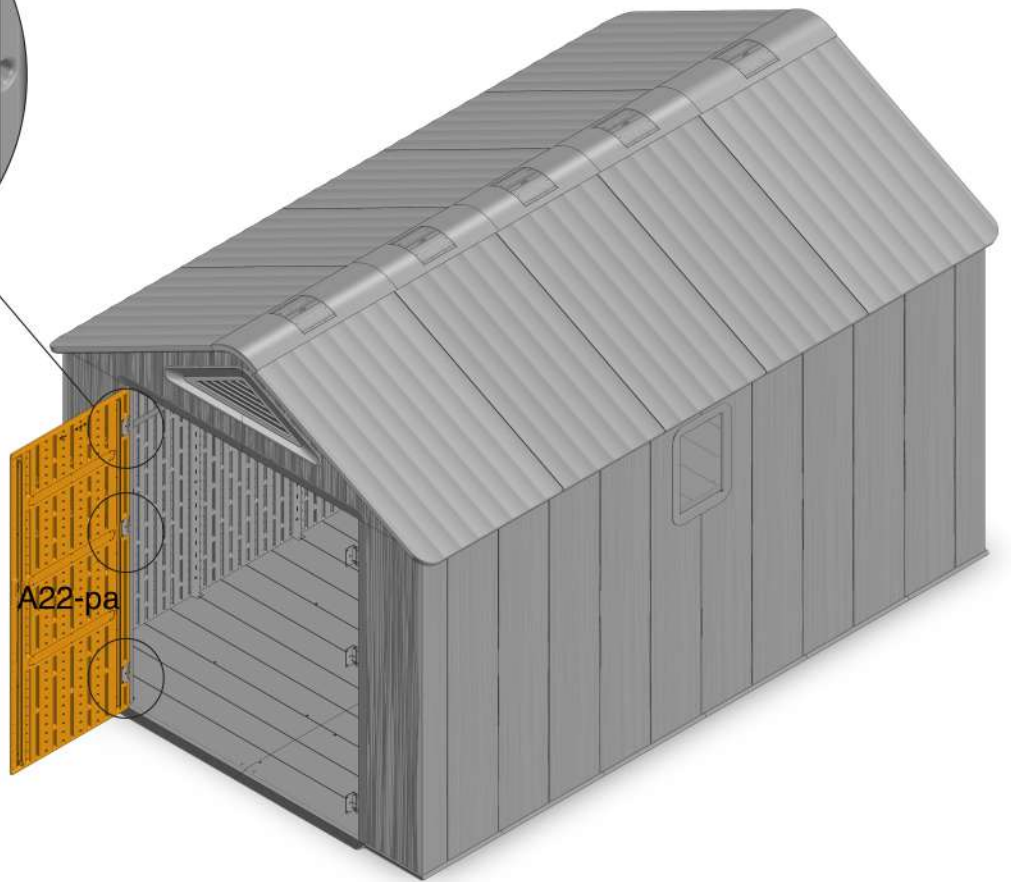
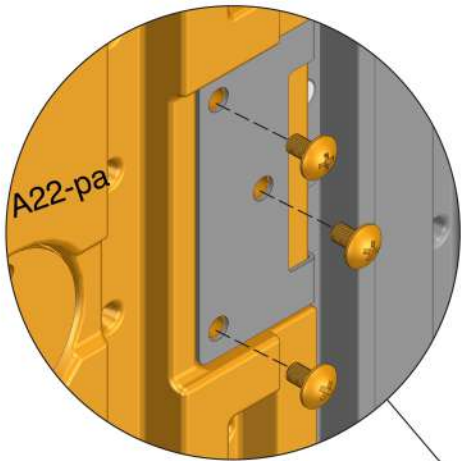

39



1-pa x1



1.1-pa x2



1.2-pa x2



1.3-pa x1



1.4-pa x1



1.5-pa x1



7-pa x1

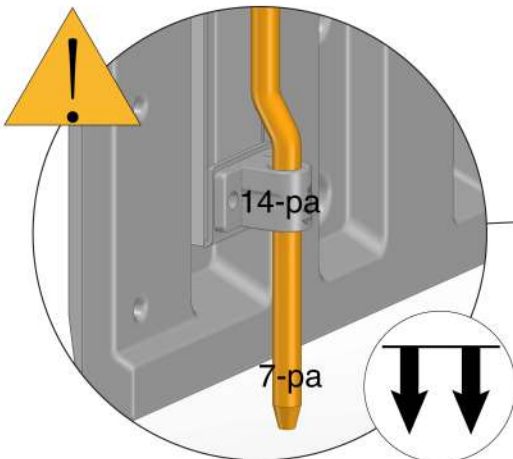
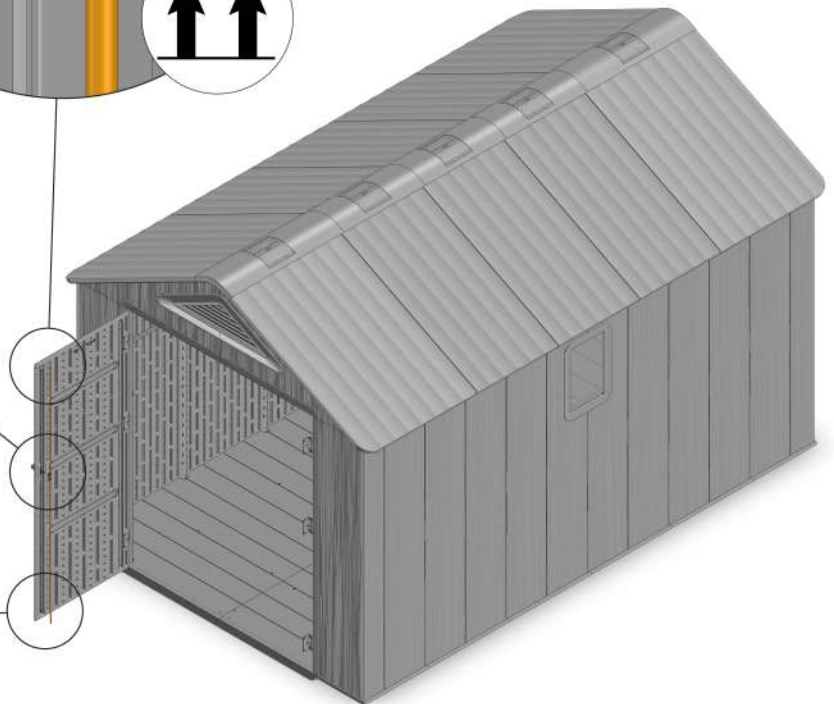
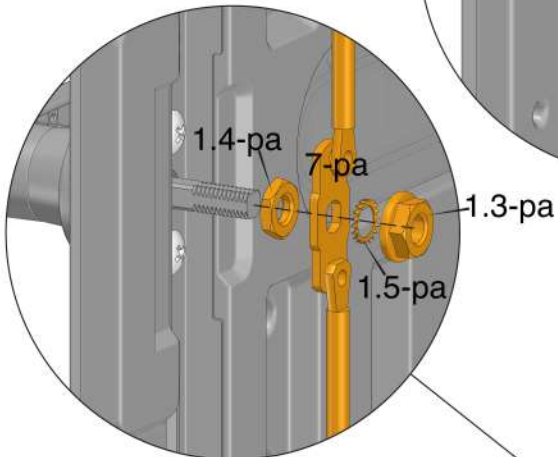
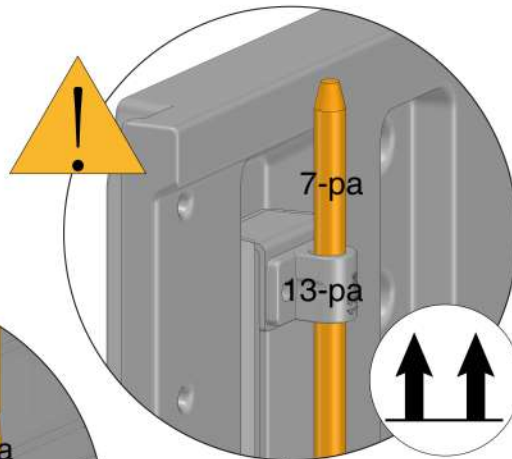
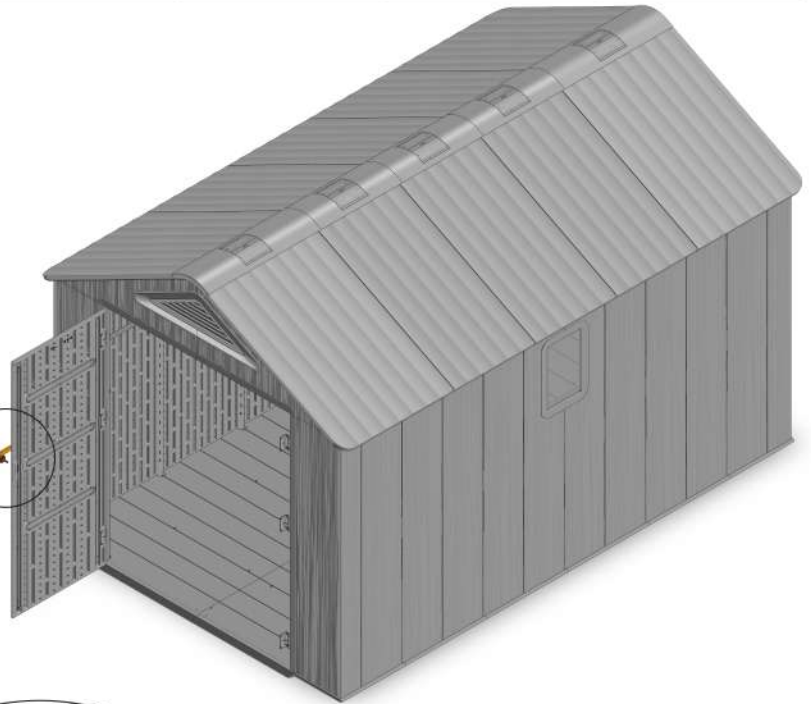
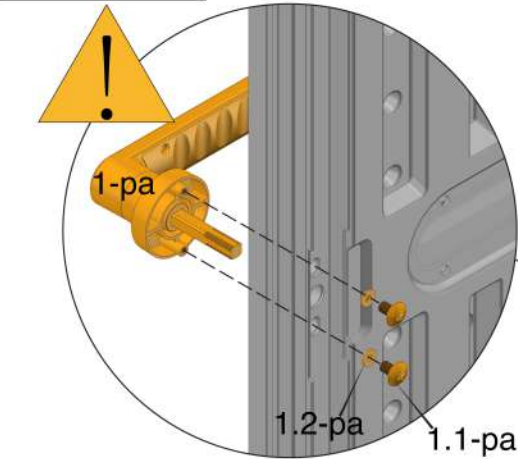

40

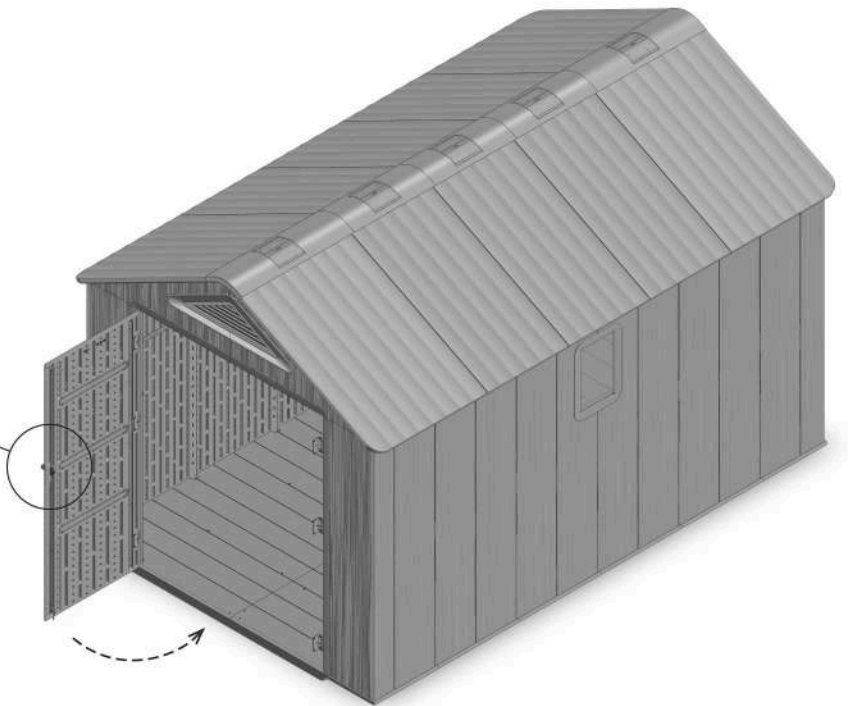
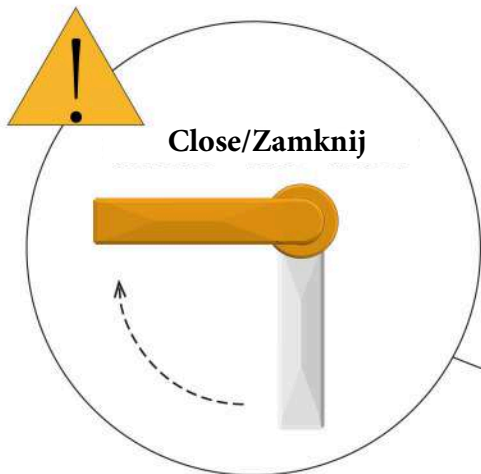
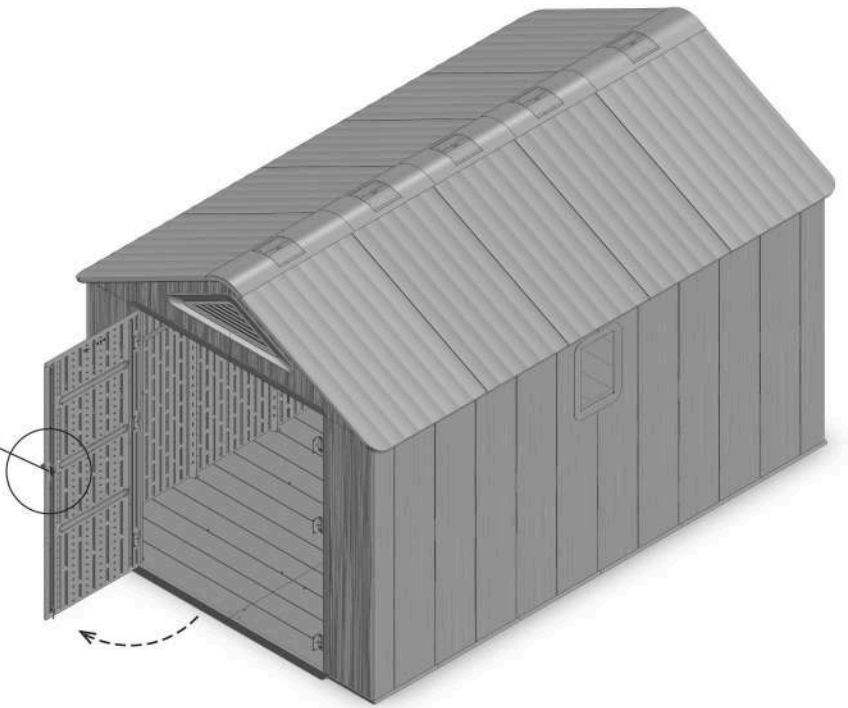
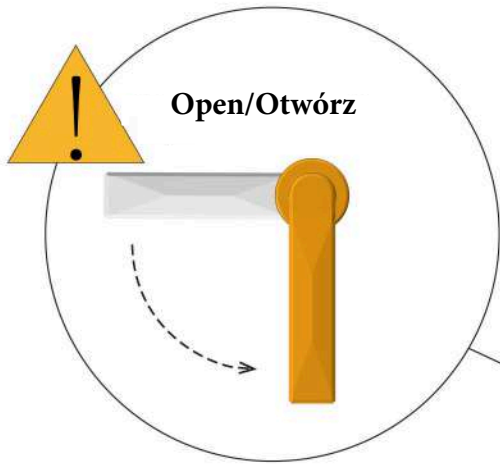

41



D53-pa x9

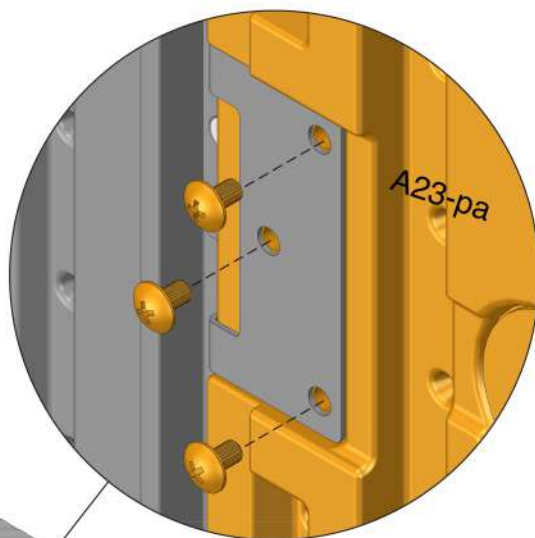
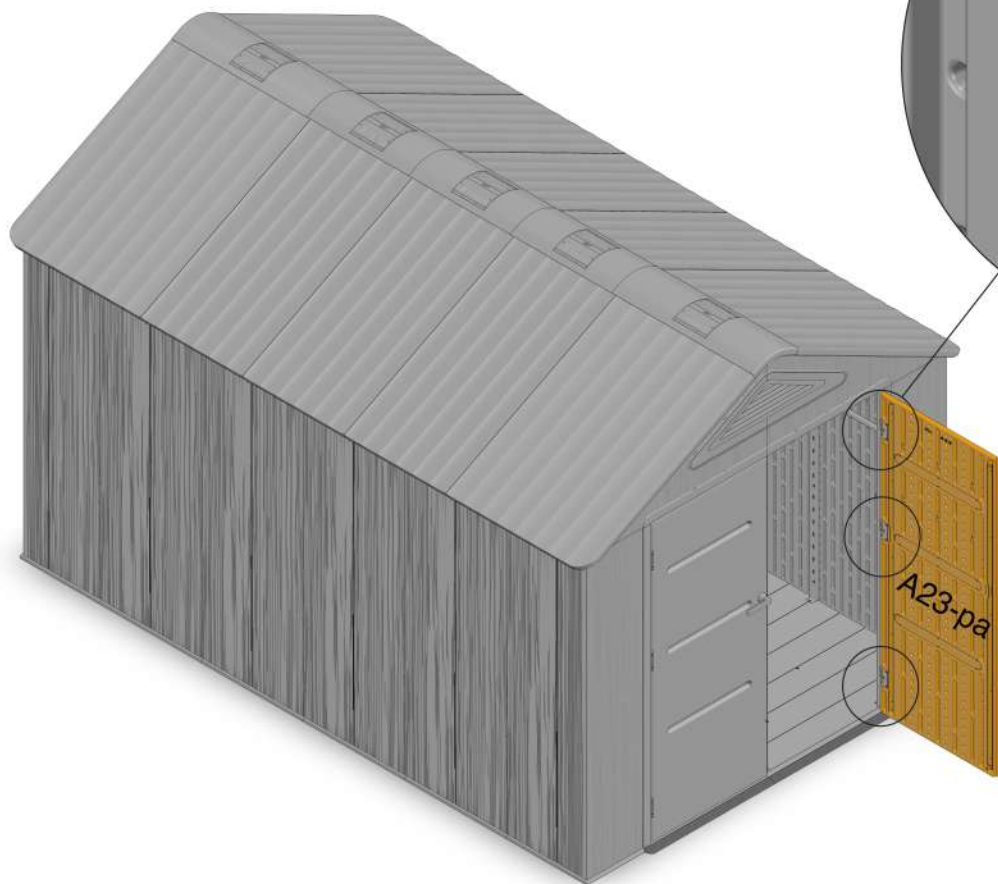

42



2-pa x1



1.1-pa x2



1.2-pa x2

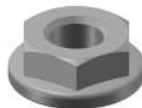

1.3-pa x1



1.4-pa x1



1.5-pa x1



8-pa x1

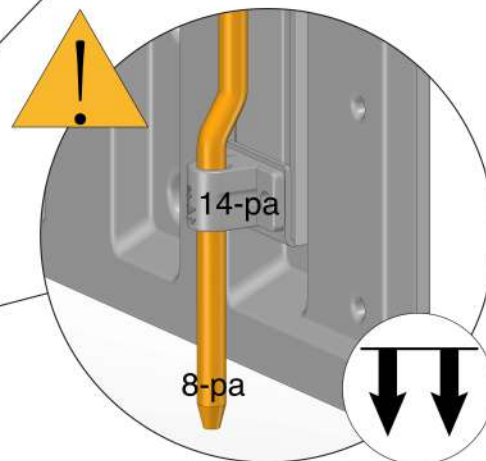
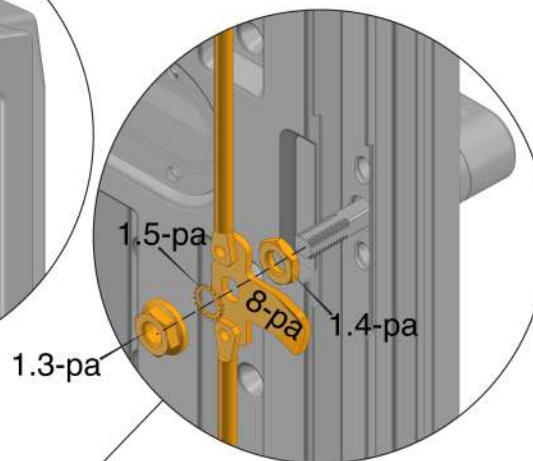
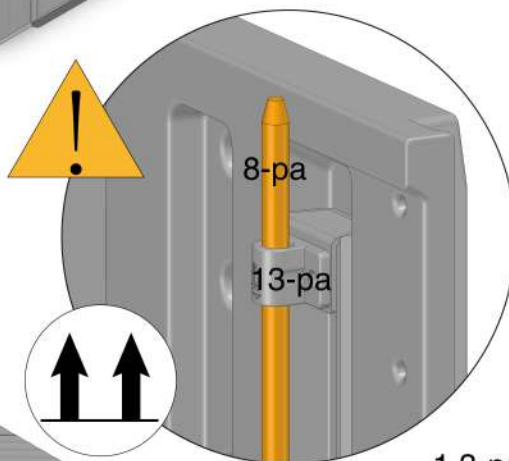
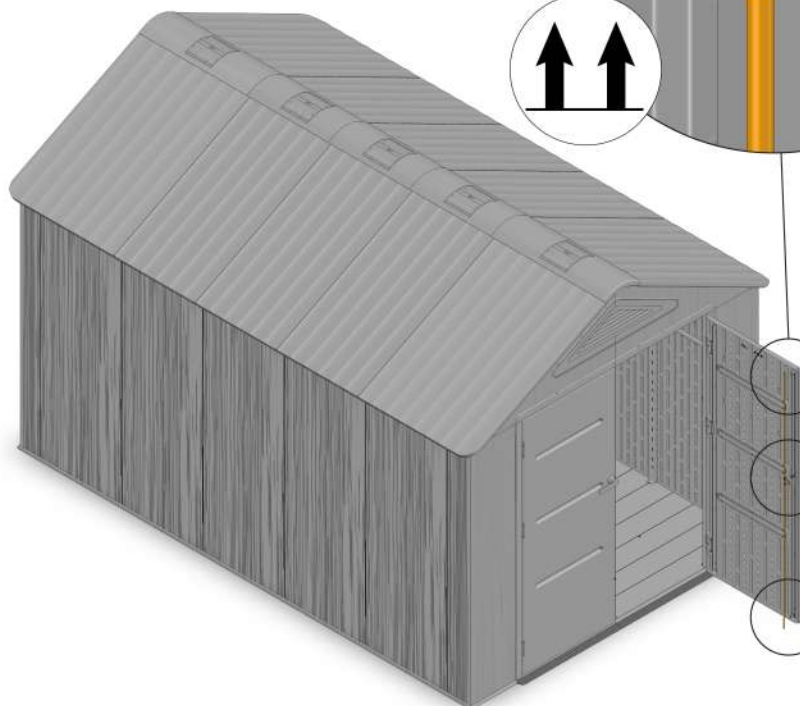
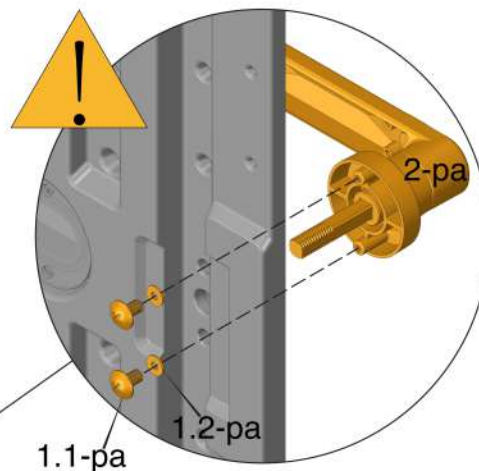
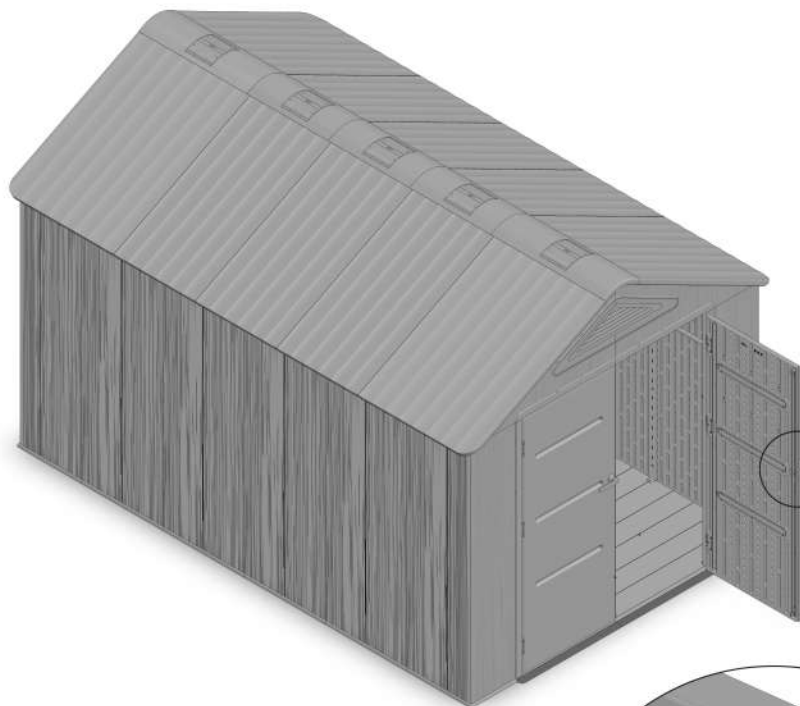

43

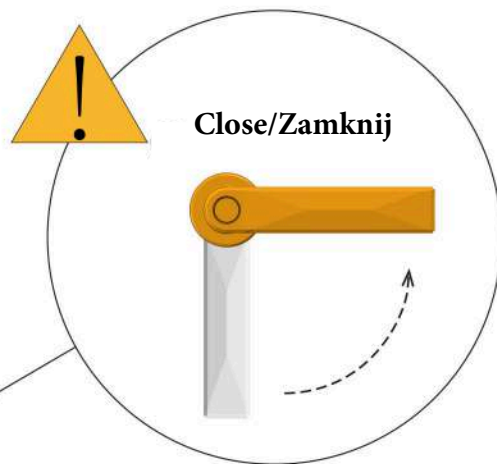
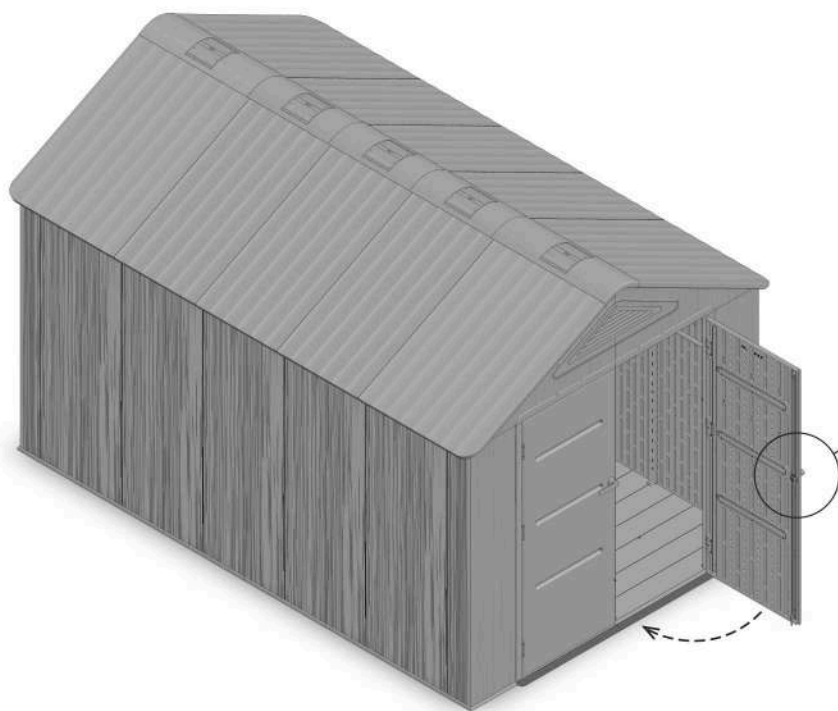
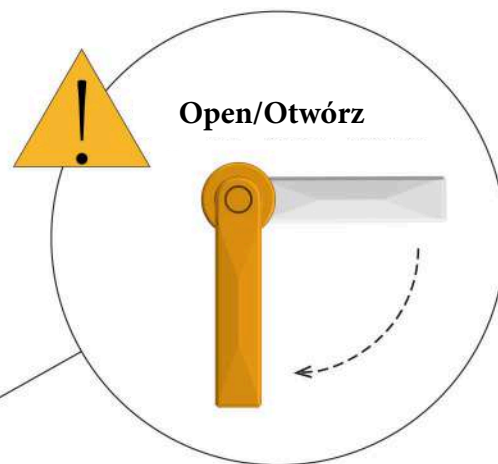
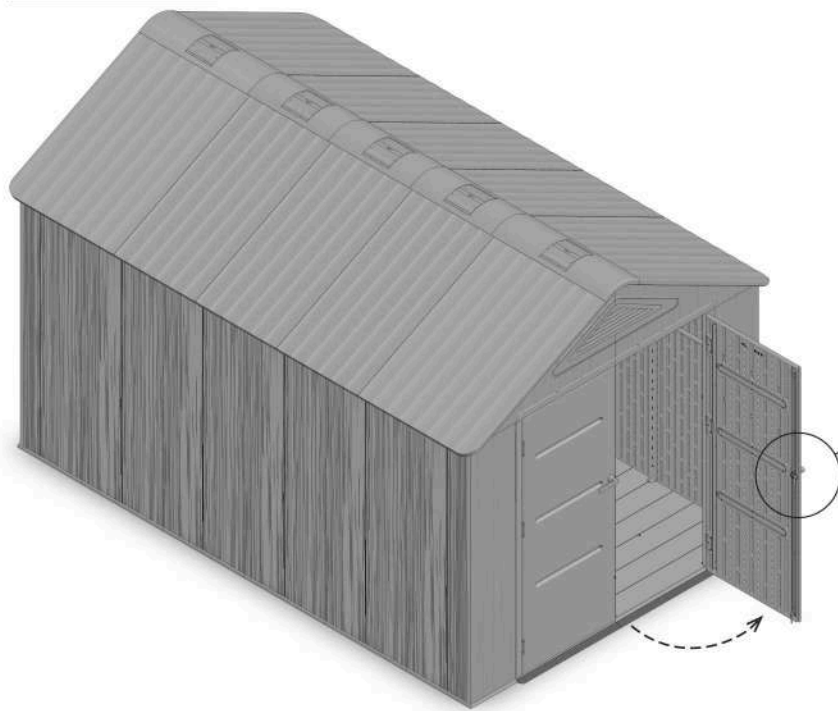

44



11-pa x5

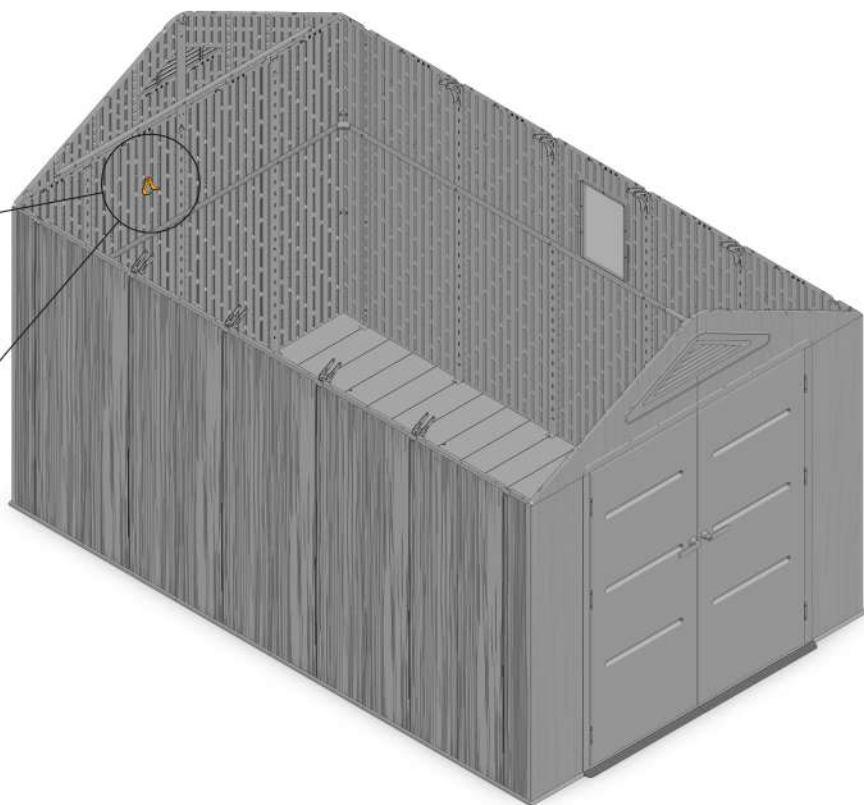
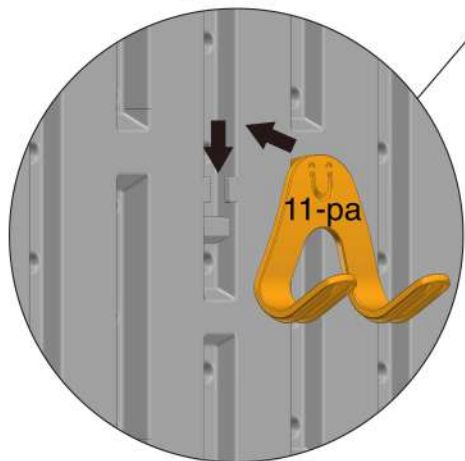
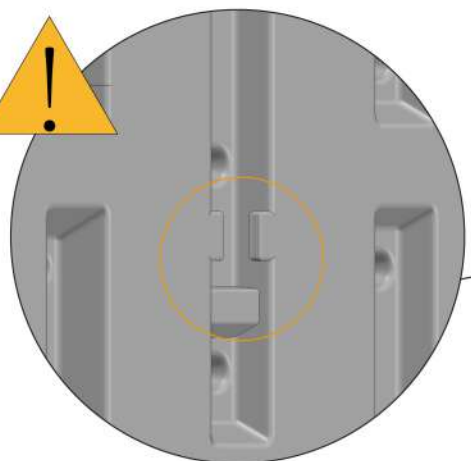

<h1>45</h1>	 <p>19-pa x2</p>
-------------	--

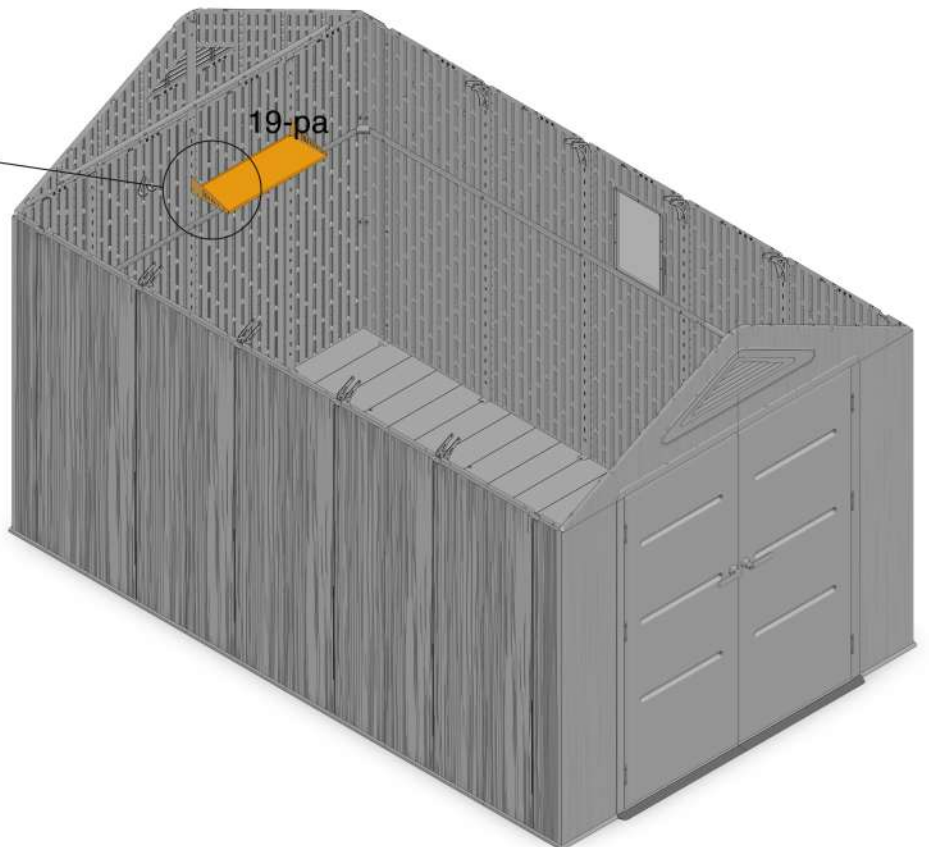
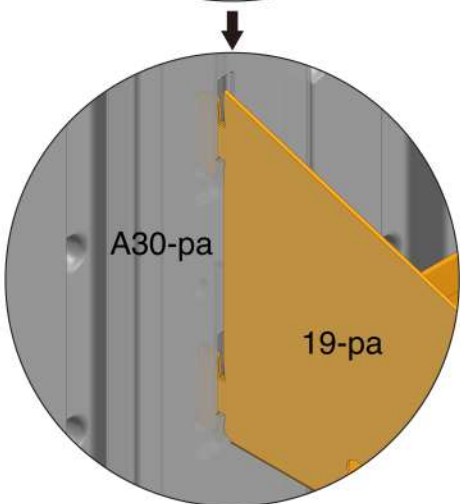
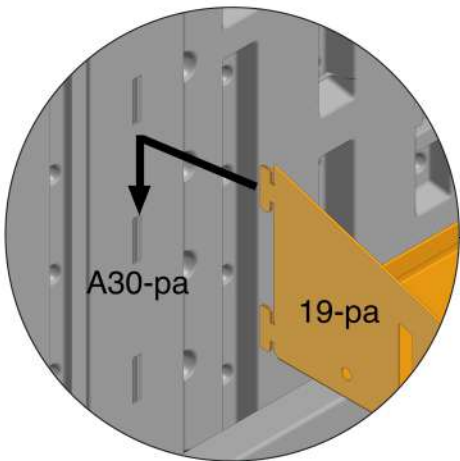
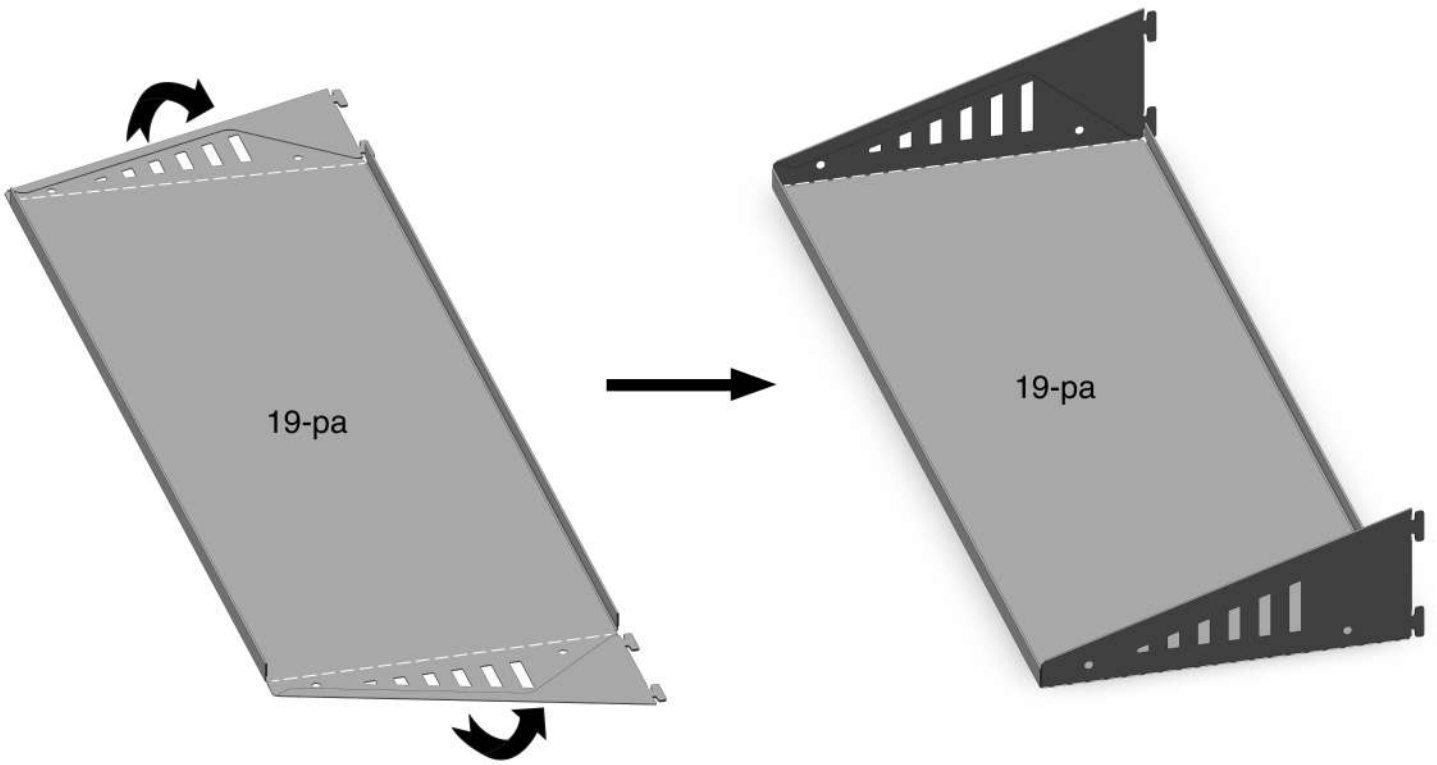

46



D60-pa x17

Montaż na drewnianej podstawie/ Assembly on a wooden base

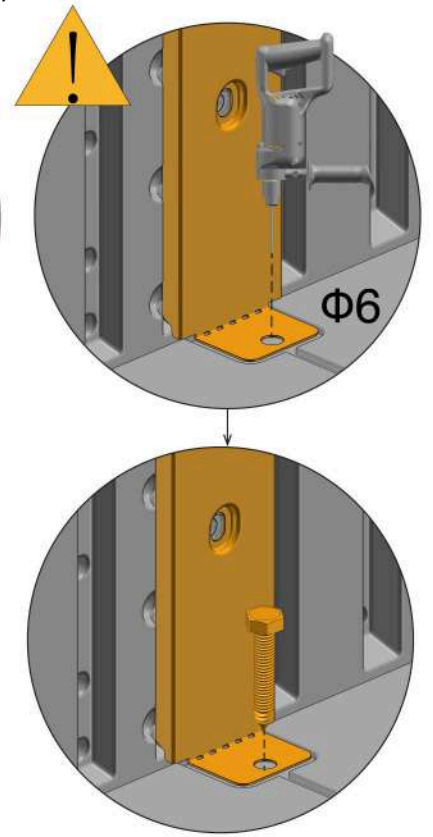
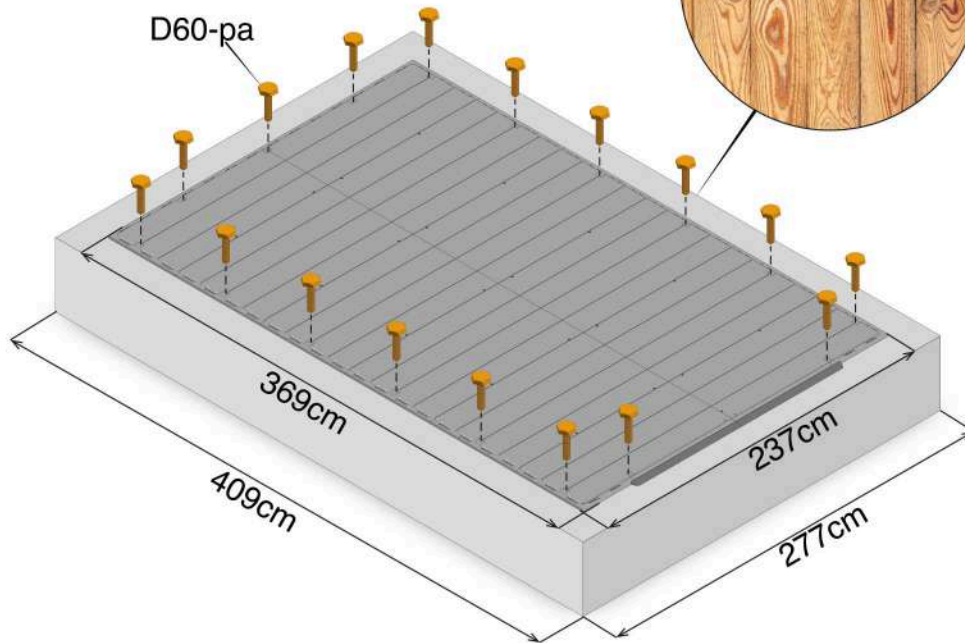

Montaż na betonowej podstawie/ Assembly on a concrete base

