

EVEREST 8x8 Domek z tworzywa/Plastic shed

Instrukcja montażu/Assembly instructions

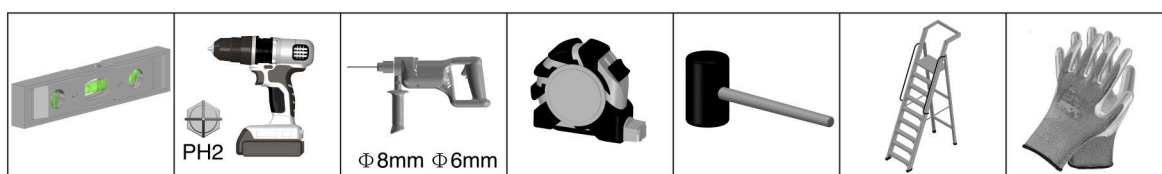

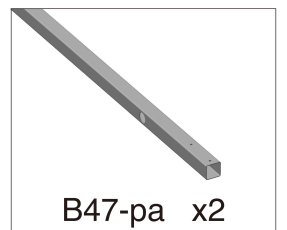

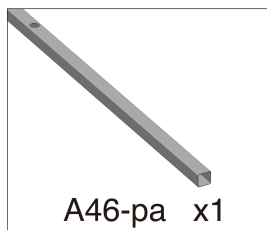
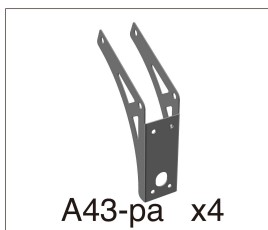
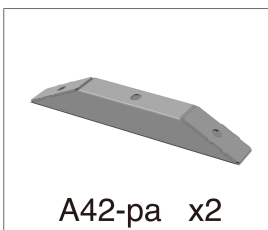
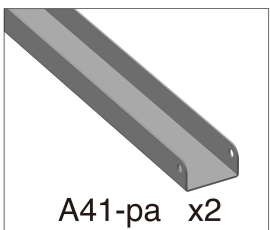
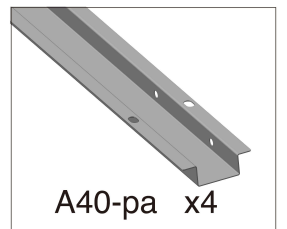
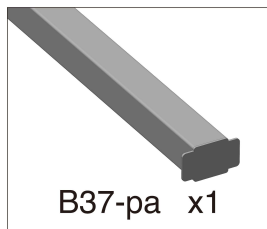
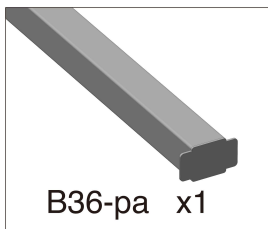
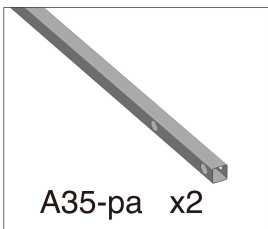
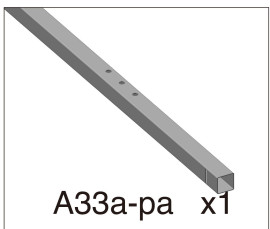
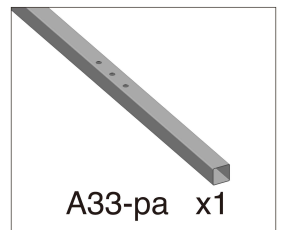
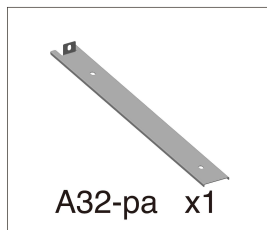
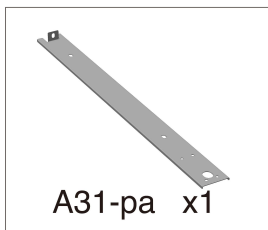
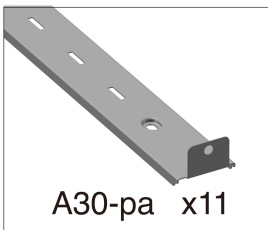
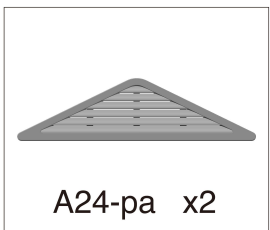
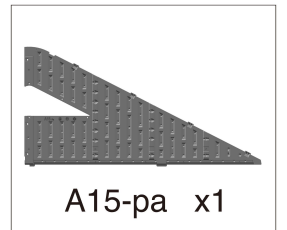
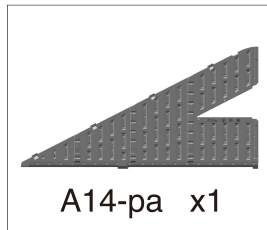
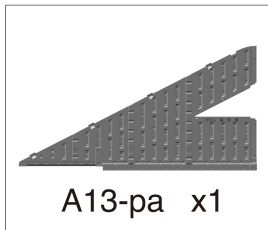
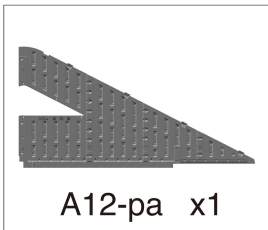
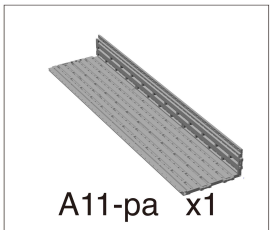
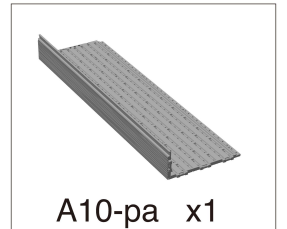
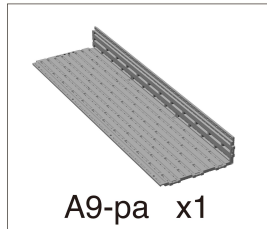
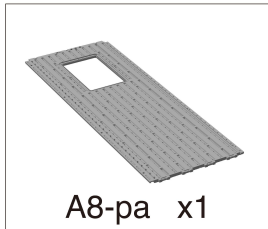
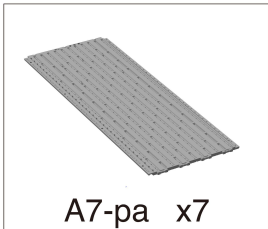
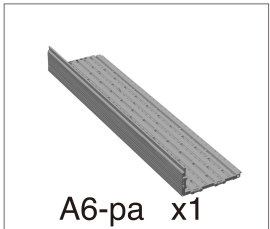
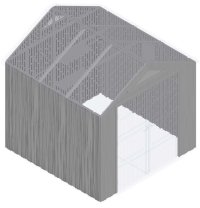
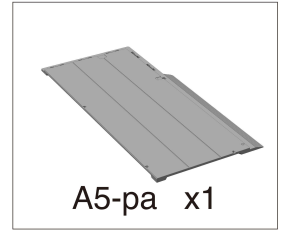
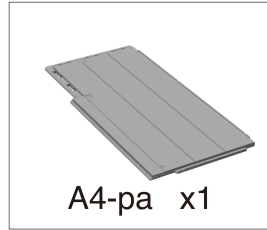
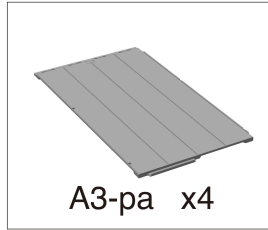
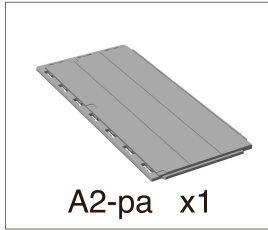
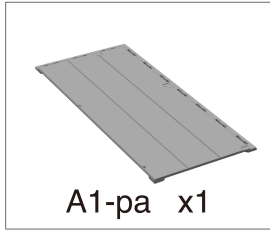
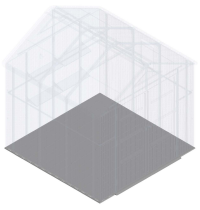
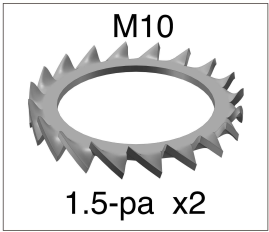
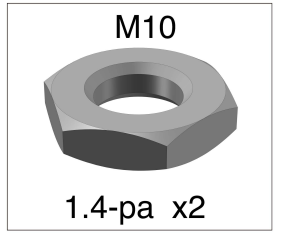
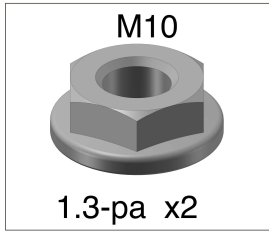
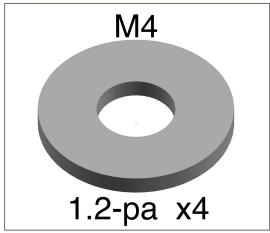
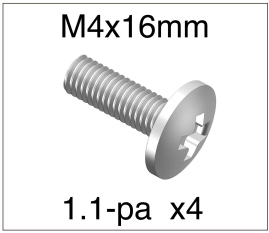
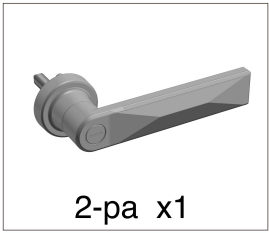
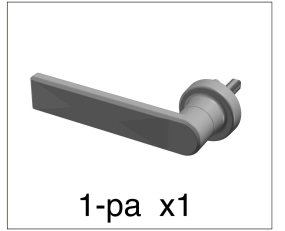
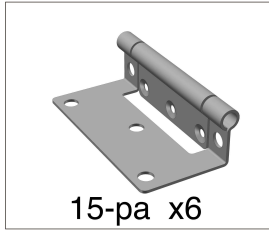
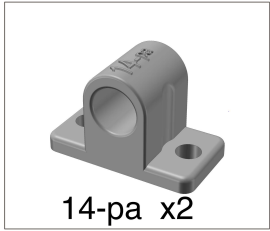
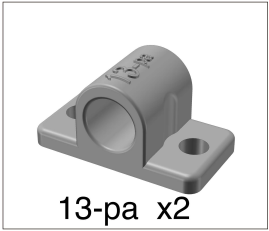
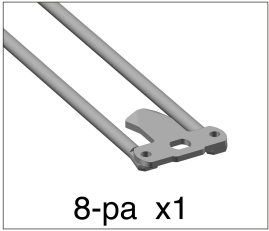
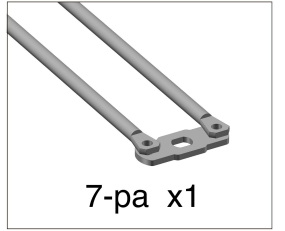
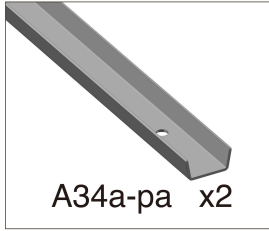
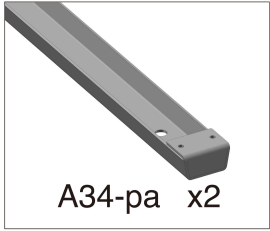
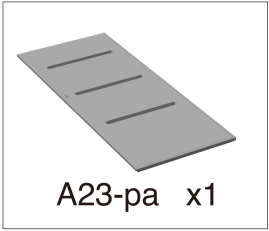
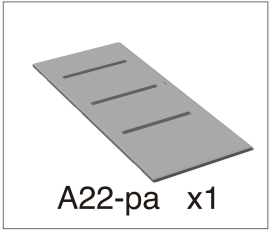
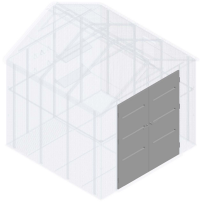
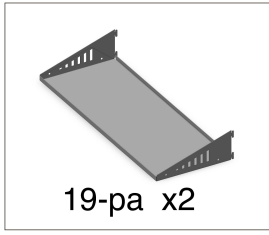
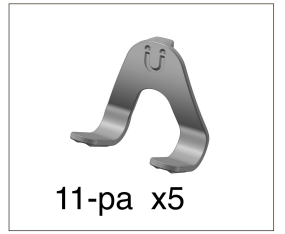
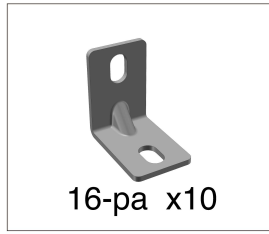
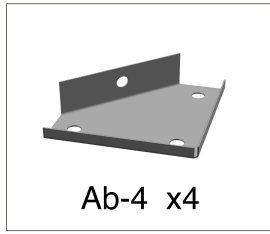
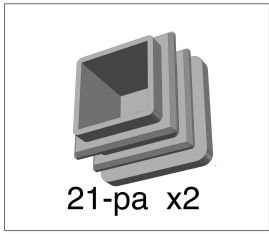
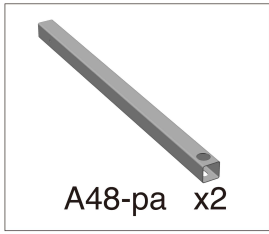

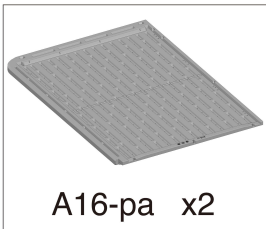
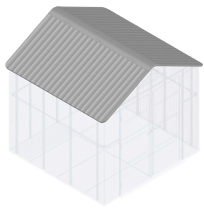

A16-pa x2

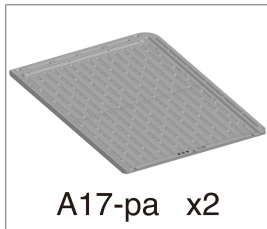

A17-pa x2

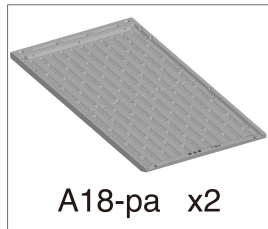

A18-pa x2



A44-pa x4



A45-pa x2



A19-pa x1

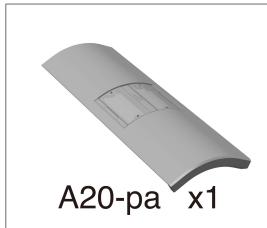

A20-pa x1

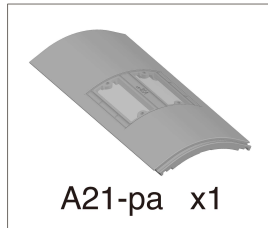

A21-pa x1



M4x10mm

B50-pa x18



ST4x12mm

B51-pa x44



ST4.2x13mm

B52-pa x4



M6x10mm

B53-pa x64



M6x18mm

B54-pa x39



M6x25mm

B55-pa x11

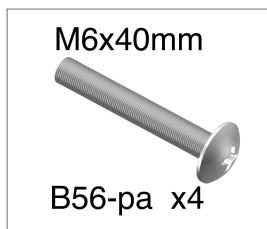

M6x40mm

B56-pa x4



ST6x12mm

B57-pa x20



ST6x16mm

B58-pa x97



ST6x20mm

B59-pa x54

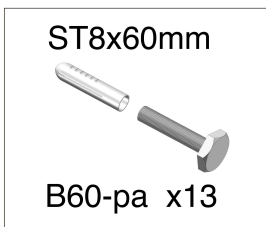

ST8x60mm

B60-pa x13

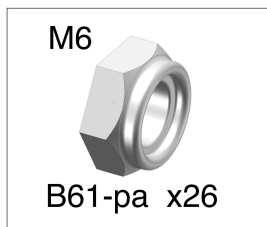

M6

B61-pa x26

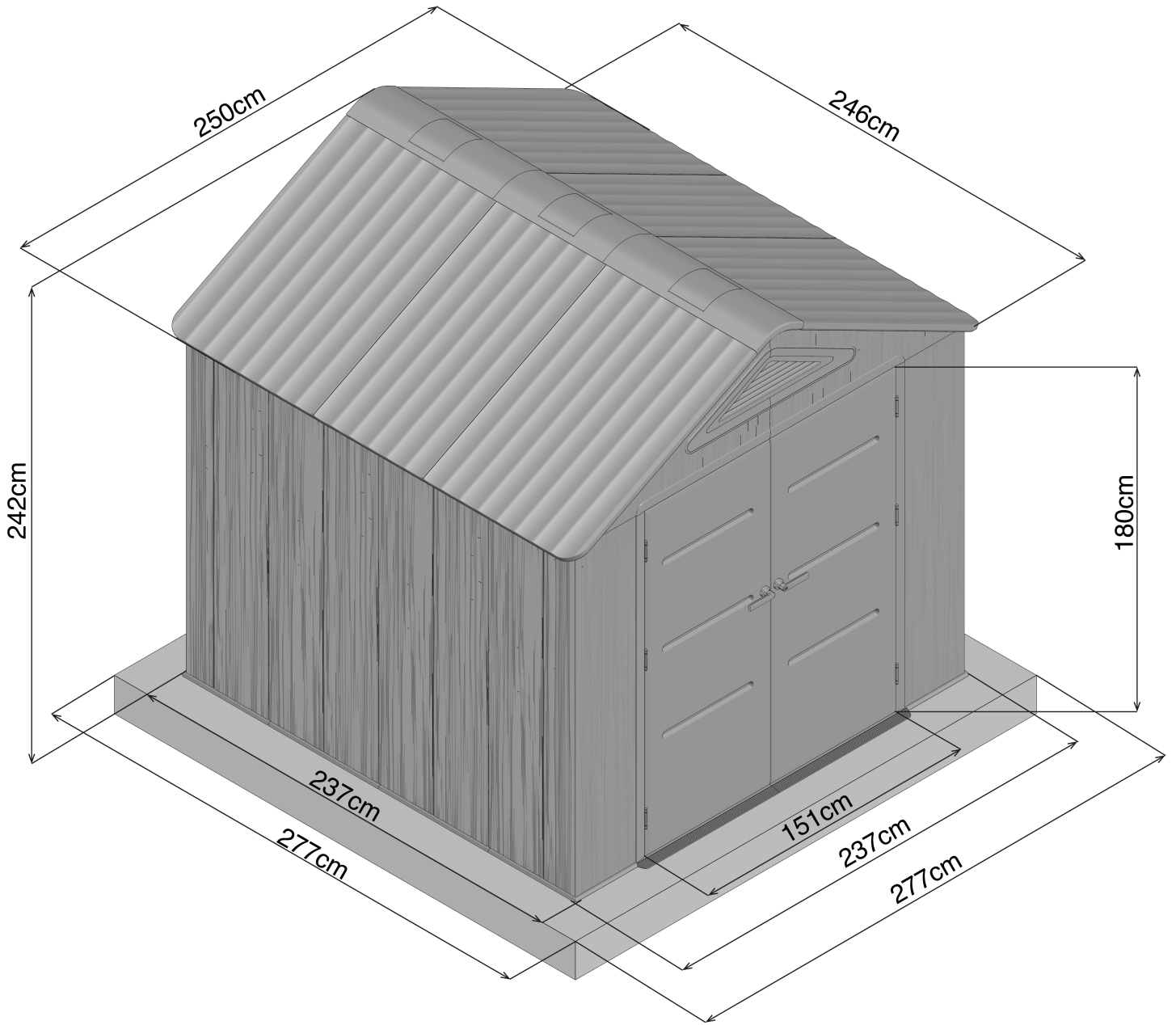

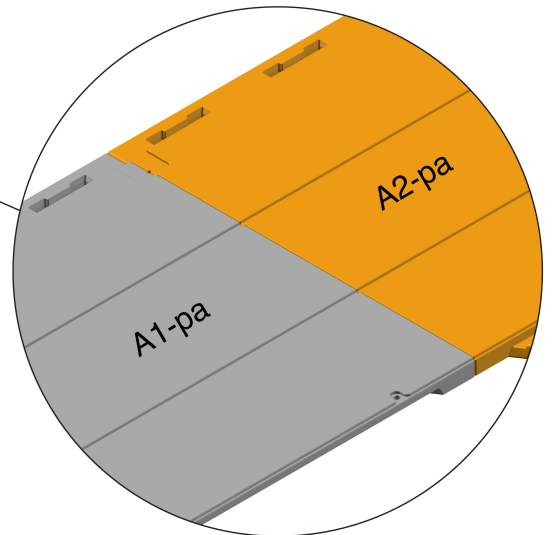
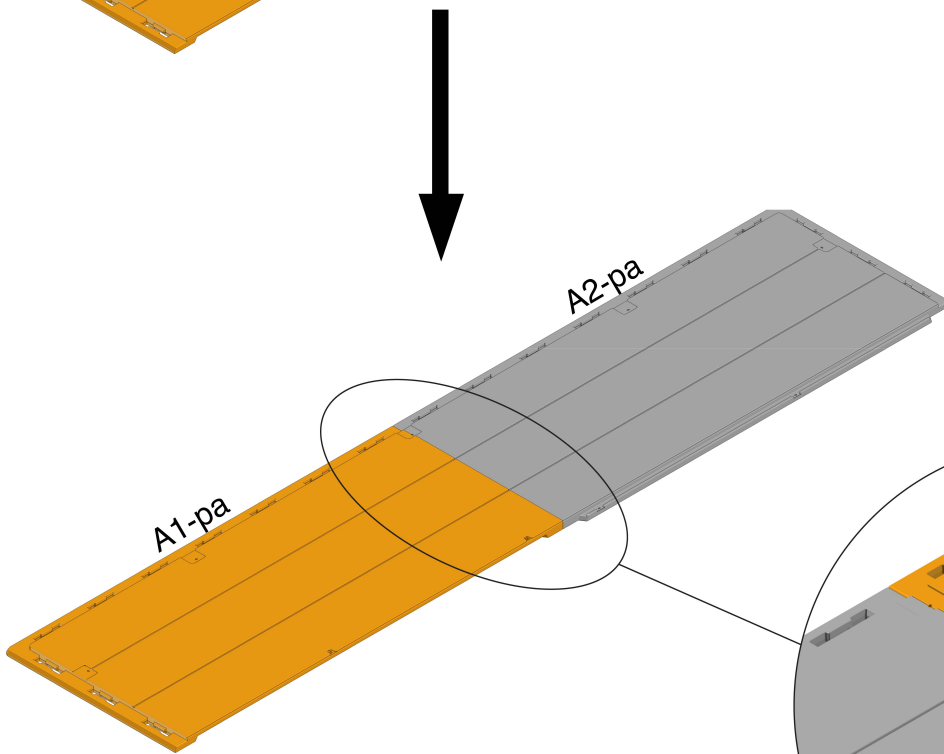
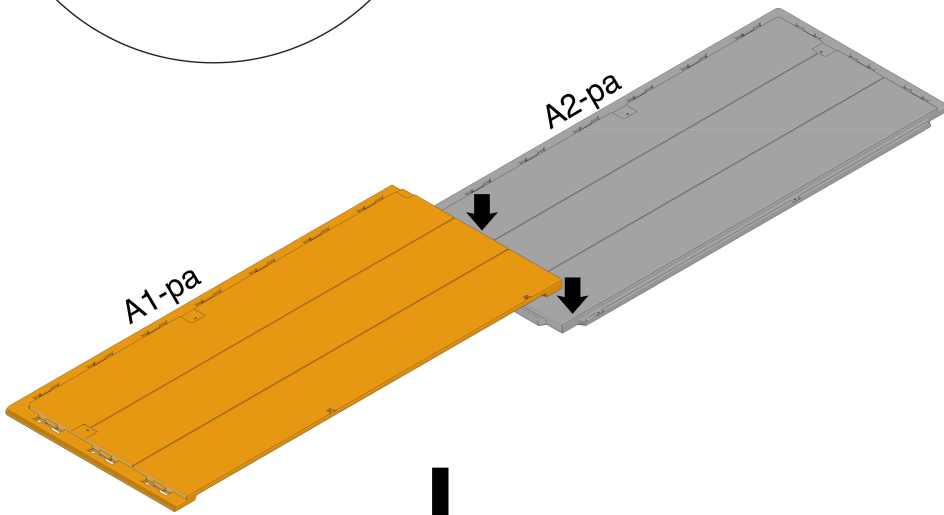
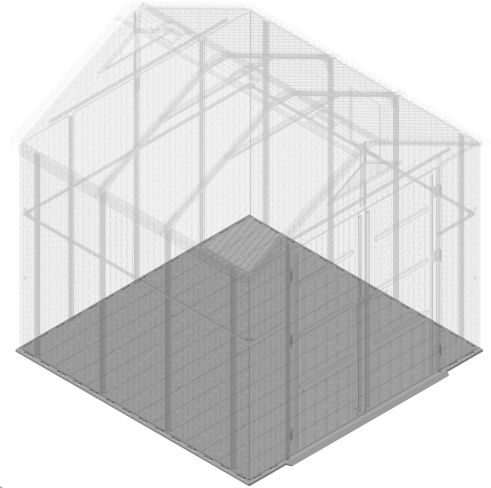
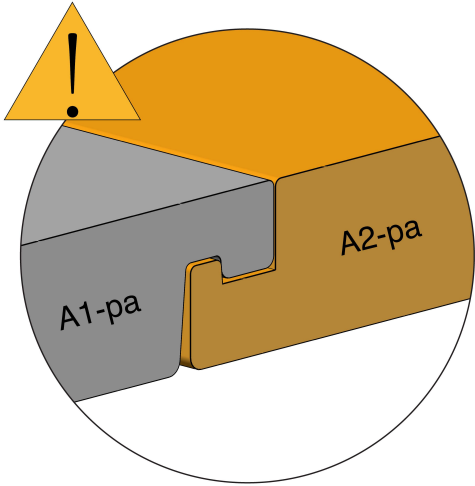
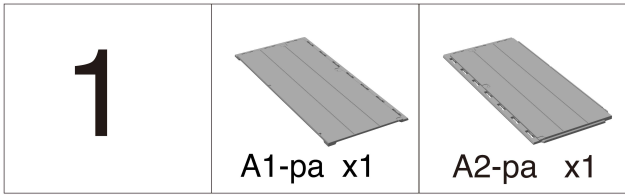

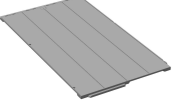
2	 A3-pa x2
---	---

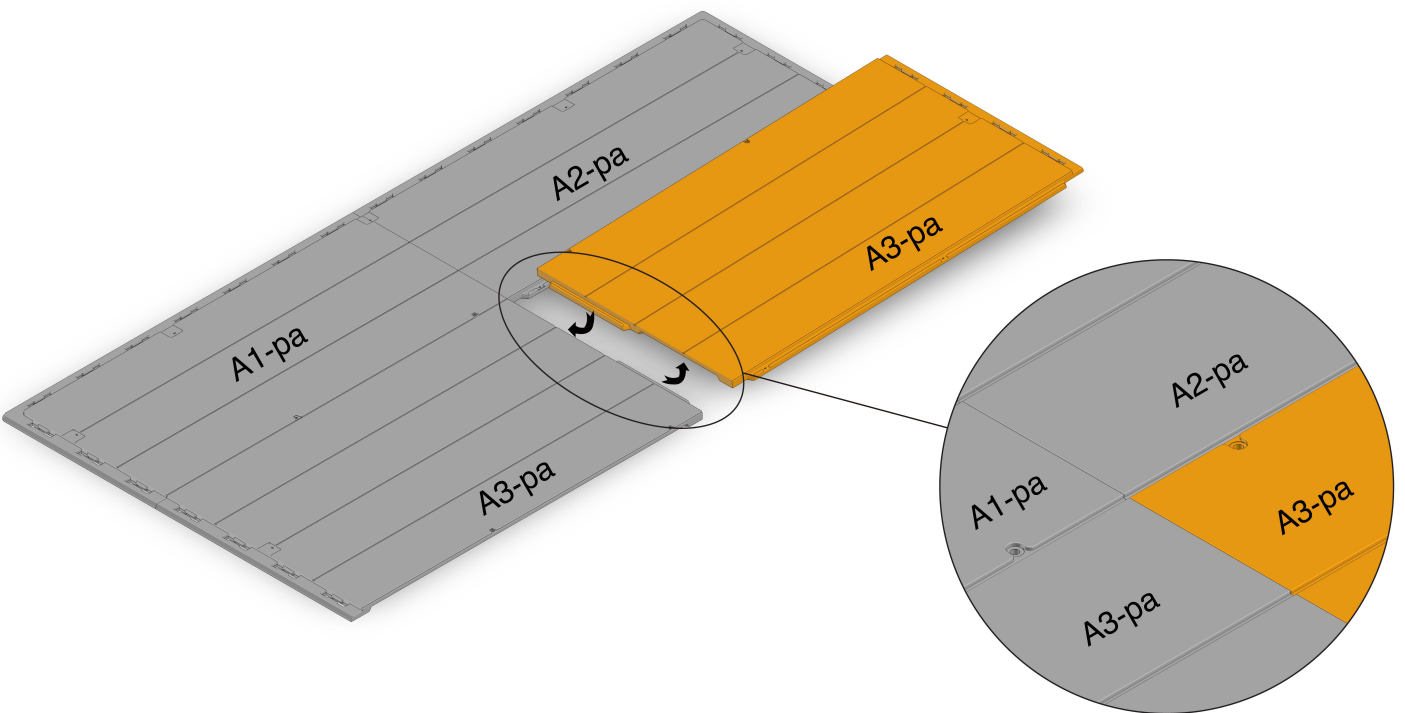
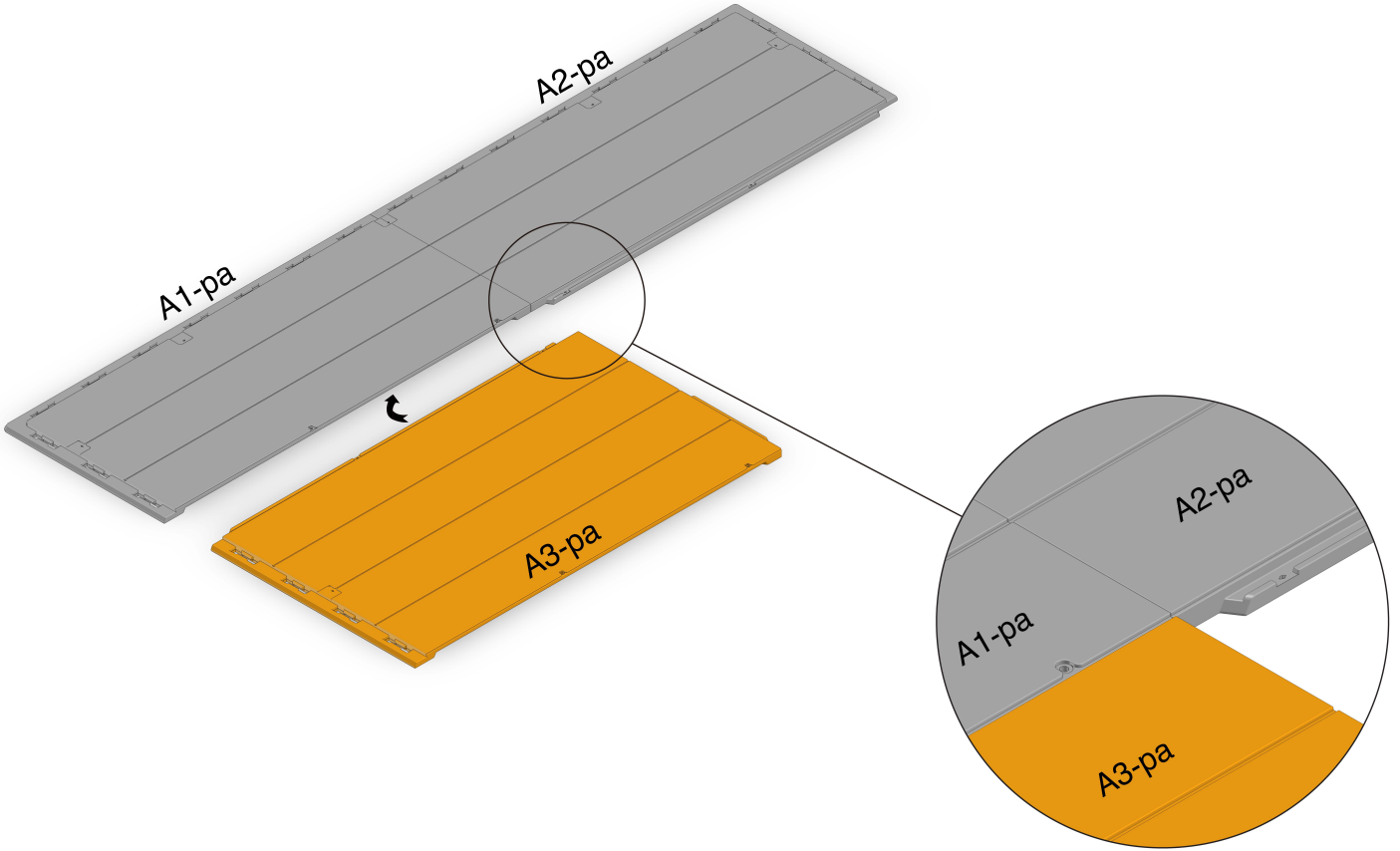

3

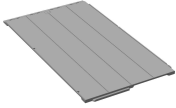

A3-pa x2

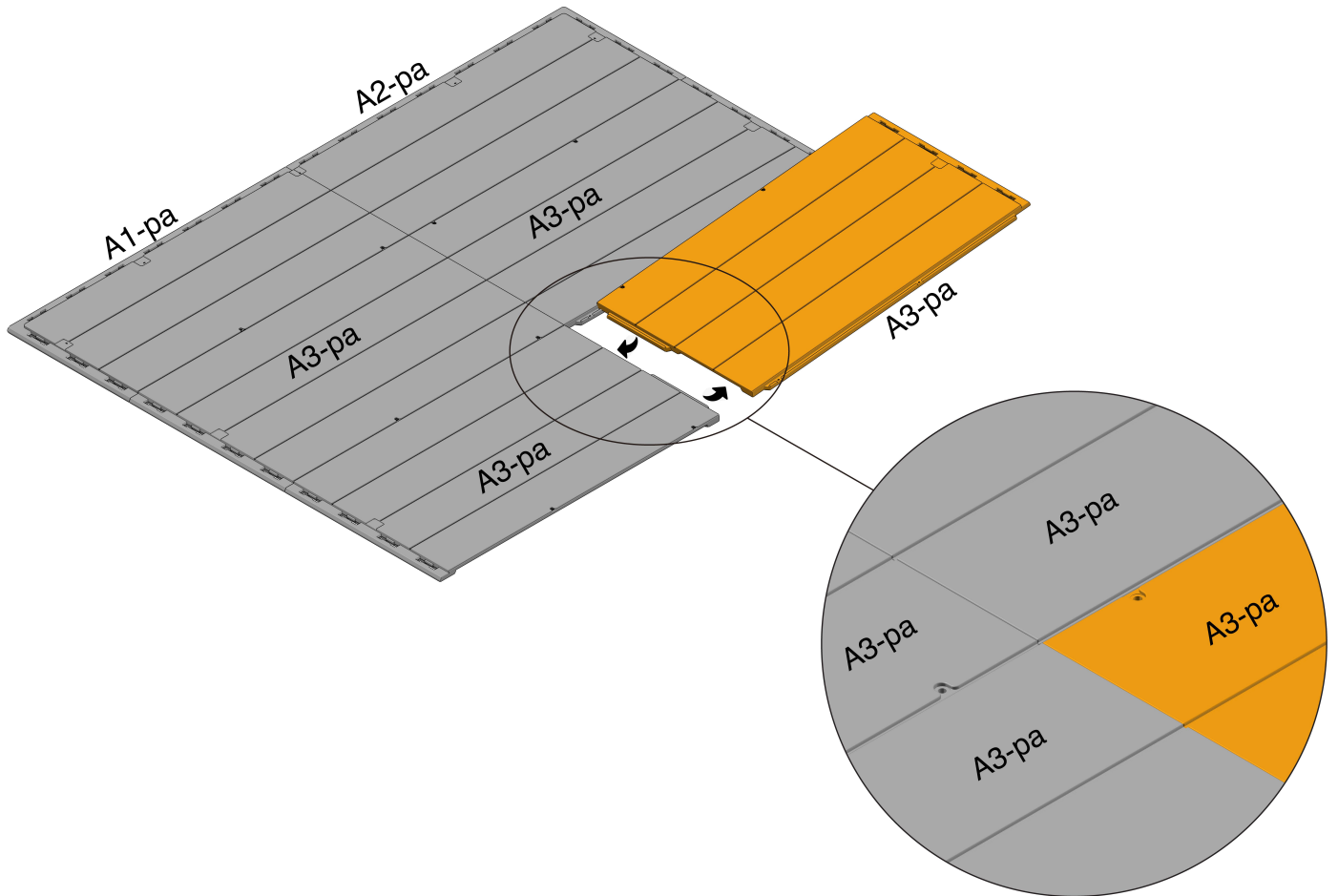
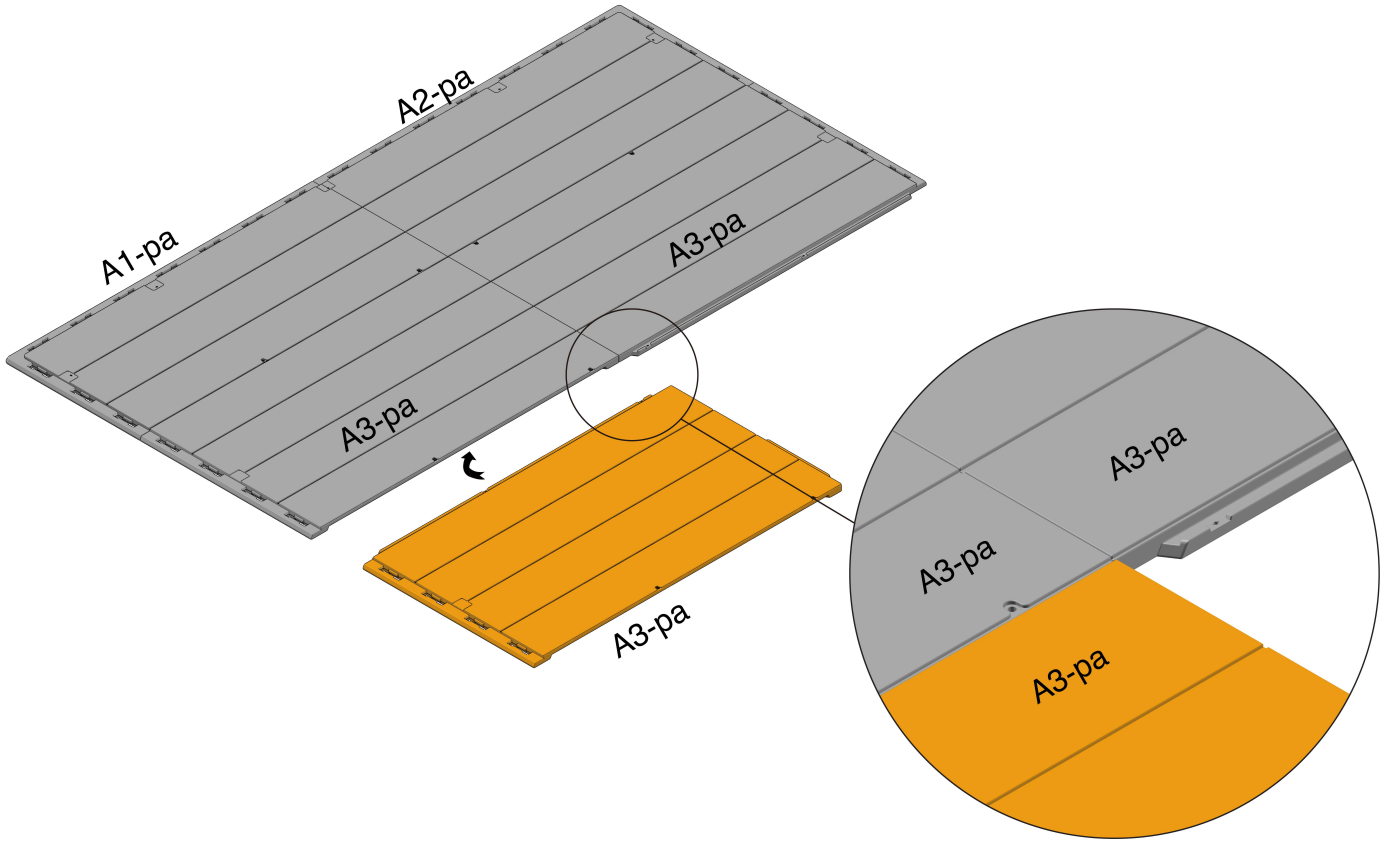

4

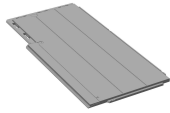

A4-pa x1

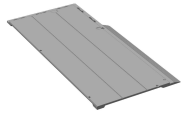

A5-pa x1



B58-pa x13

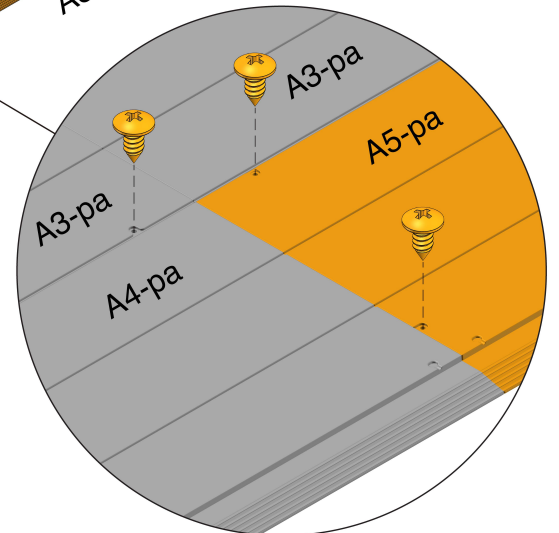
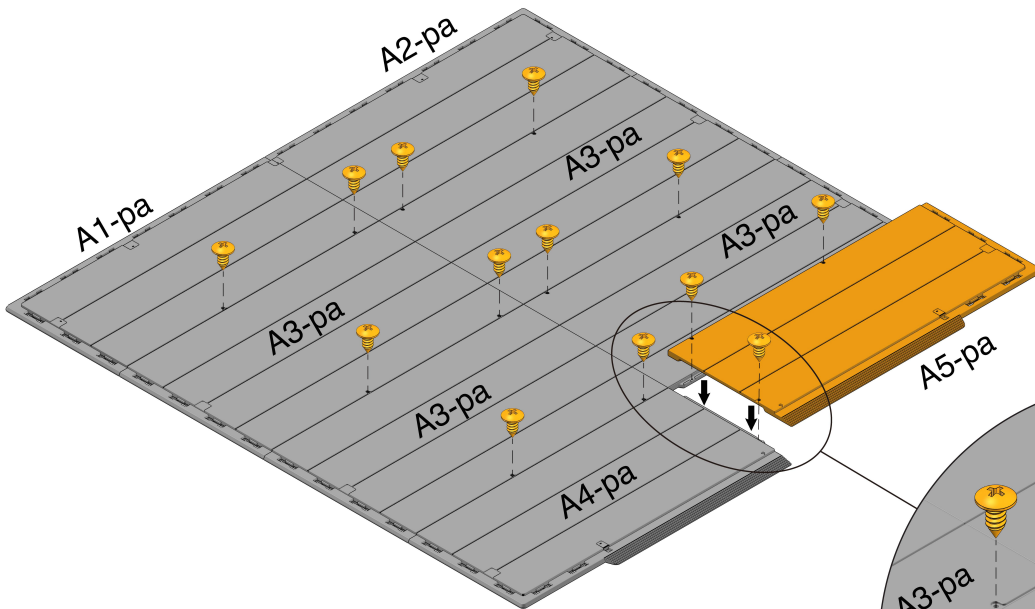
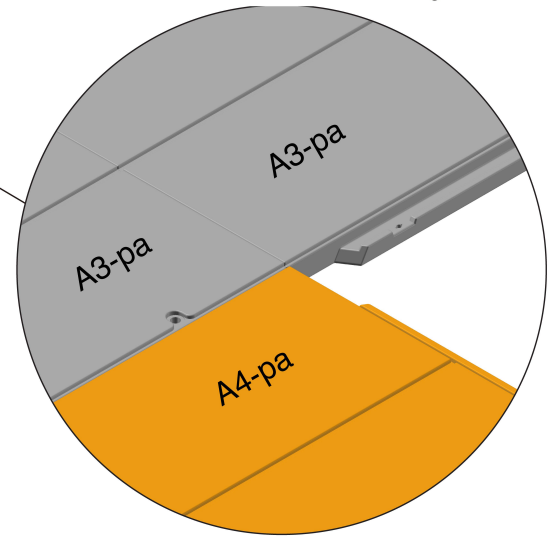
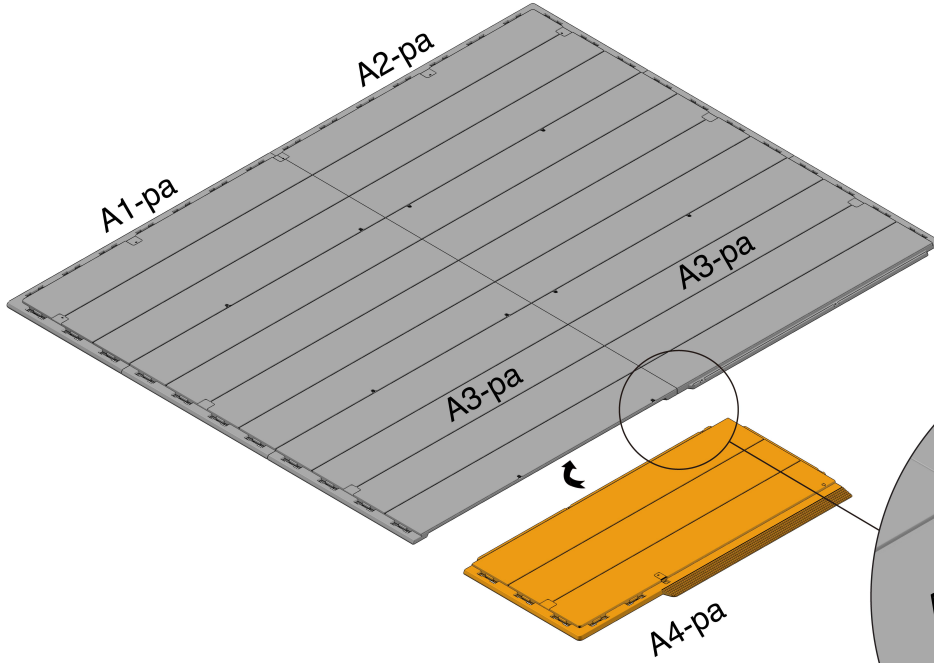
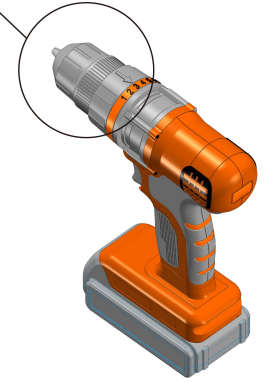
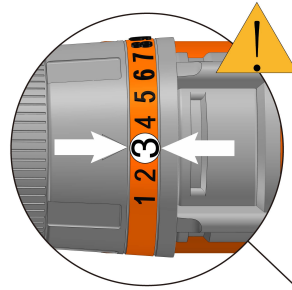

5

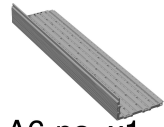

A6-pa x1

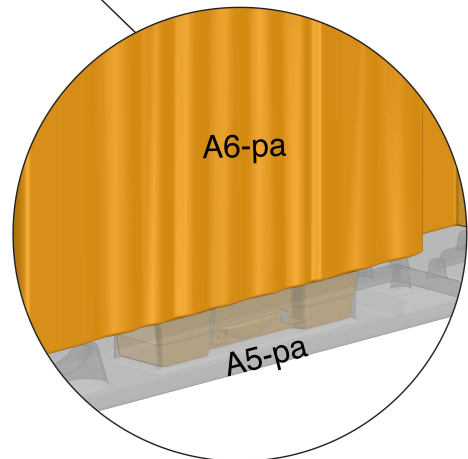
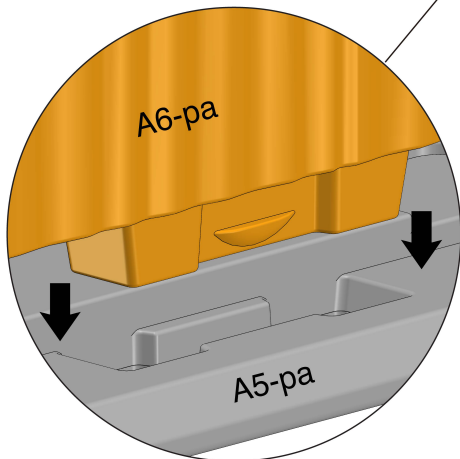
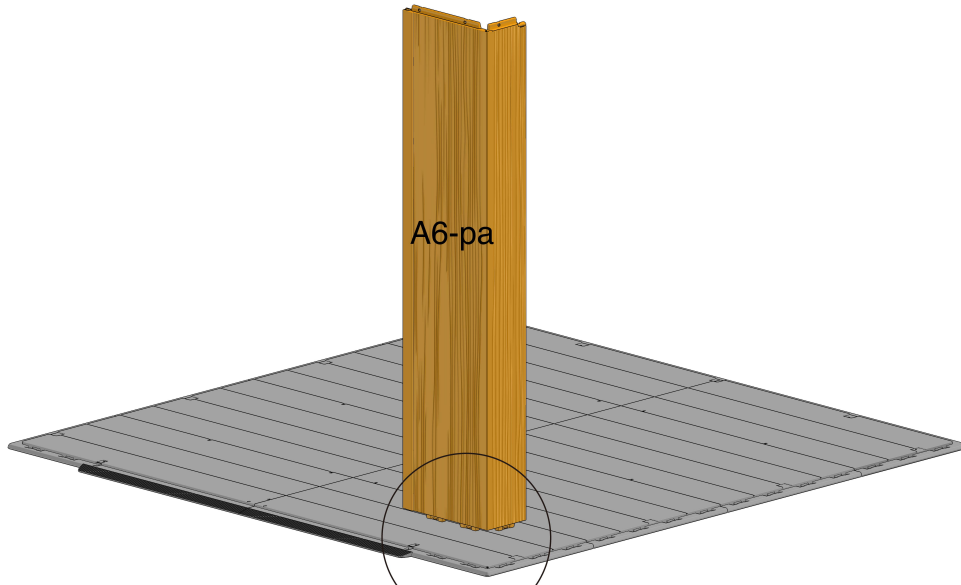
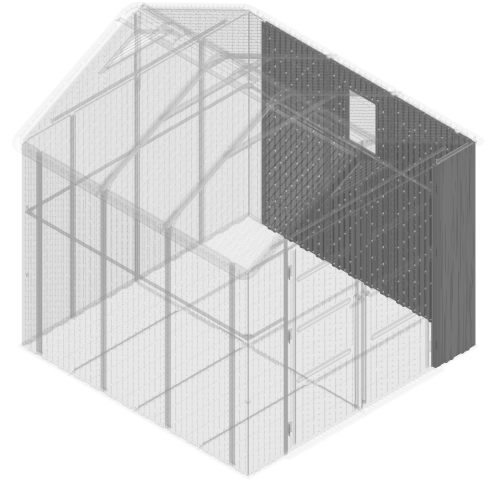
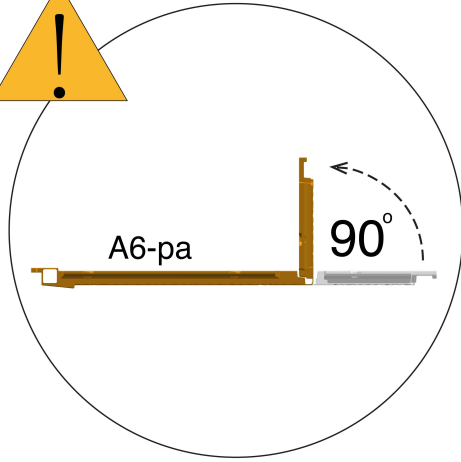

6

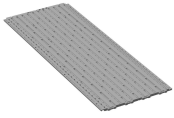

A7-pa x1

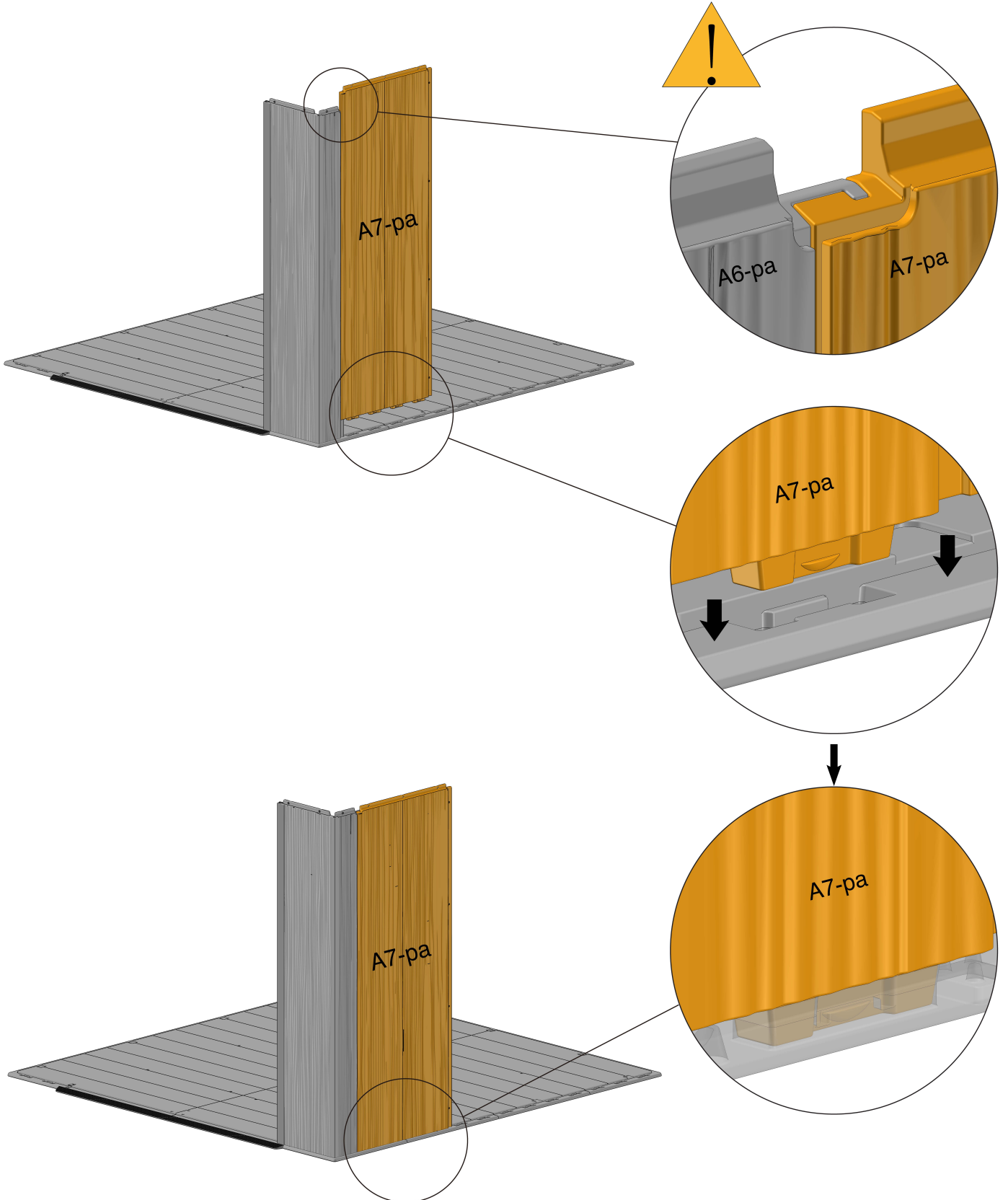

7

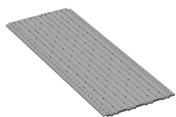

A7-pa x1

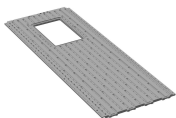

A8-pa x1

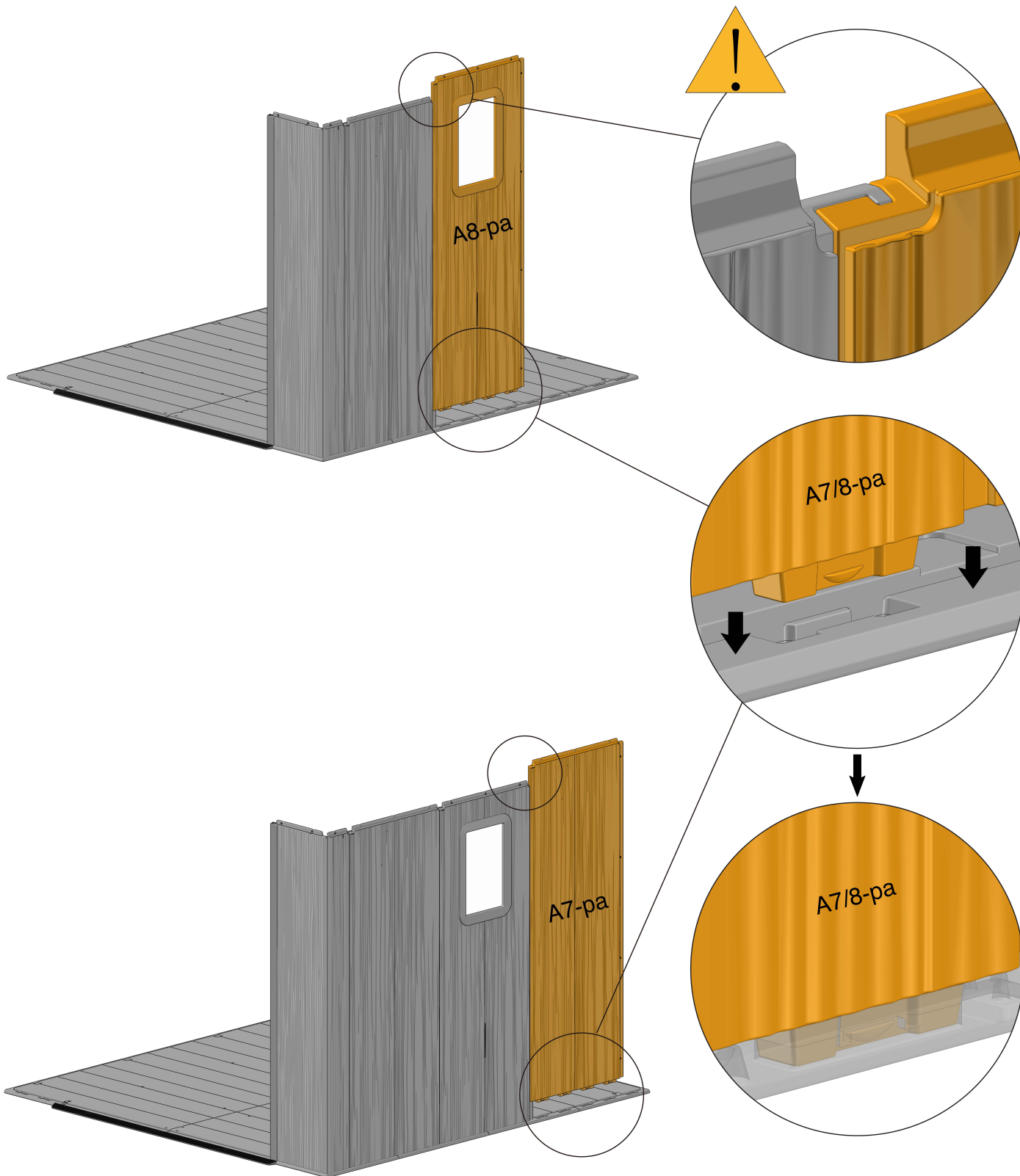

8

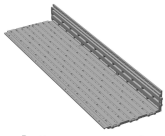

A9-pa x1

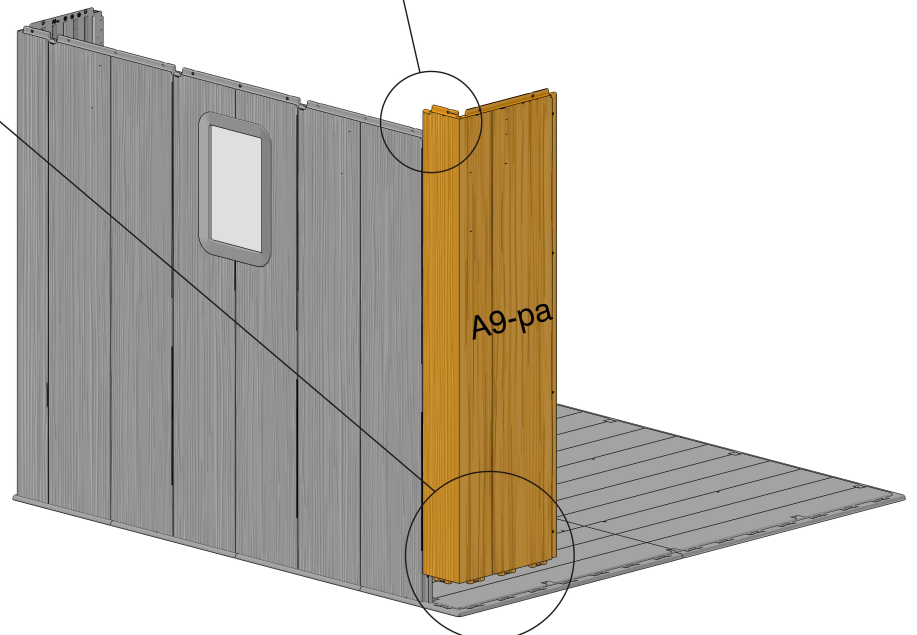
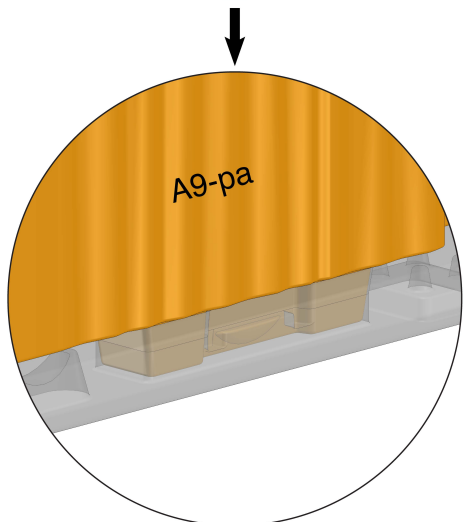
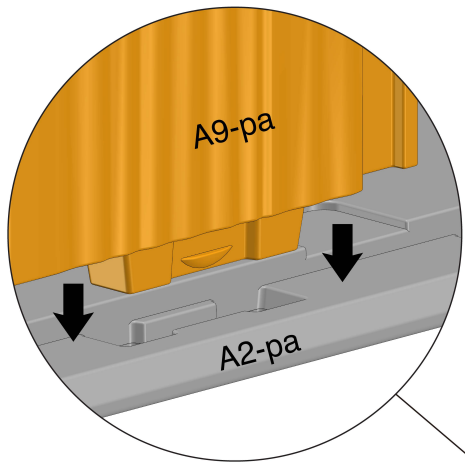
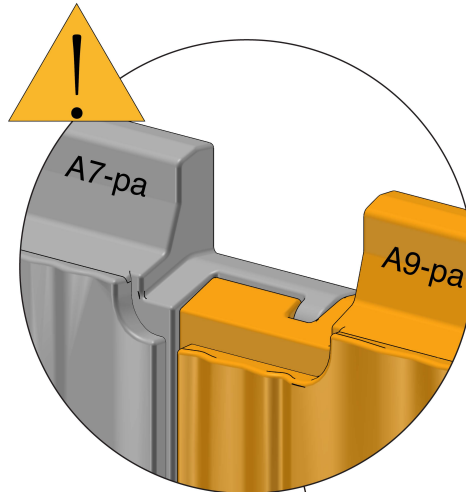
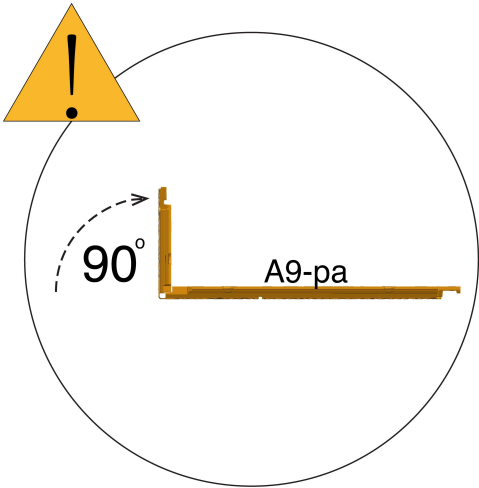
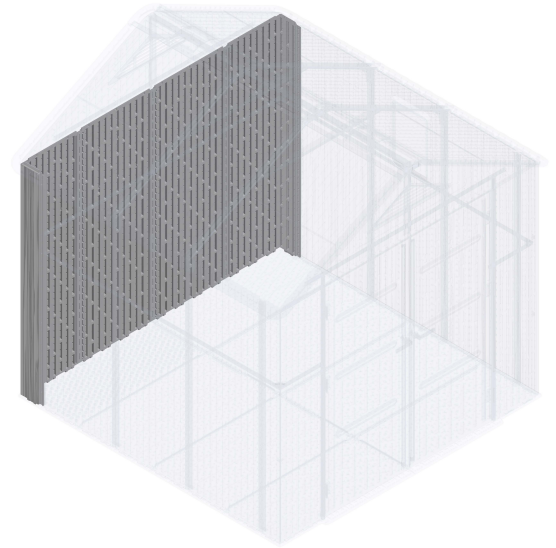

9

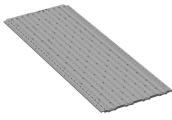

A7-pa x2

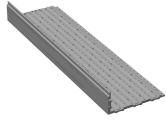

A10-pa x1

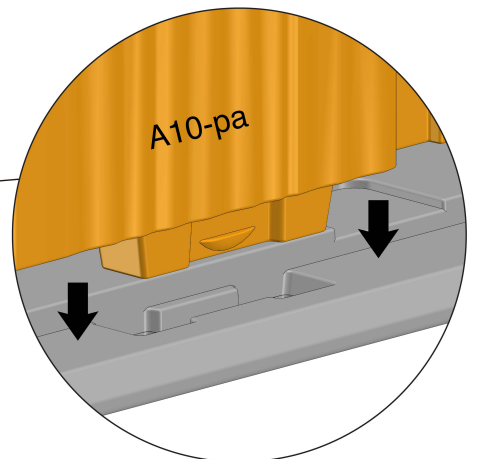
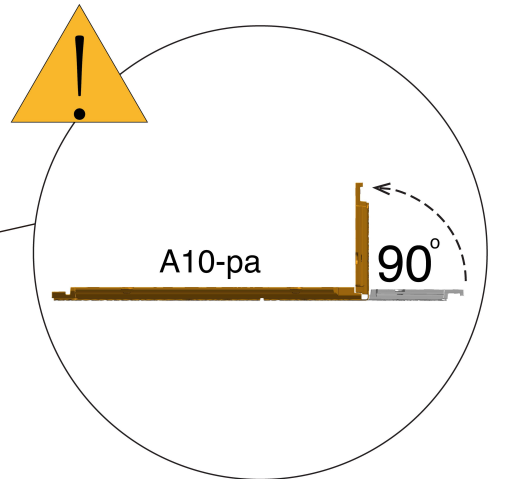
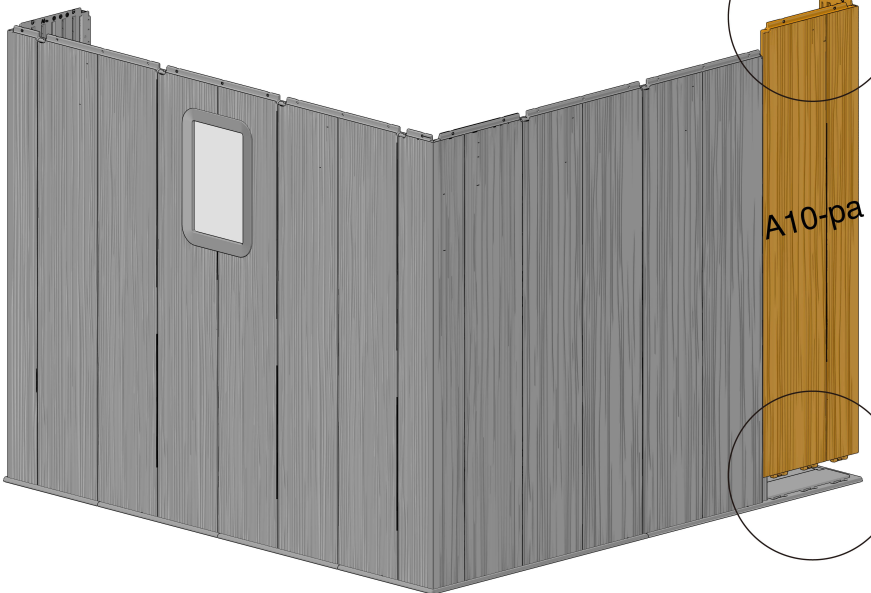
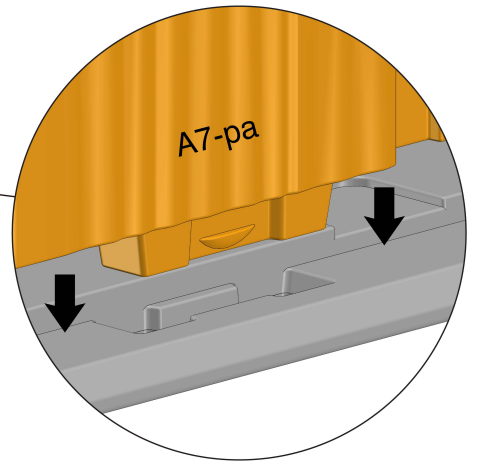
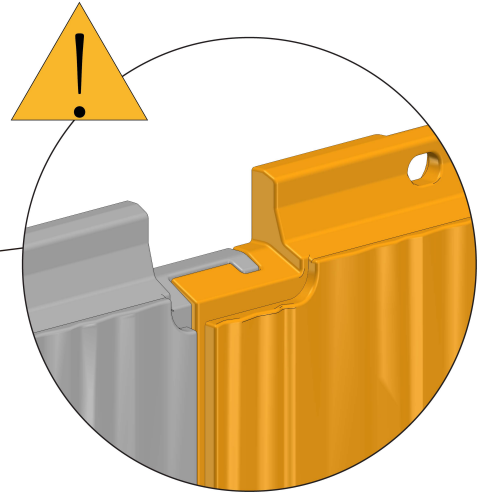
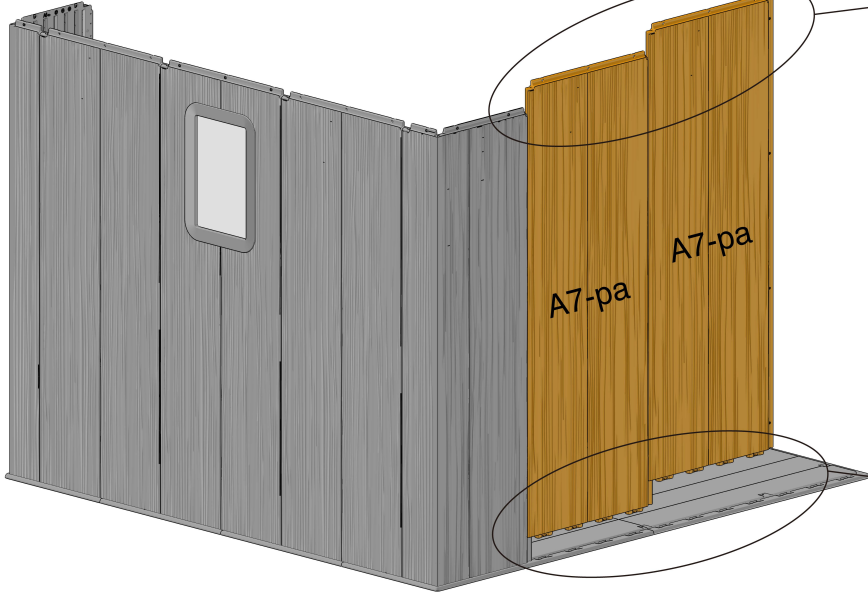

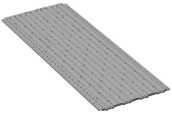
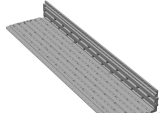
<h1>10</h1>	 <p>A7-pa x3</p>	 <p>A11-pa x1</p>
-------------	--	---

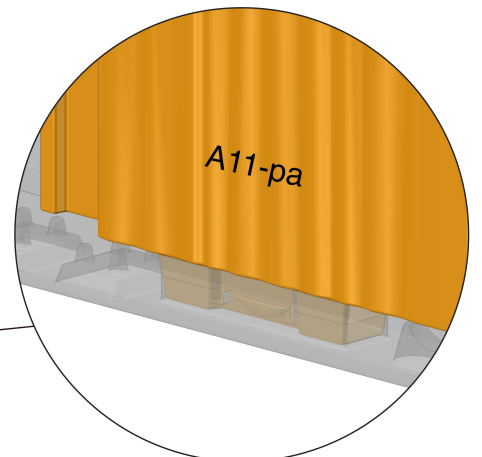
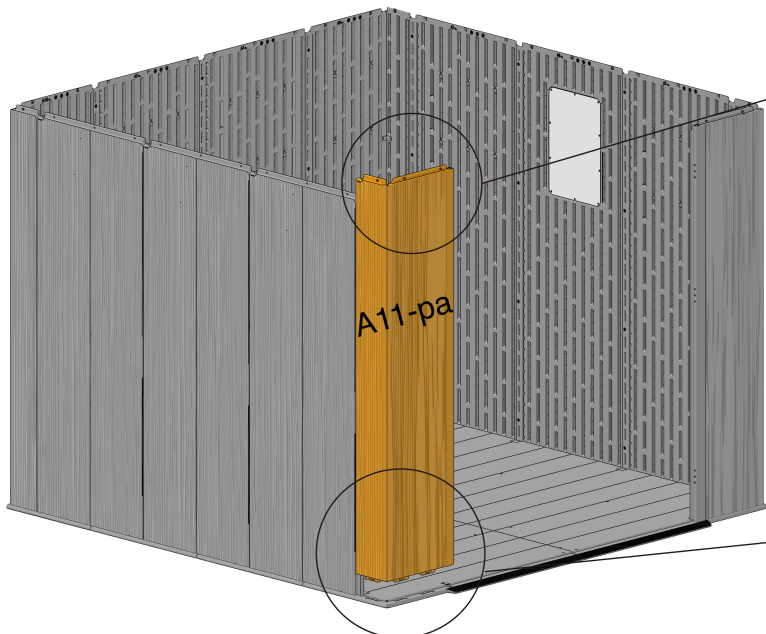
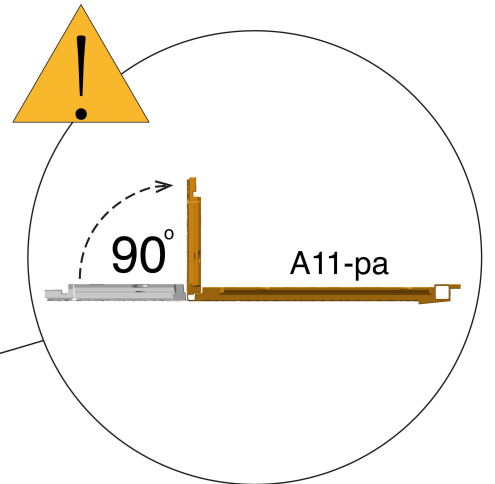
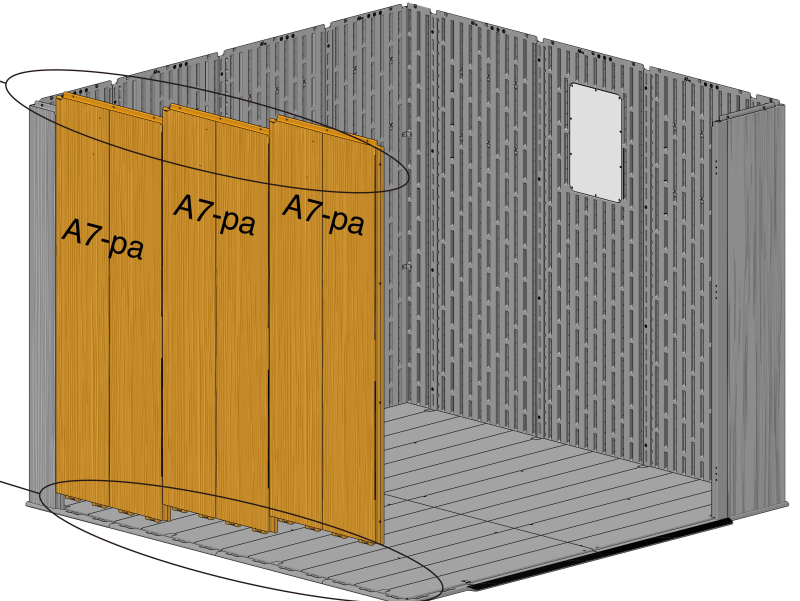
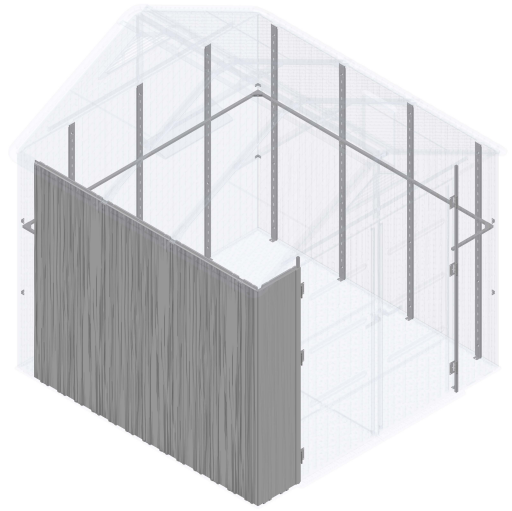
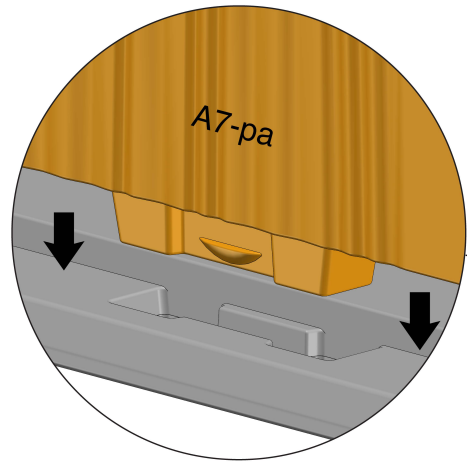
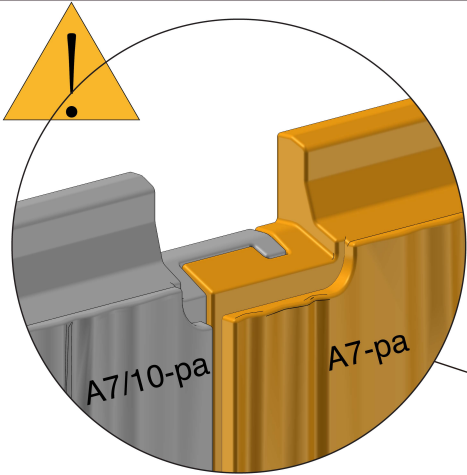

11

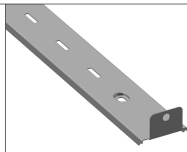

A30-pa x7



B54-pa x21

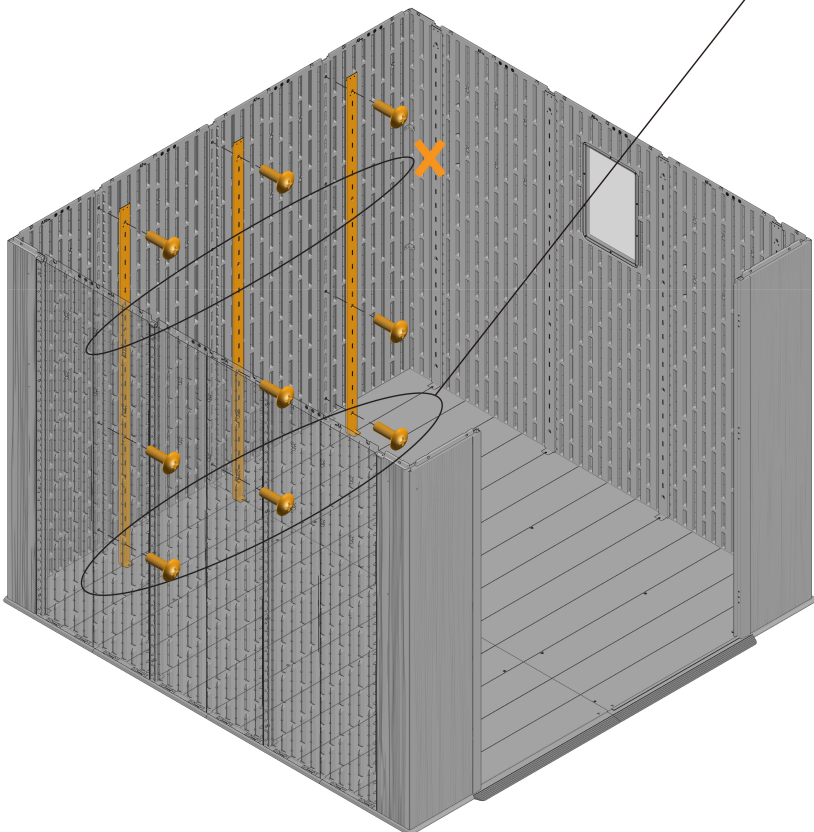
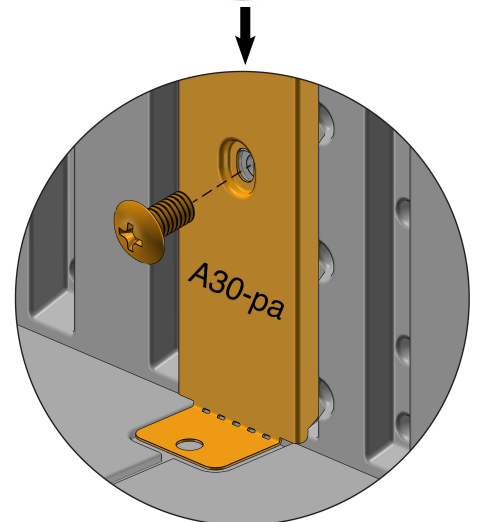
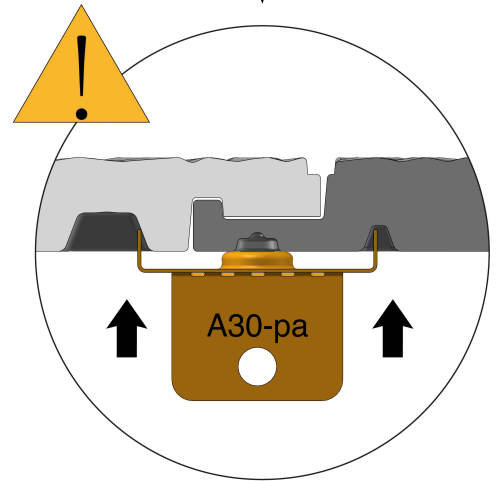
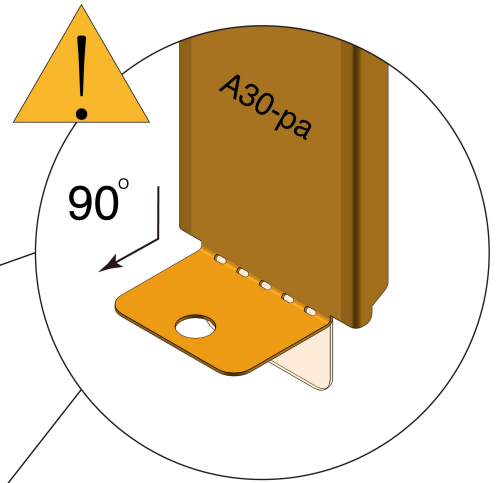
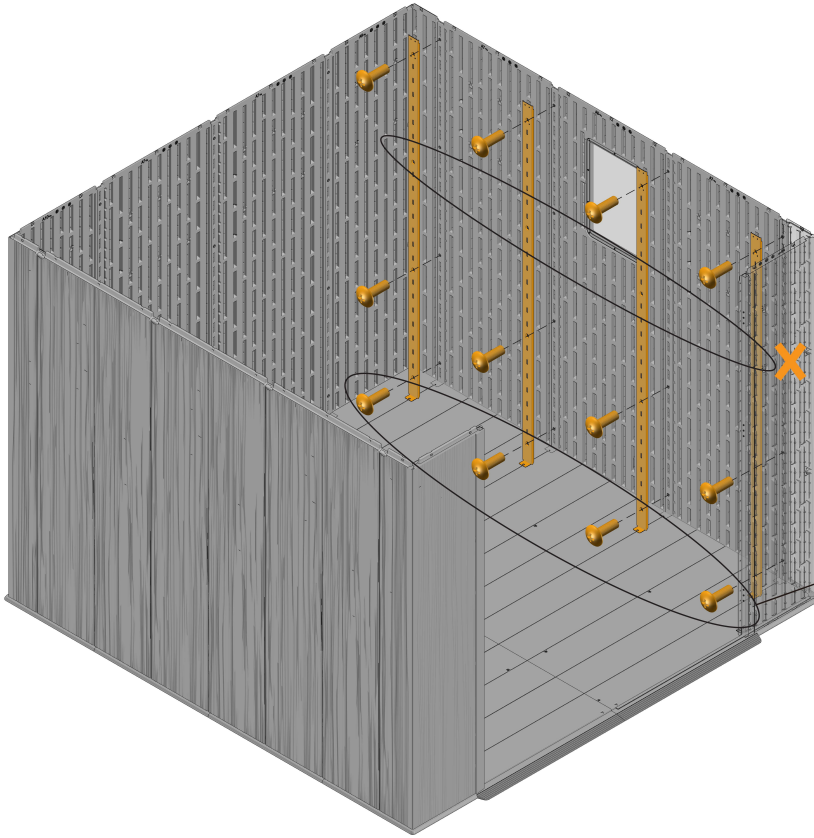

12

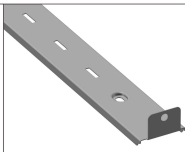

A30-pa x4



B54-pa x12

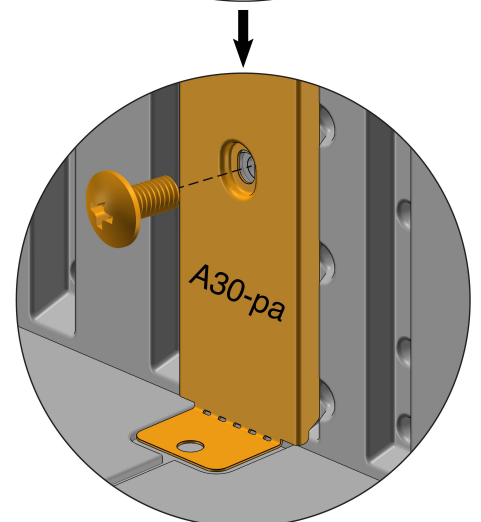
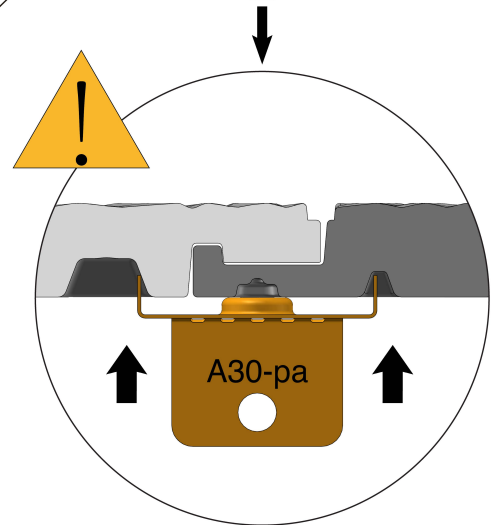
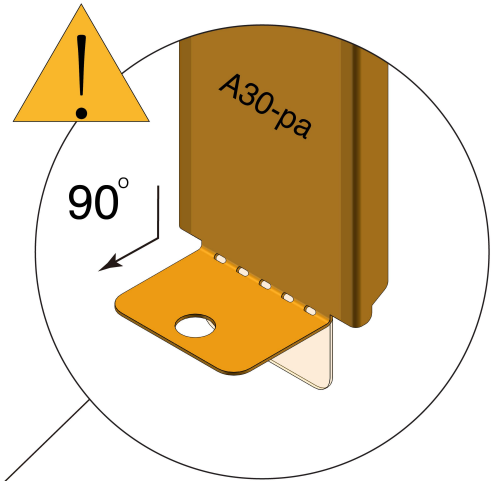
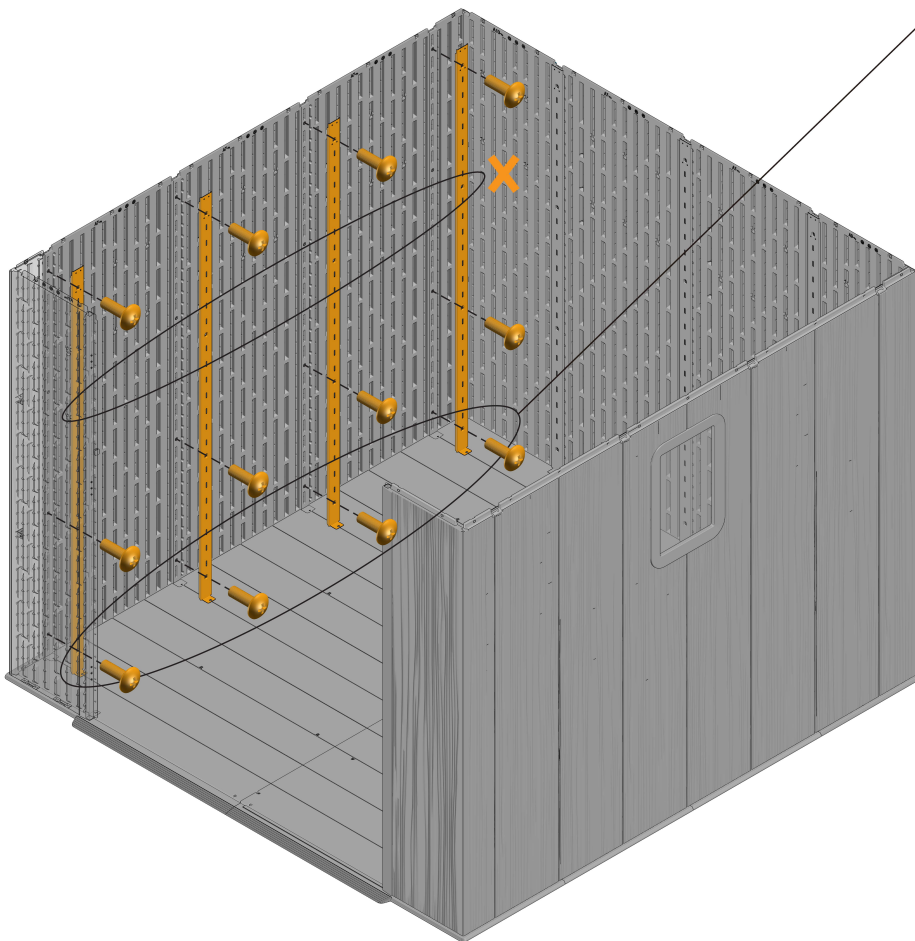

13

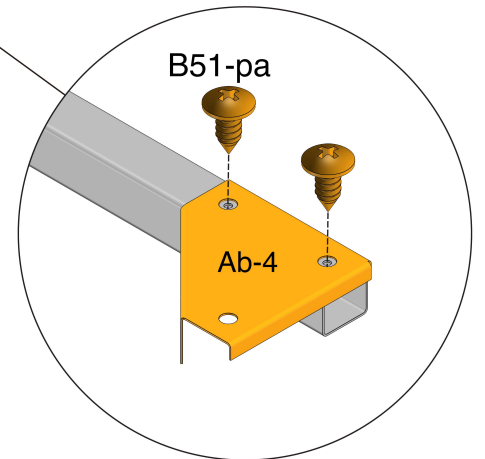
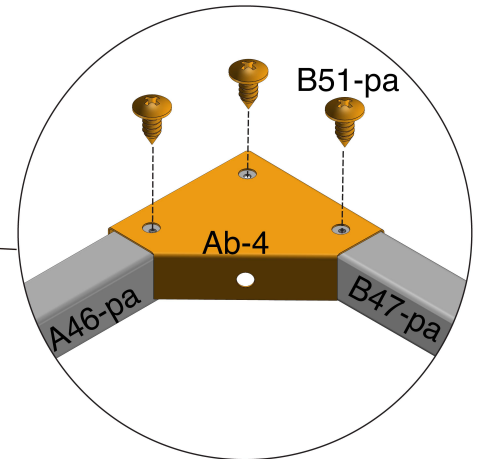
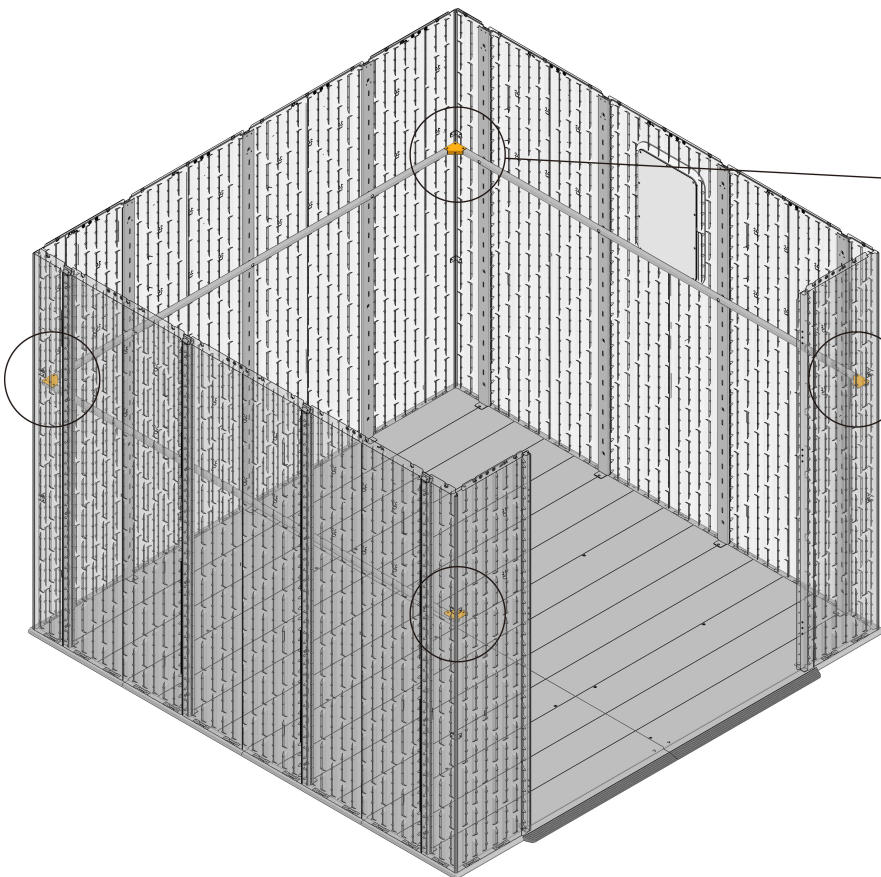
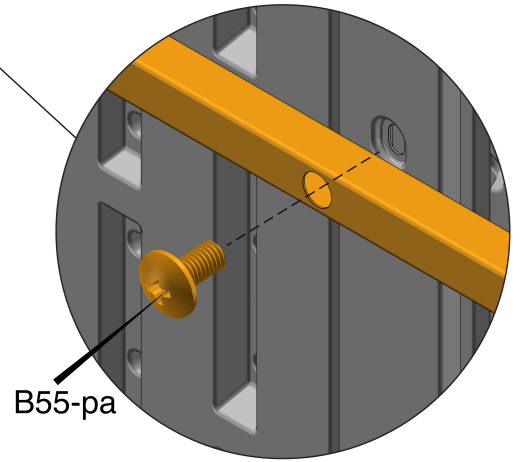
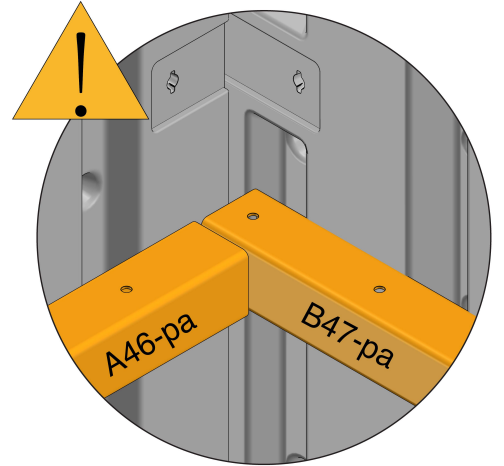
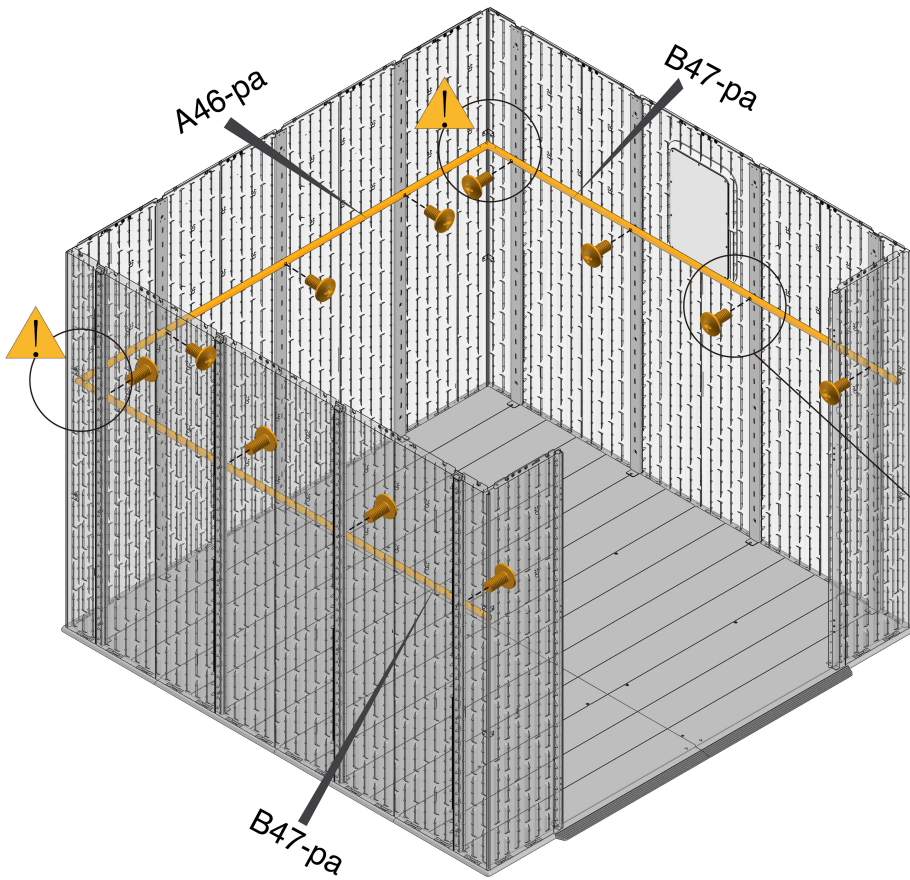
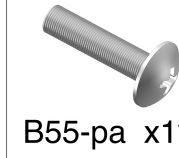
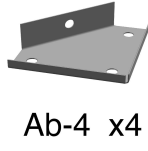
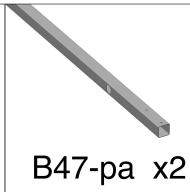
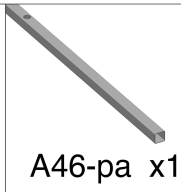

14



A33a-pa x1

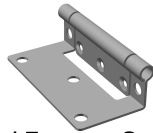

15-pa x3

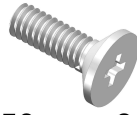

B50-pa x9

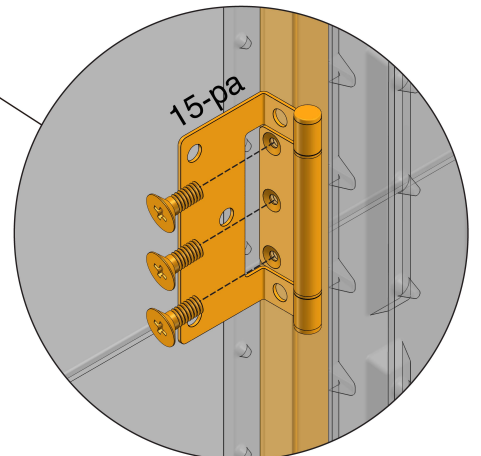
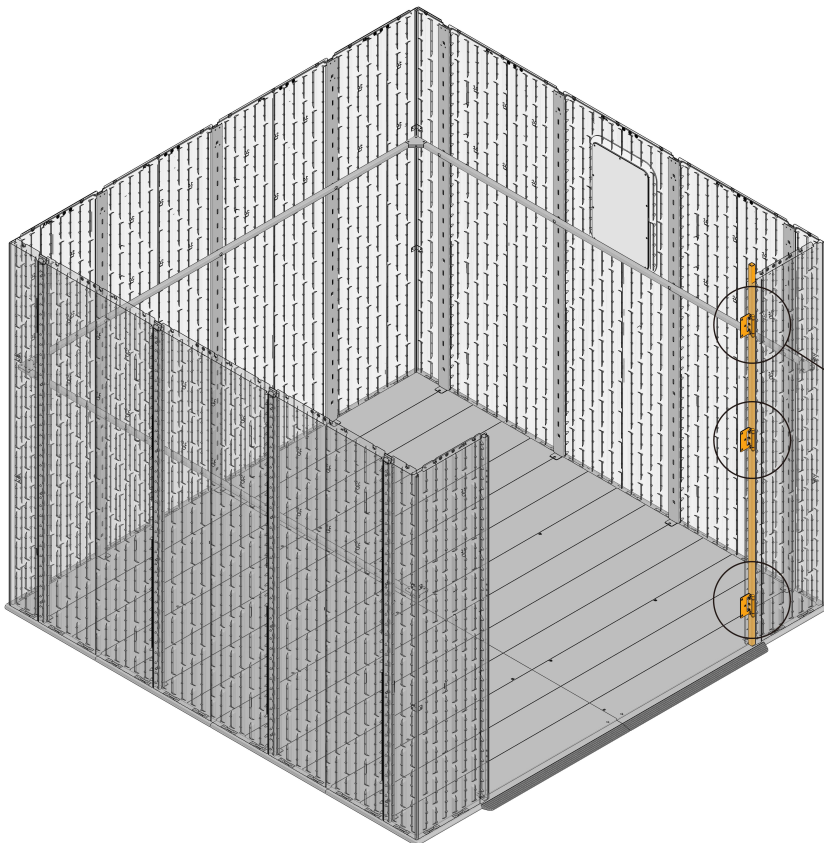
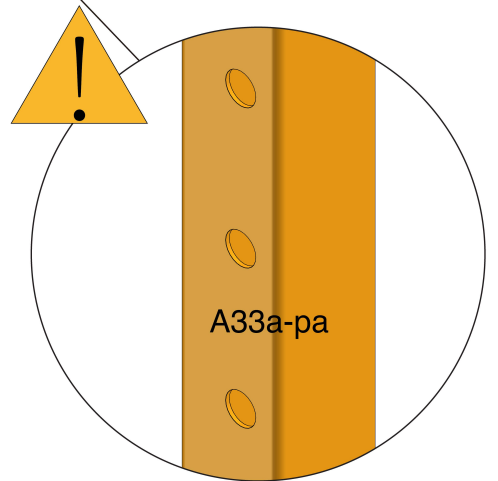
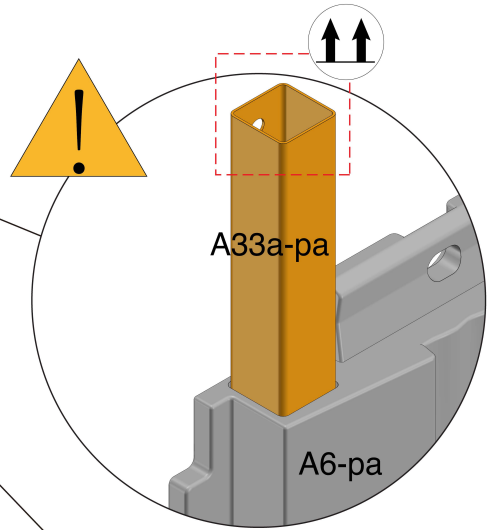
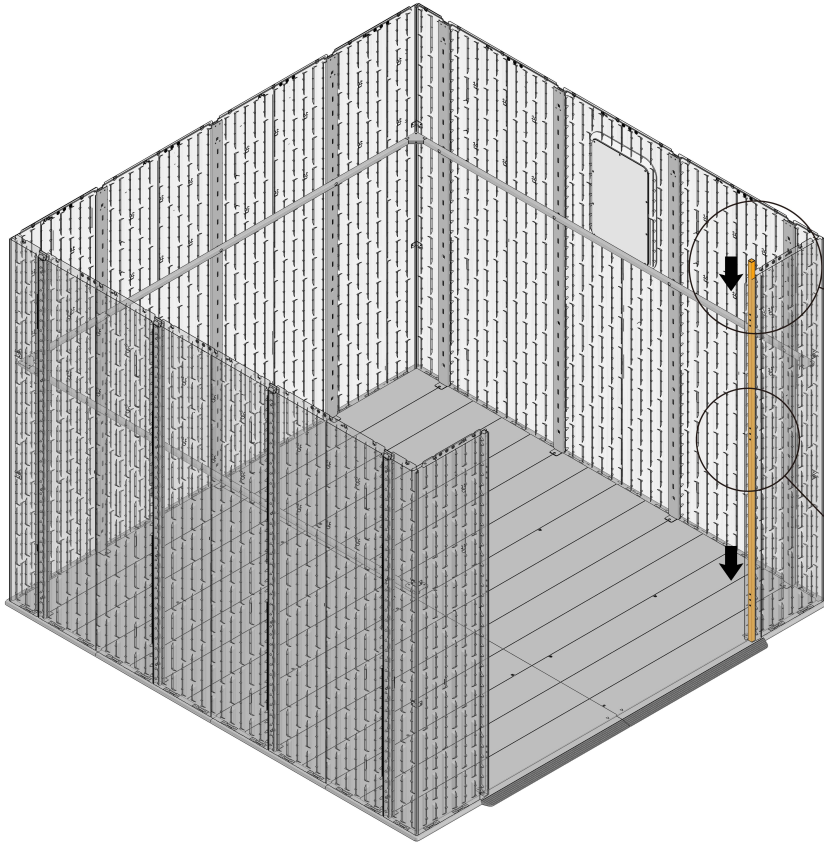

15

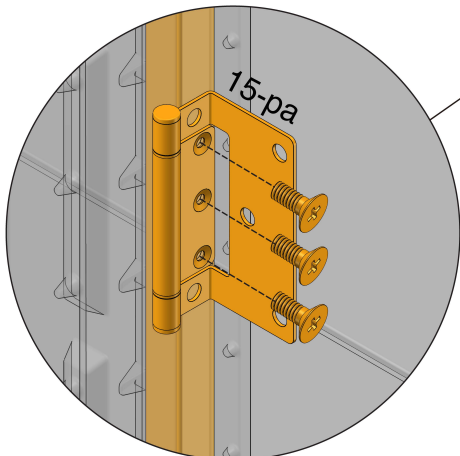
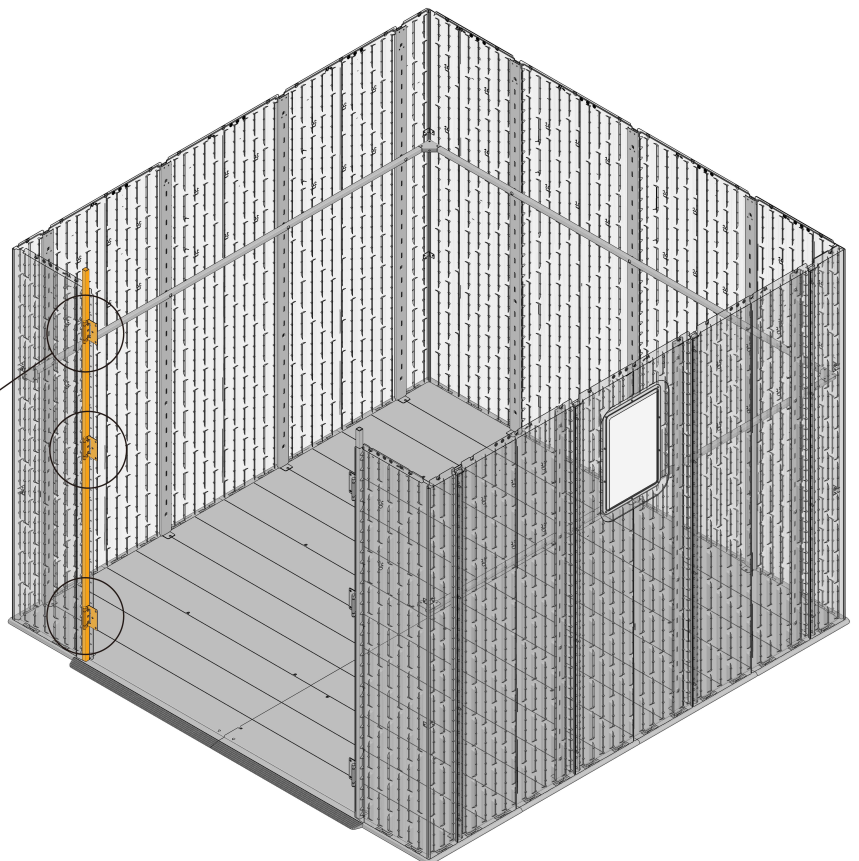
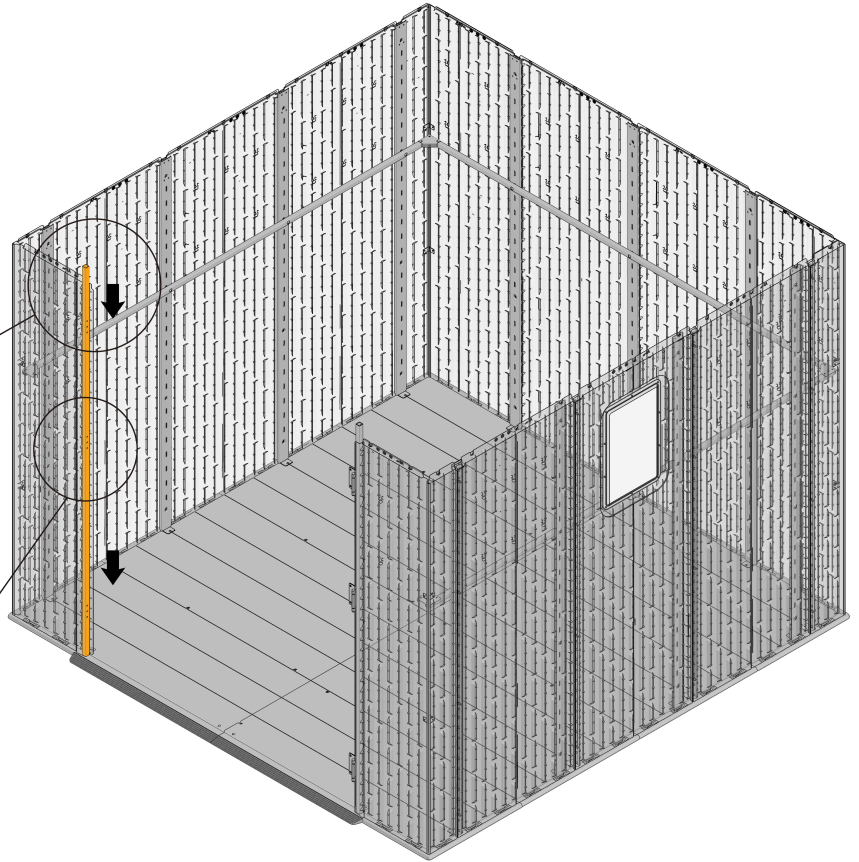
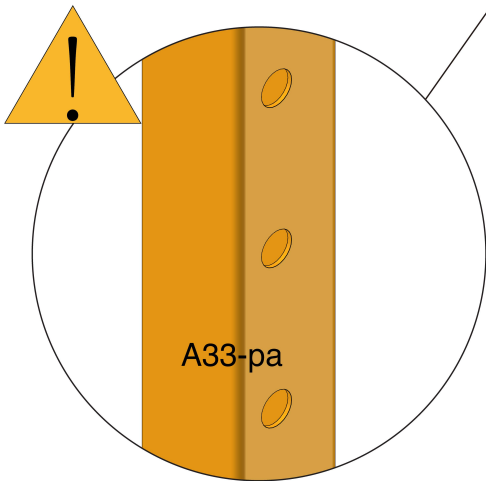
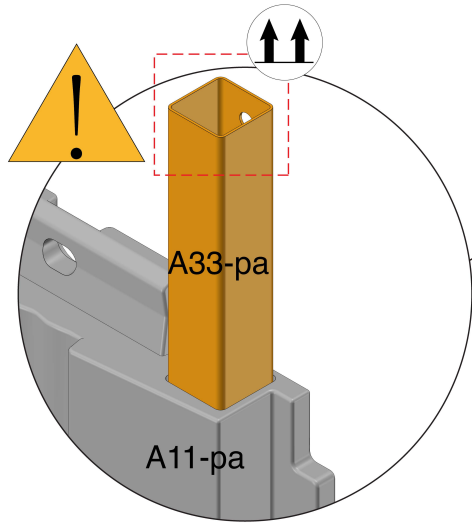
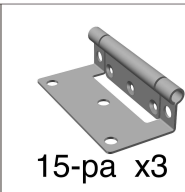
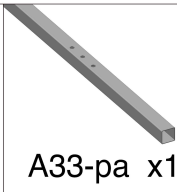

16



A48-pa x2

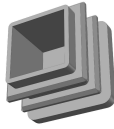

21-pa x2



16-pa x10



B51-pa x2



B52-pa x4



B58-pa x16

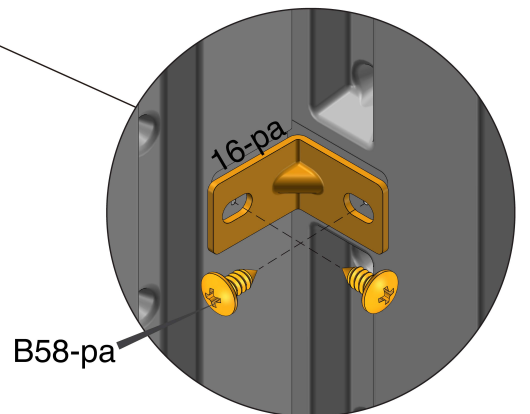
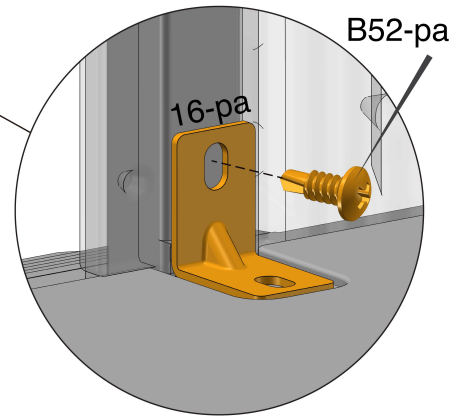
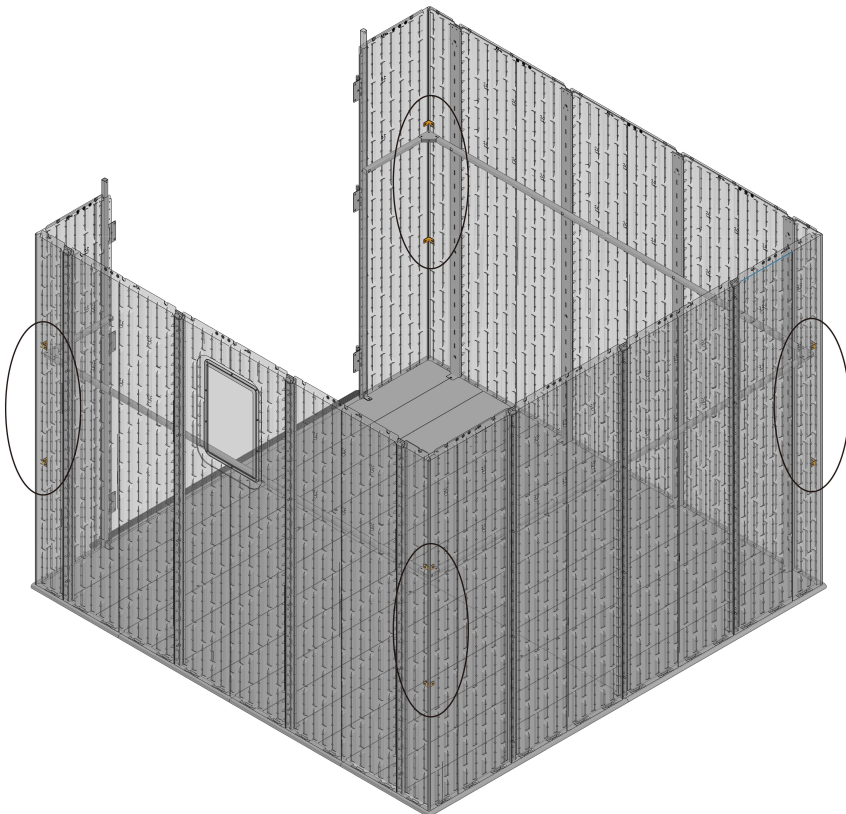
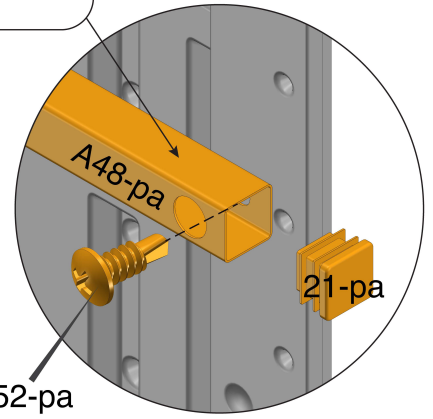
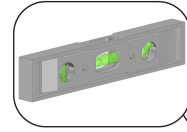
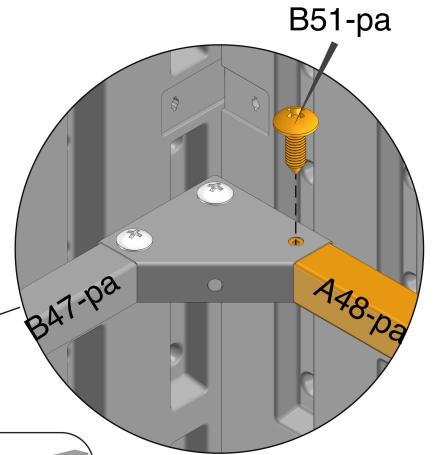
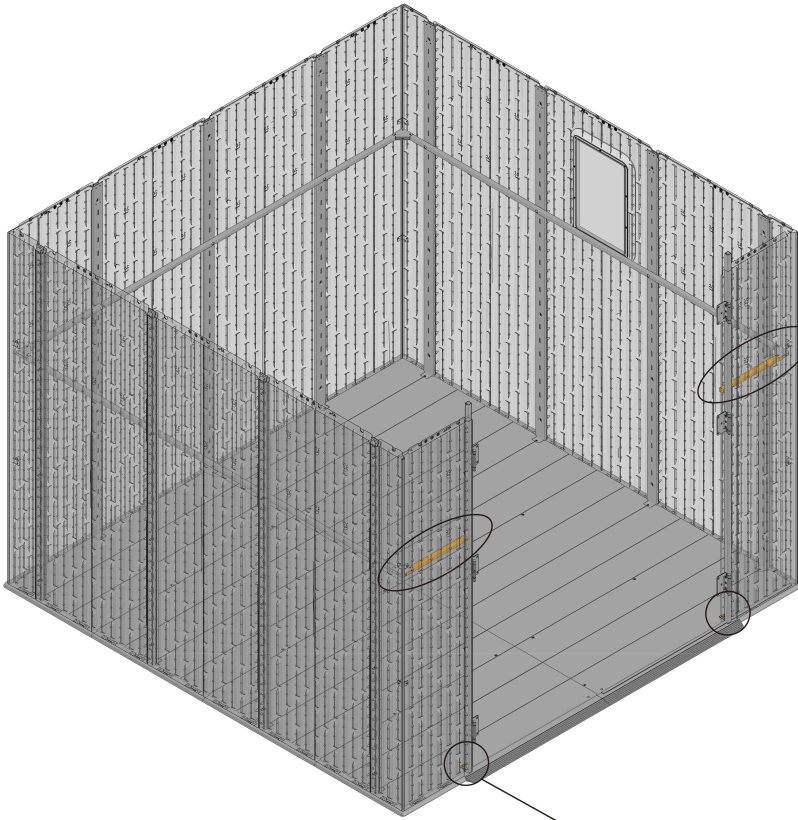

17



A43-pa x4



B58-pa x16

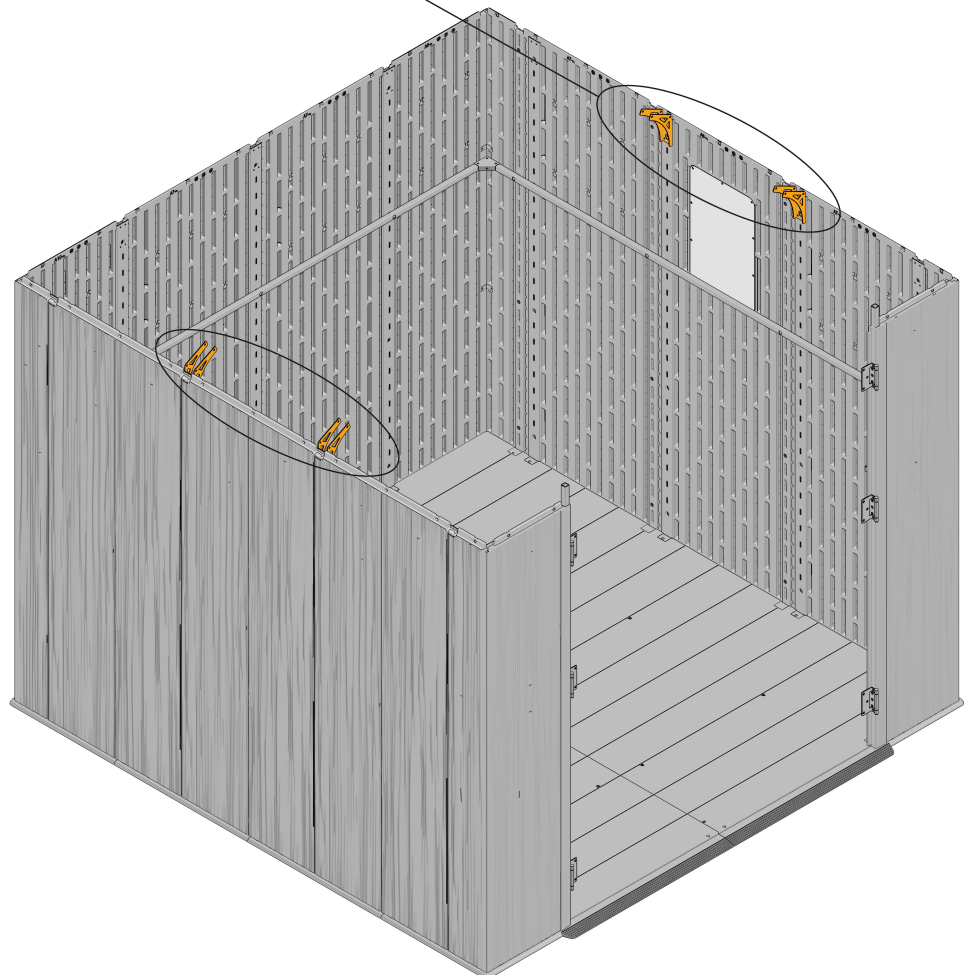
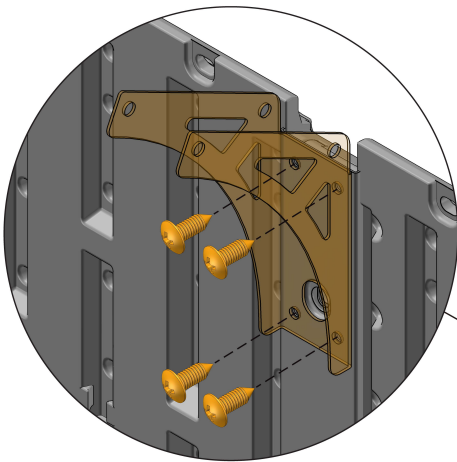
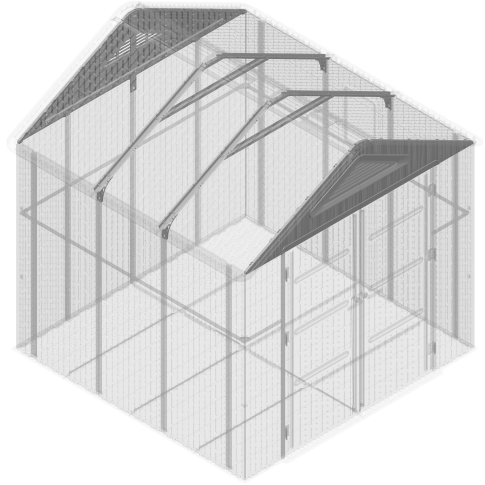

18

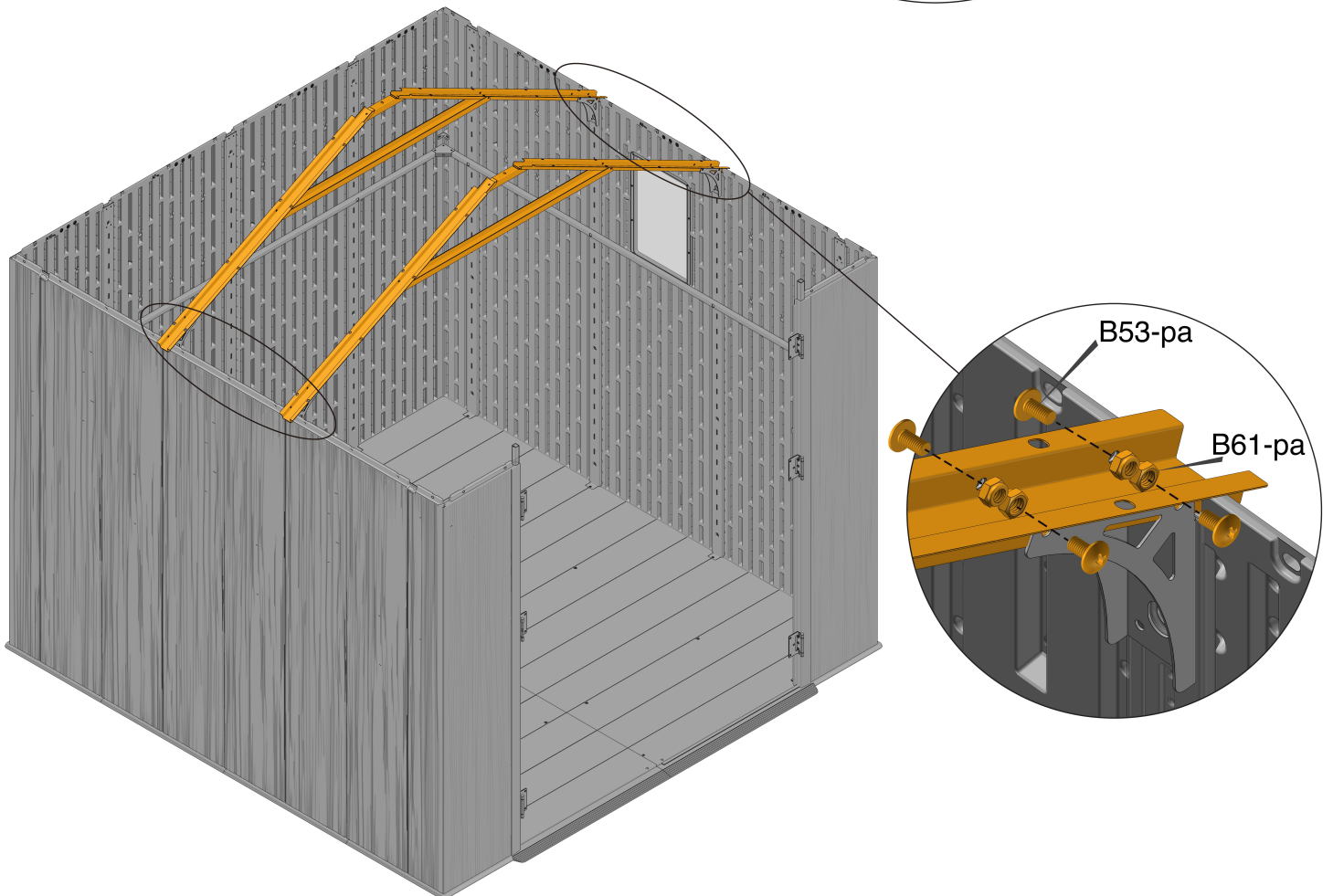
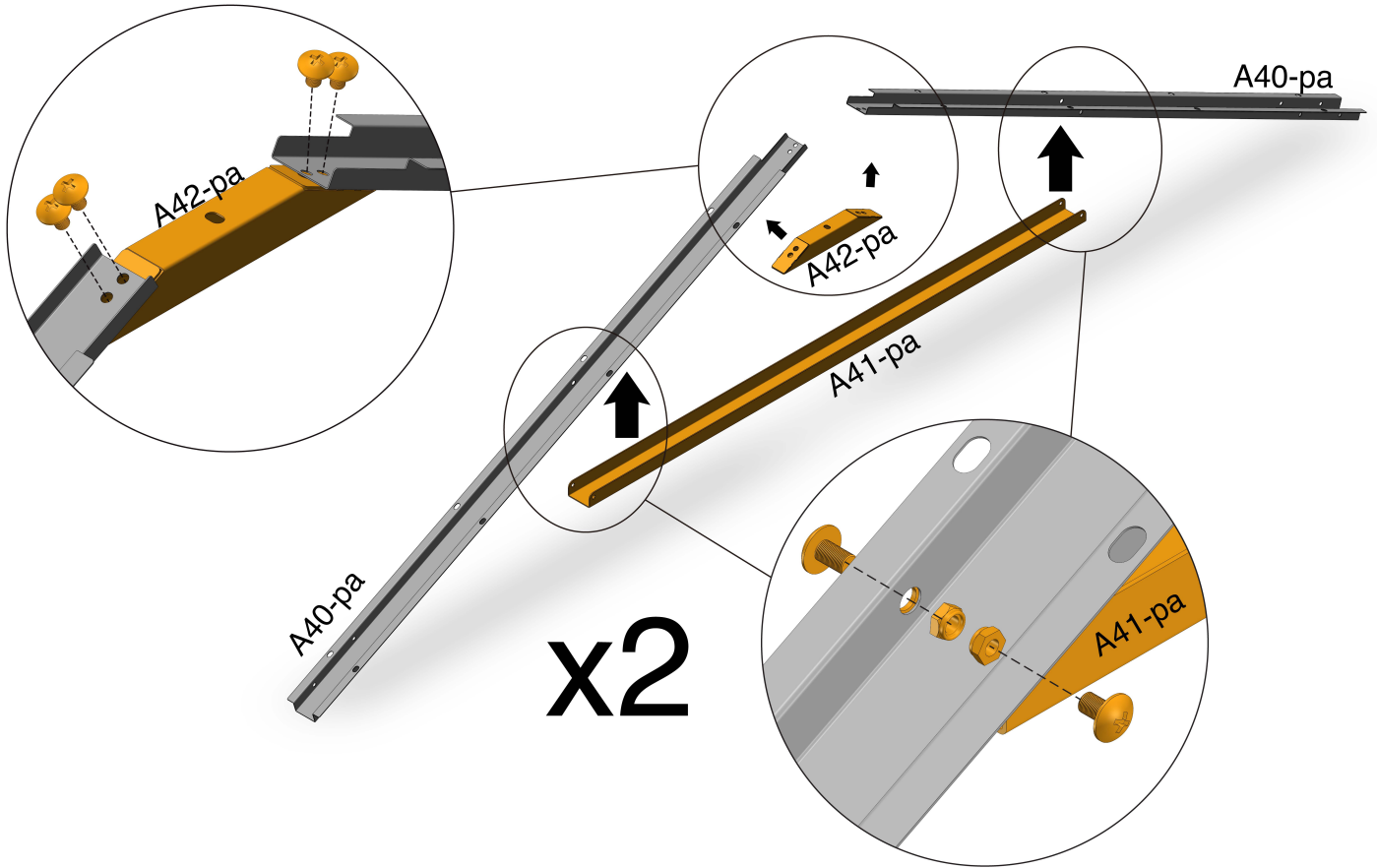
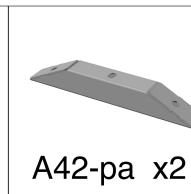
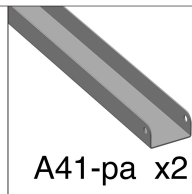
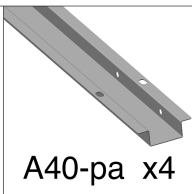

19

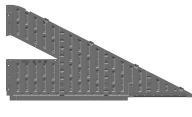

A12-pa x1

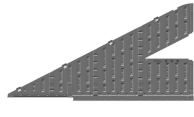

A13-pa x1



A24-pa x1

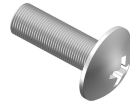

B54-pa x3



B51-pa x6

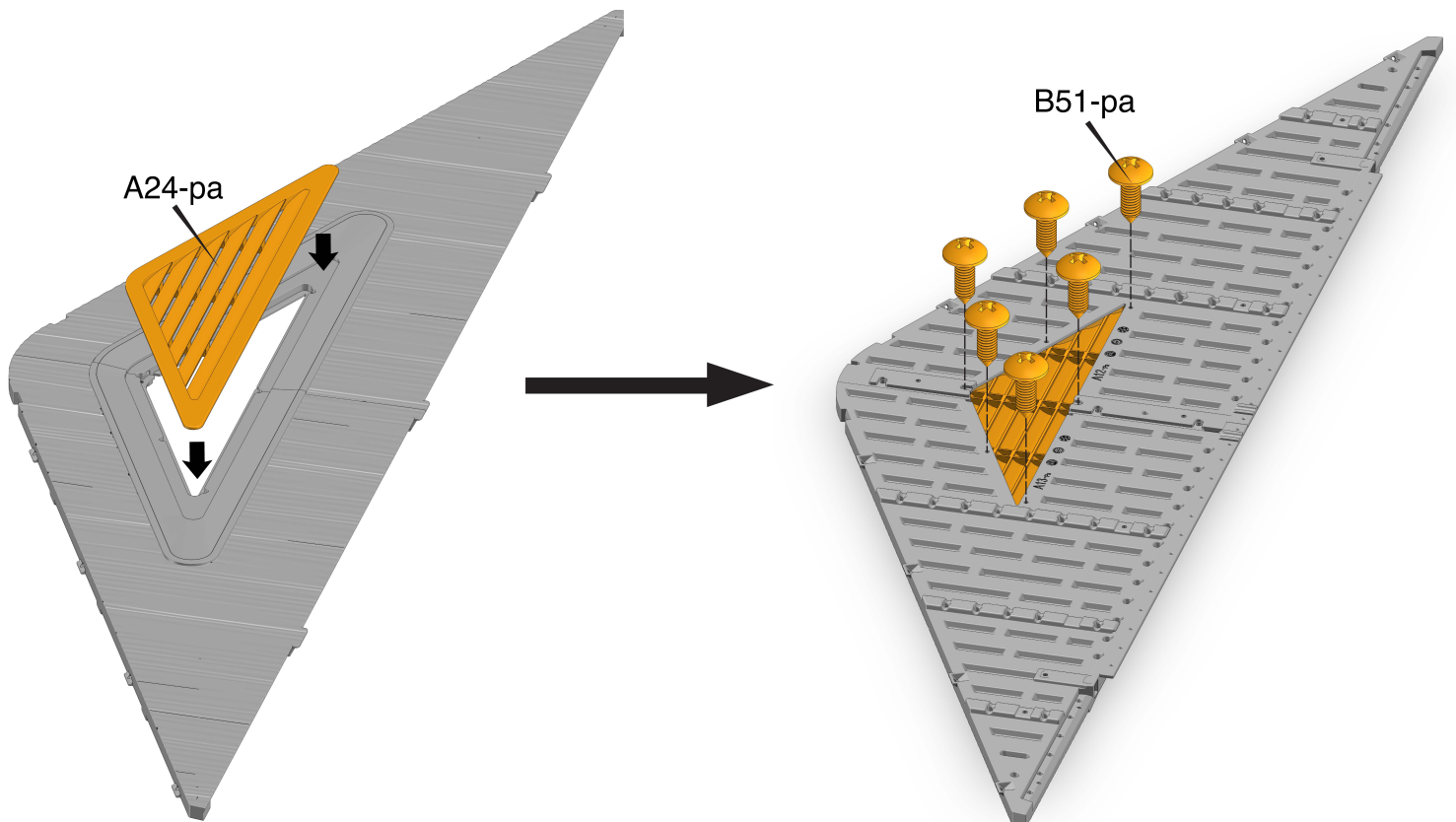
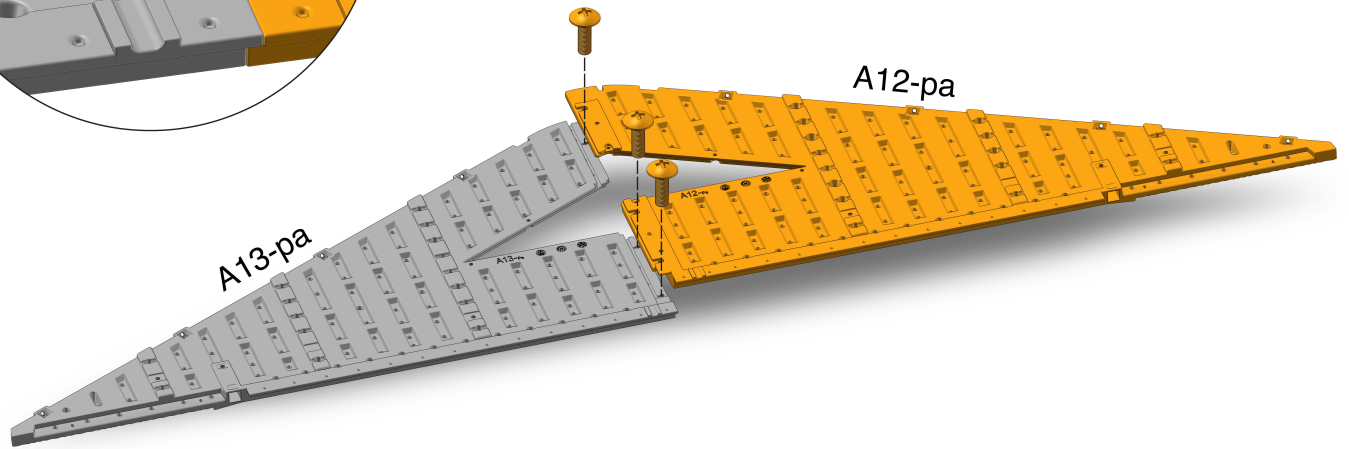
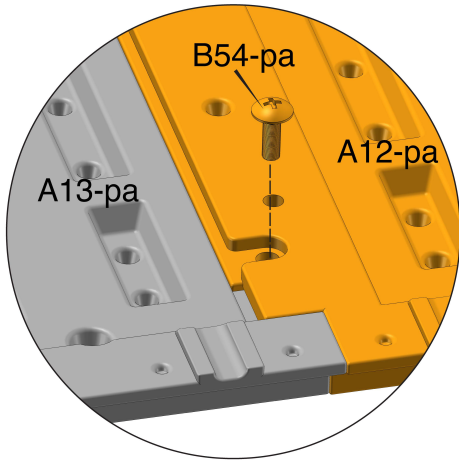

20

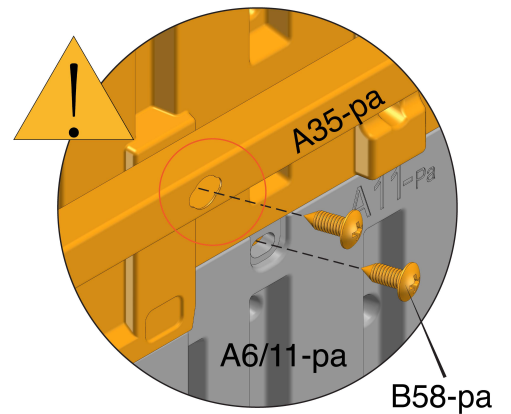
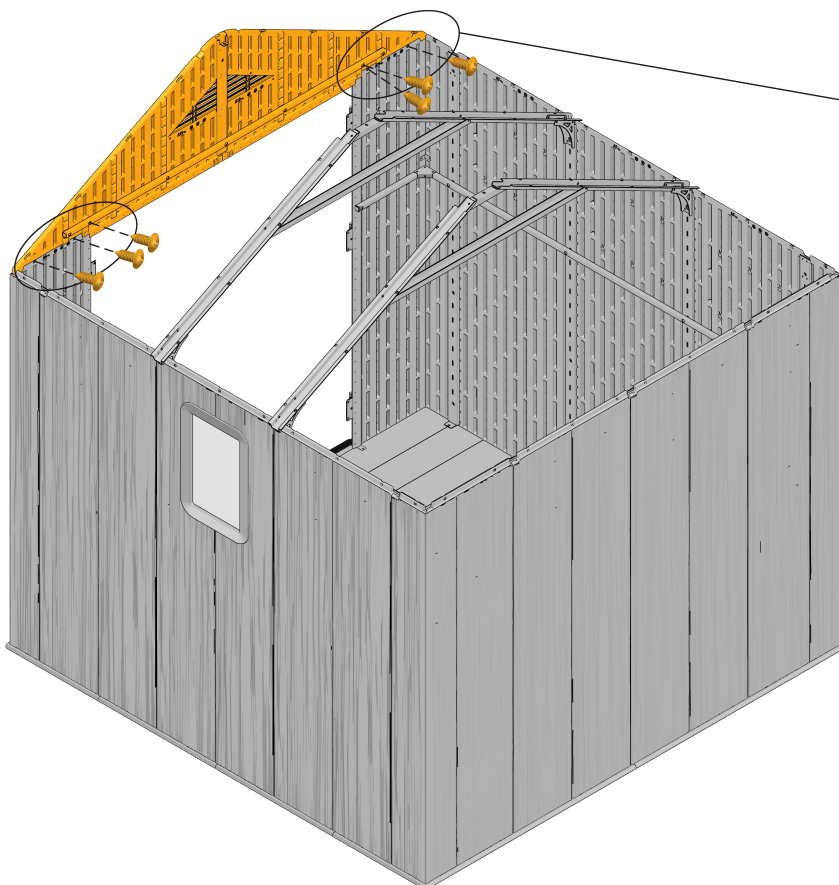
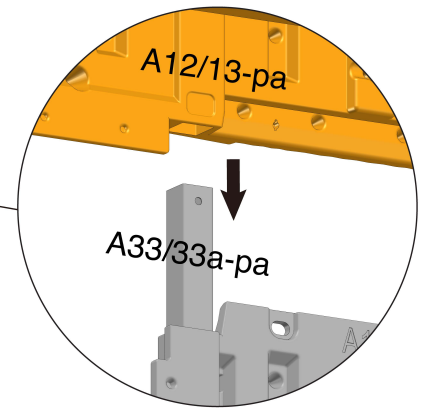
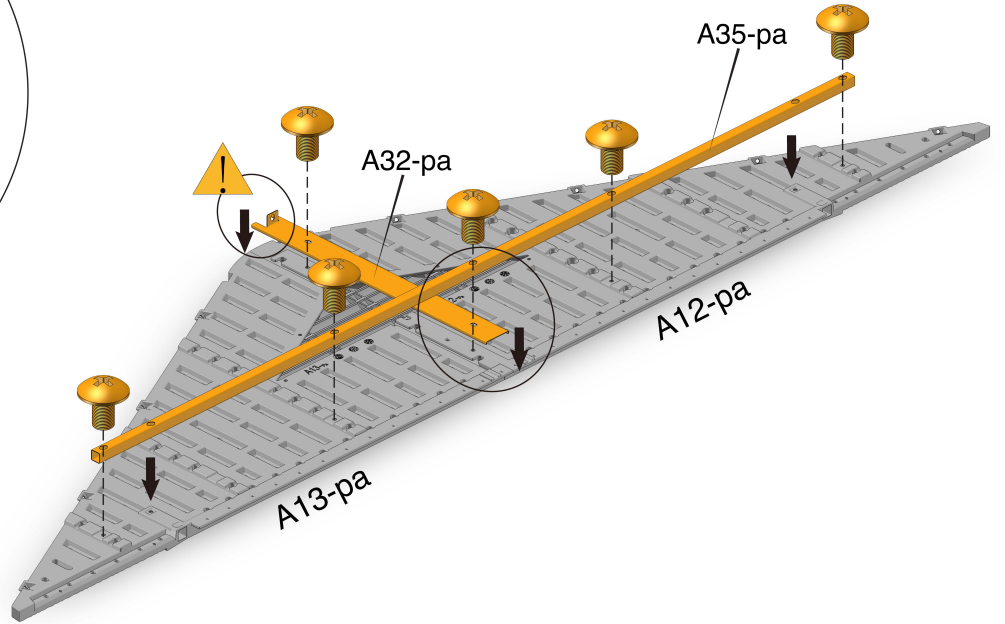
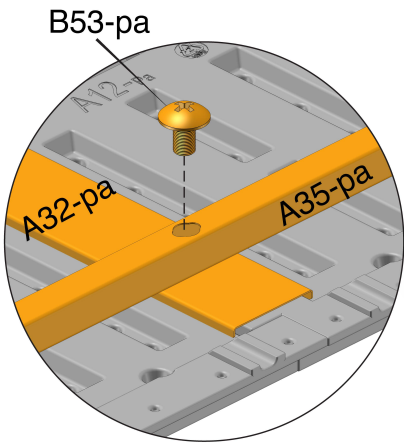
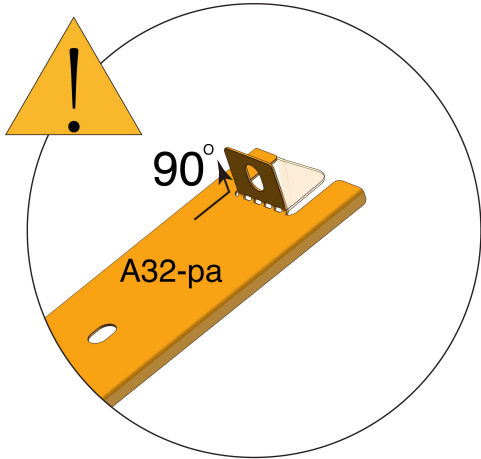
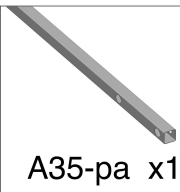
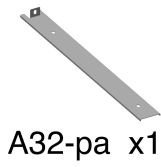

21

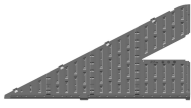

A14-pa x1

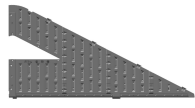

A15-pa x1



A24-pa x1

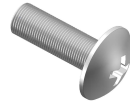

B54-pa x3



B51-pa x6

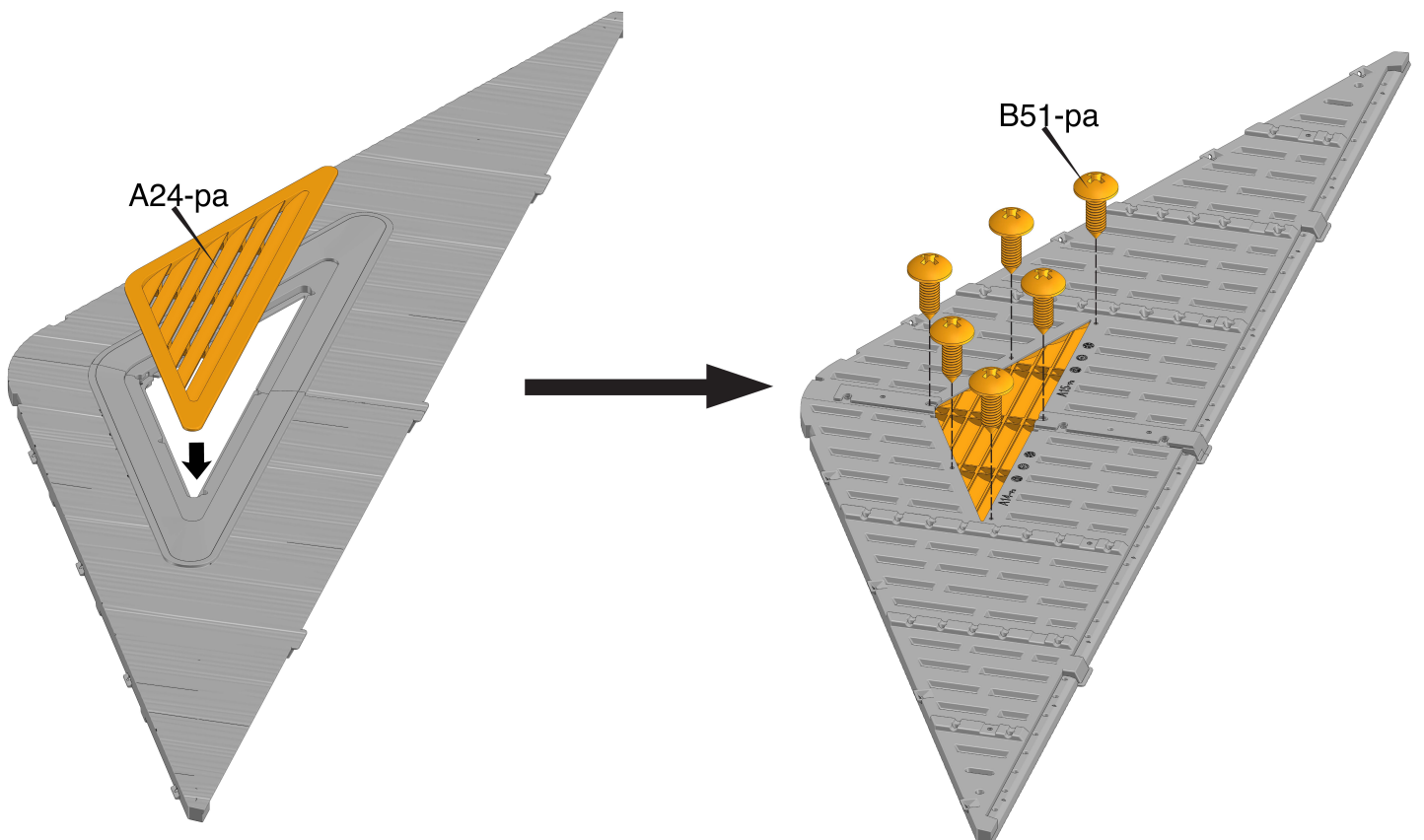
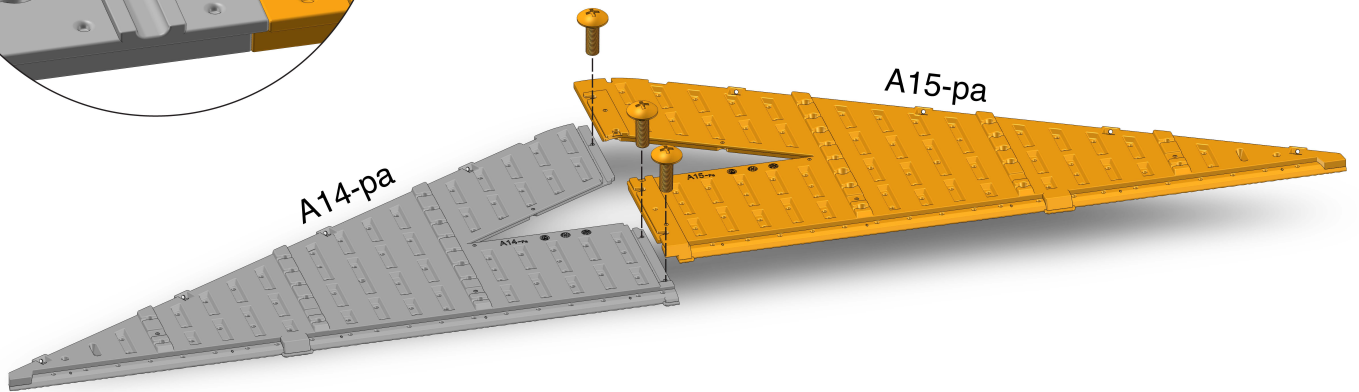
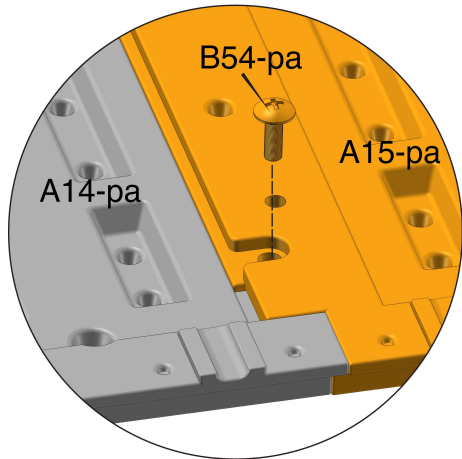

22

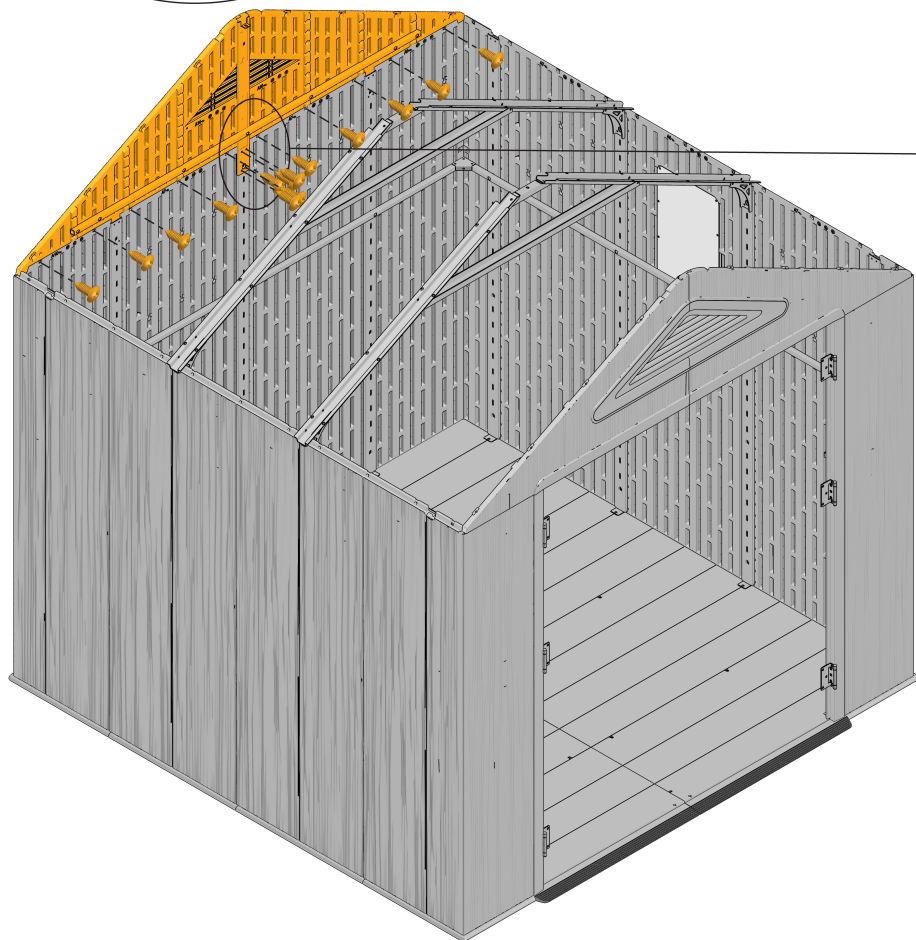
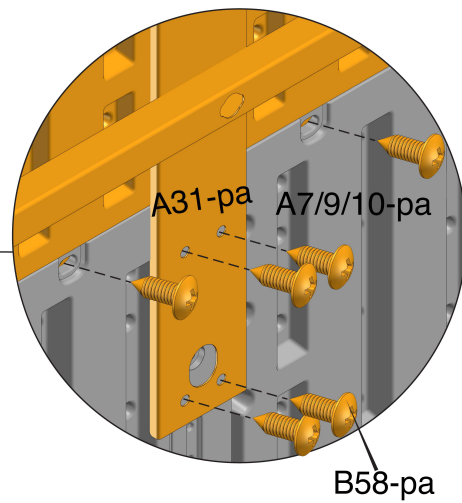
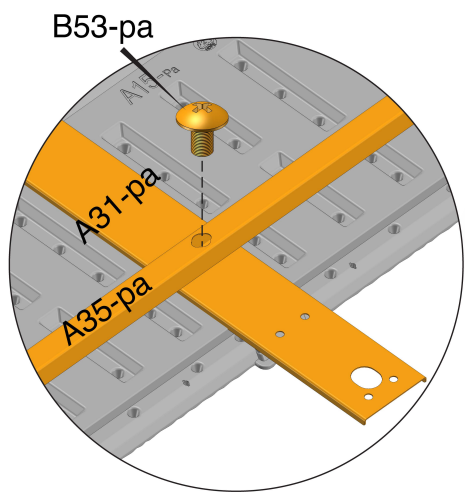
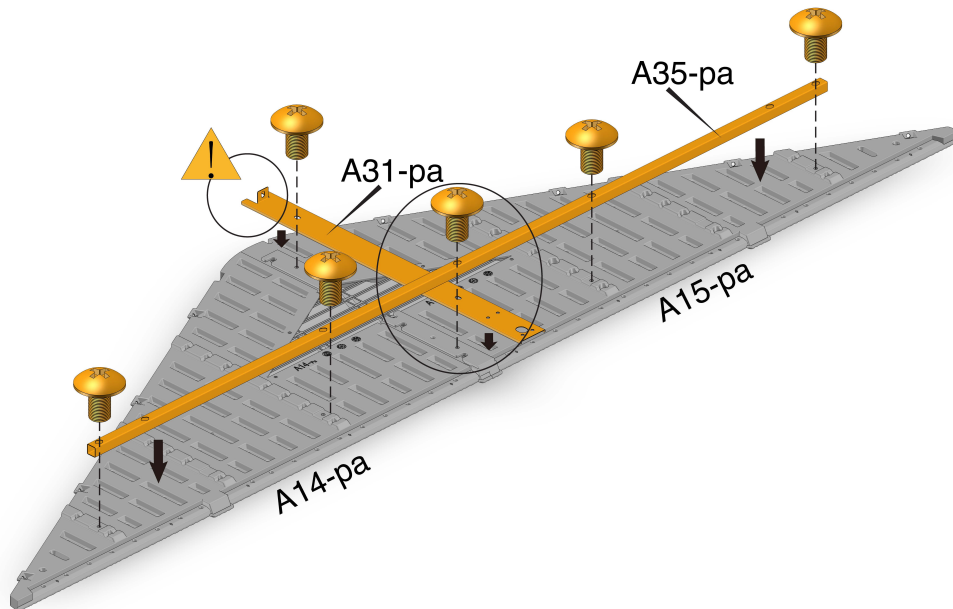
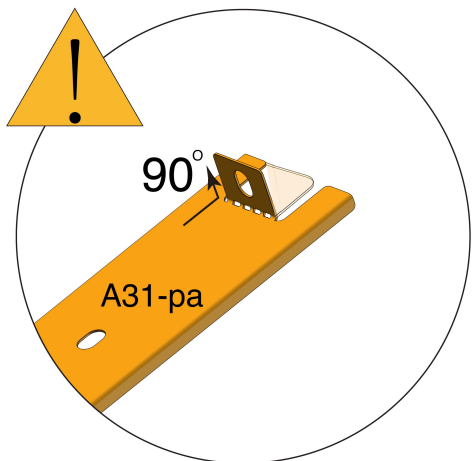
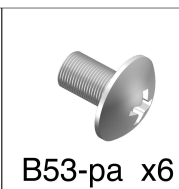
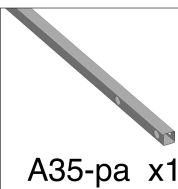
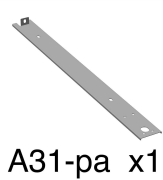

23

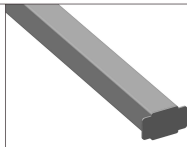

B36-pa x1

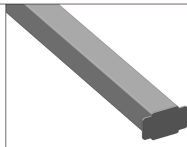

B37-pa x1



B56-pa x4



B53-pa x2

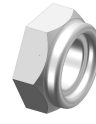

B61-pa x2

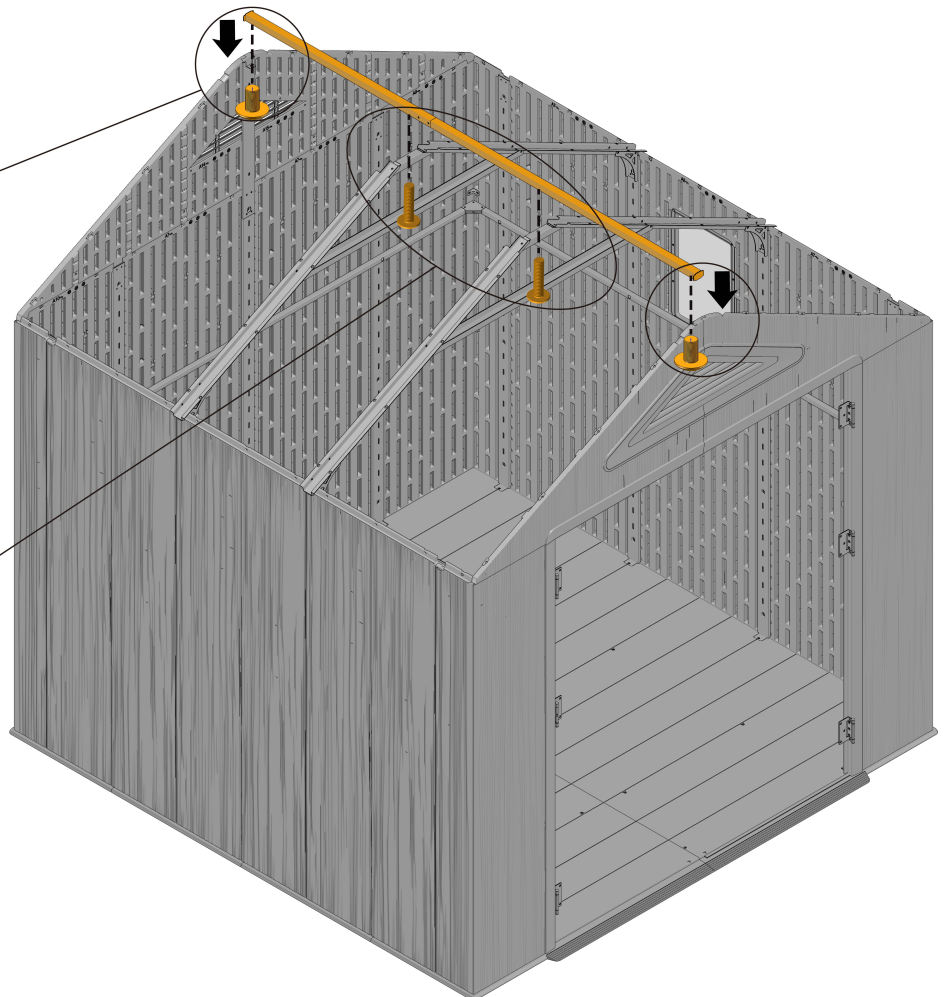
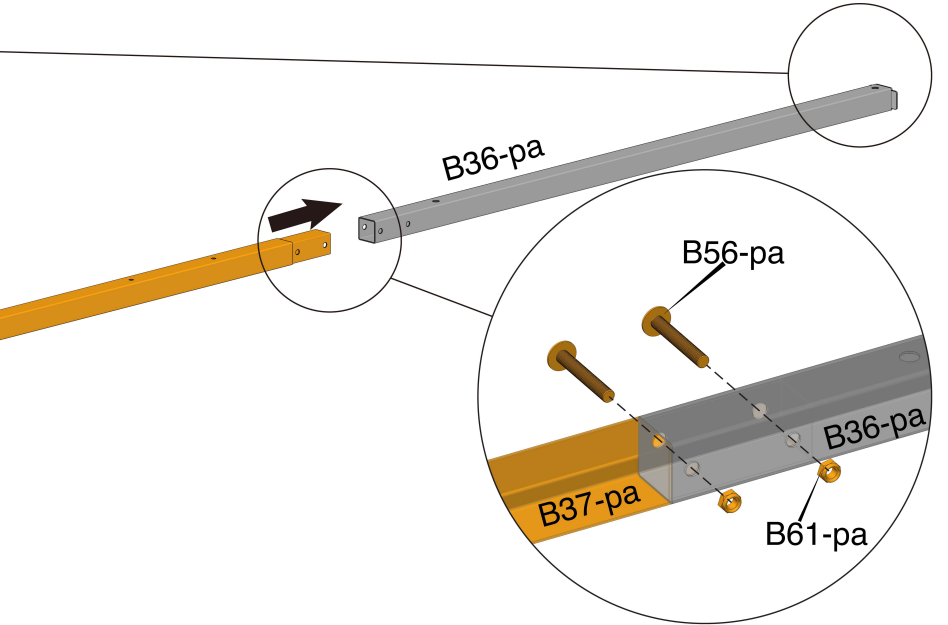
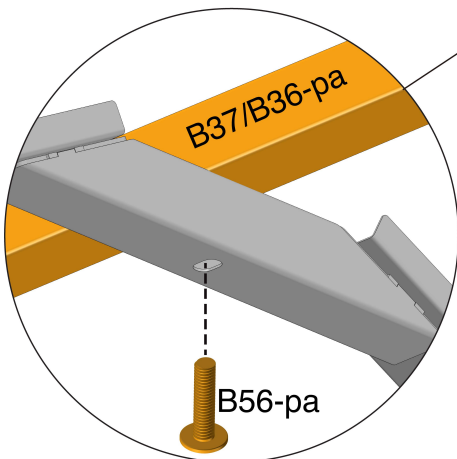
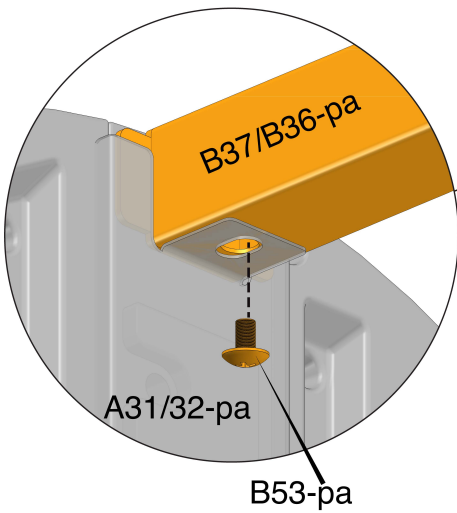
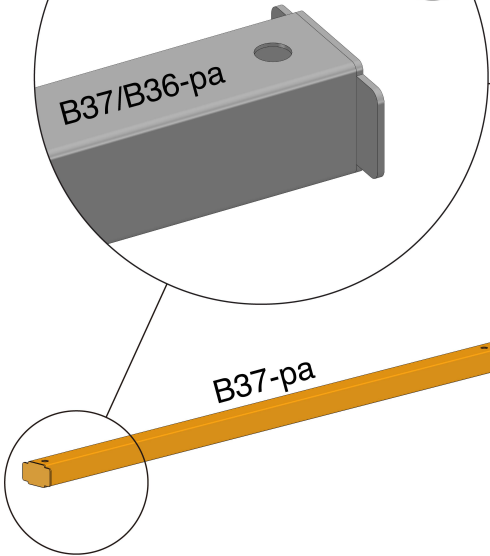
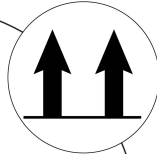

24



A16-pa x2



A17-pa x2



A18-pa x2

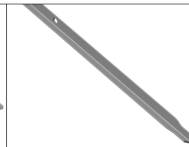

A44-pa x4

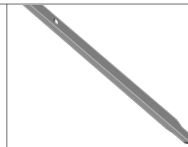

A45-pa x2



B51-pa x12

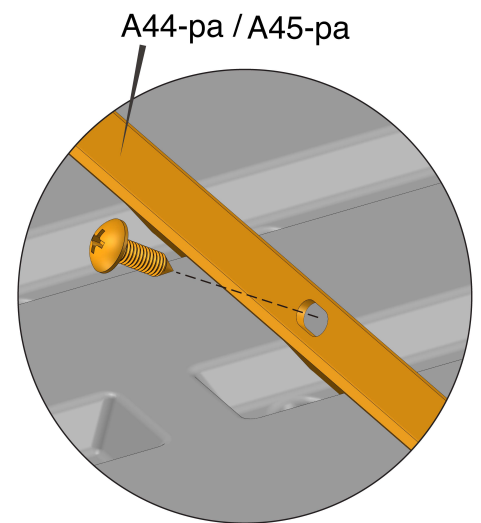
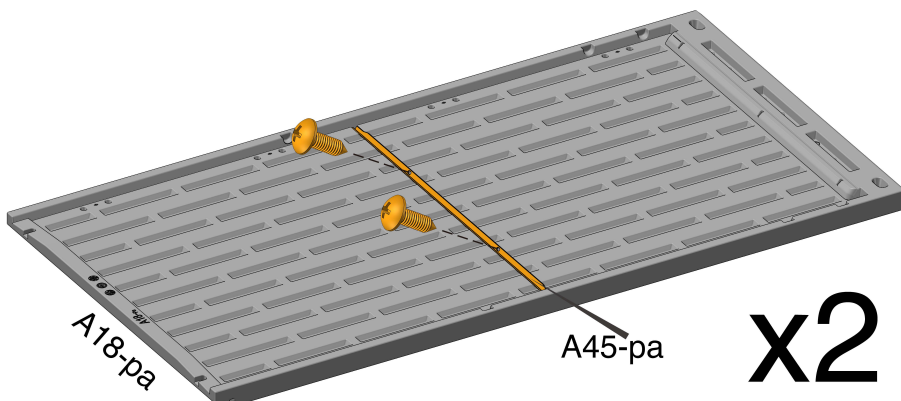
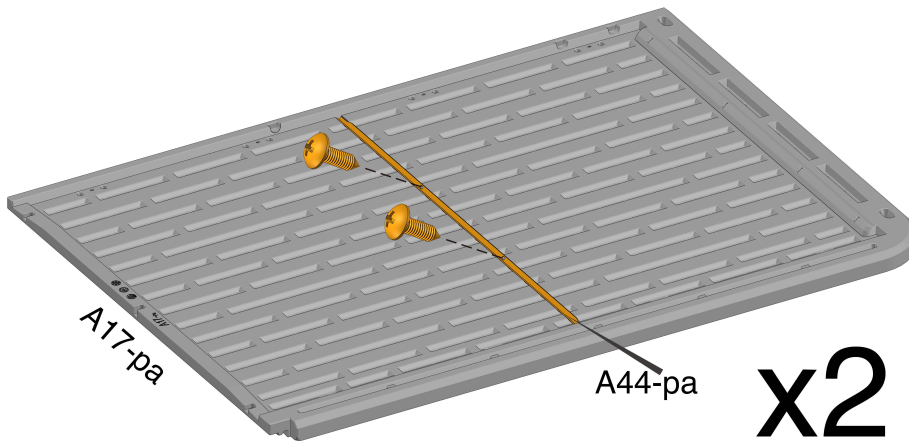
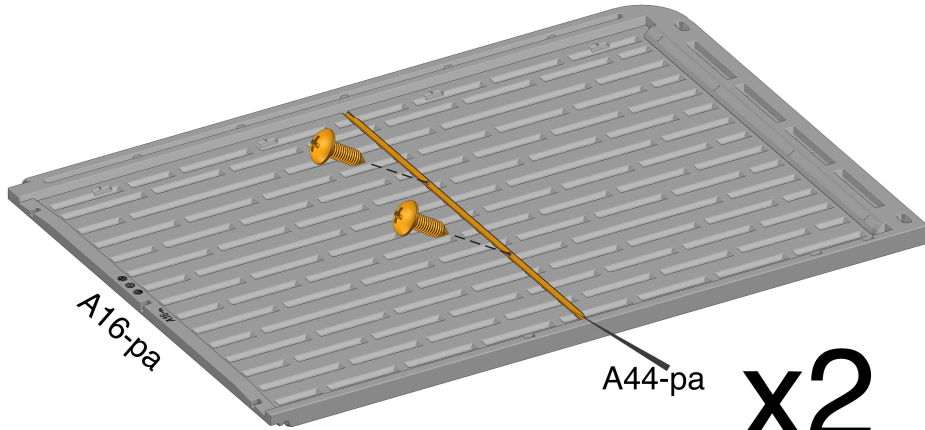
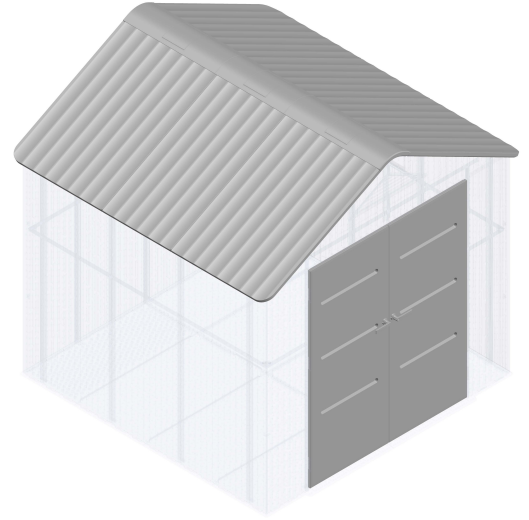
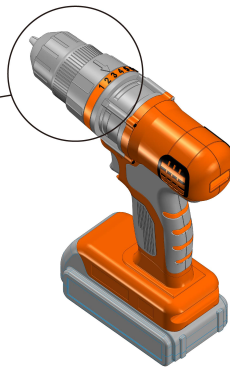
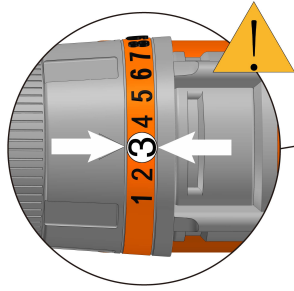

25

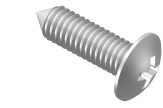

B59-pa x16



B58-pa x8

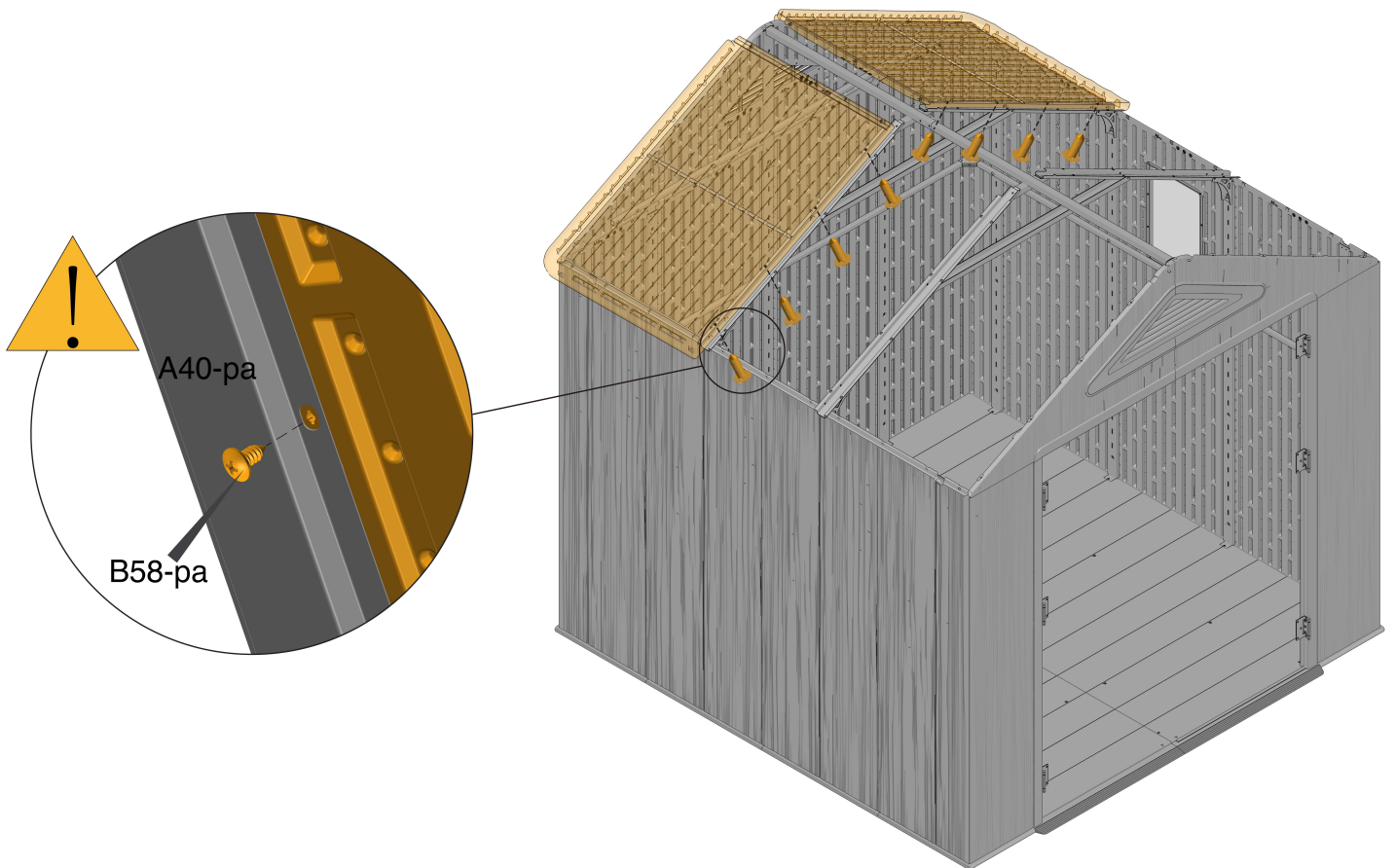
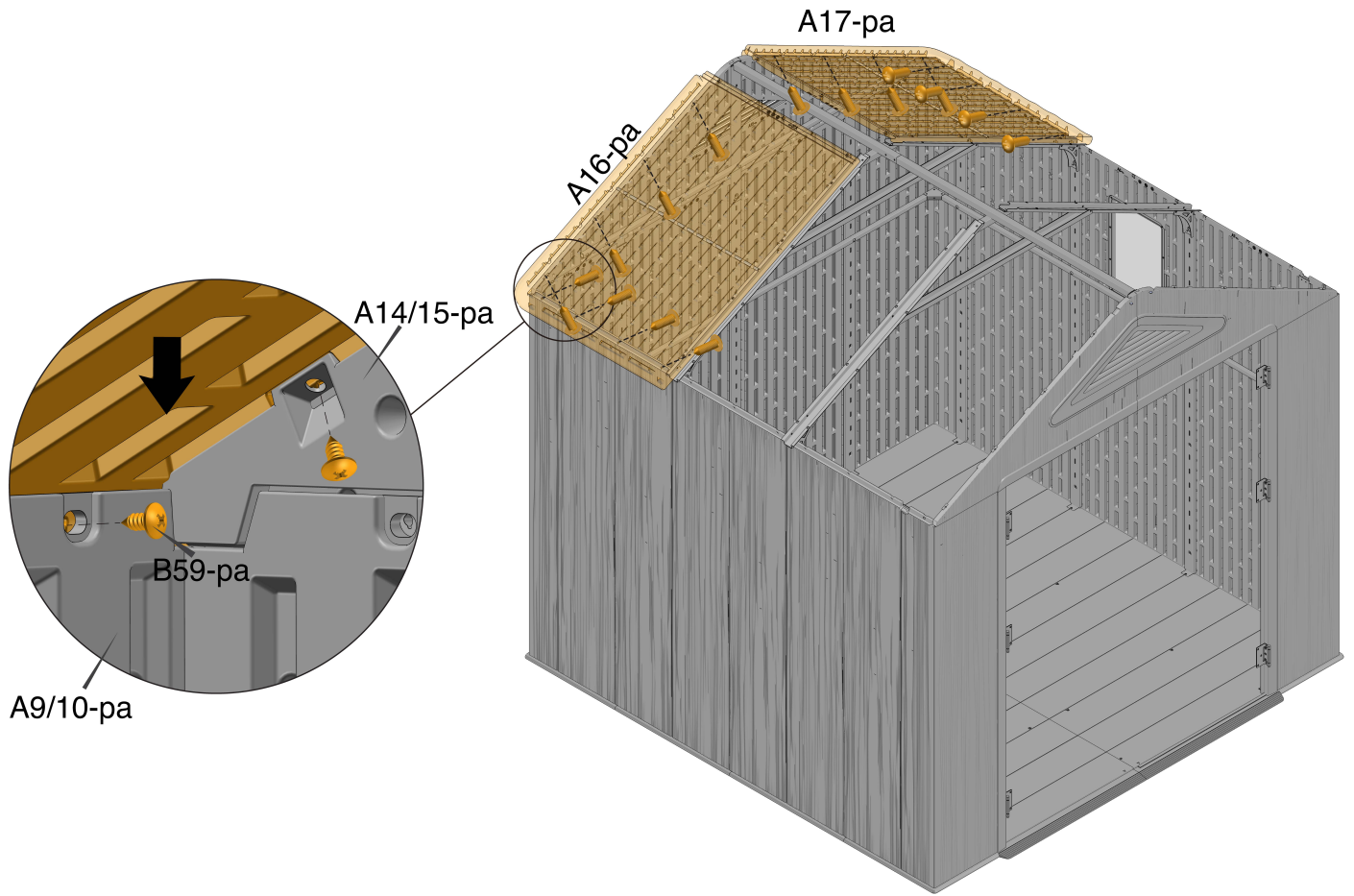

26

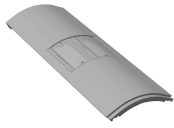

A19-pa x1

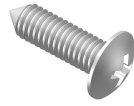

B59-pa x12

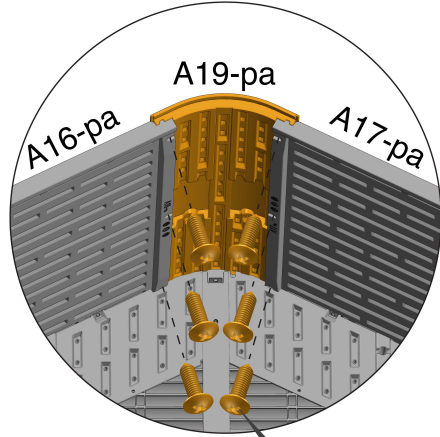
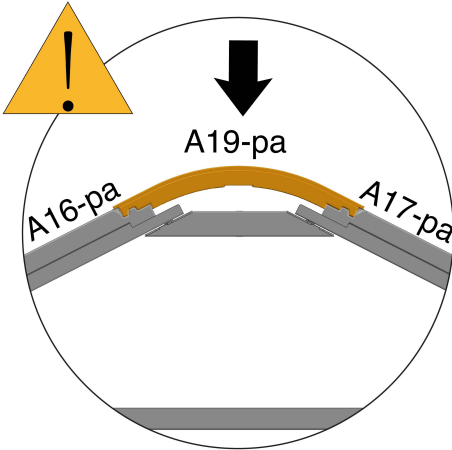

B59-pa

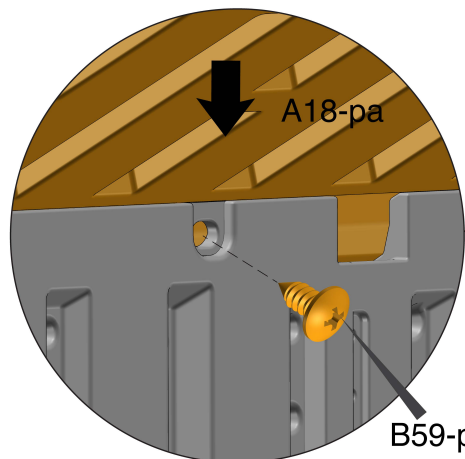
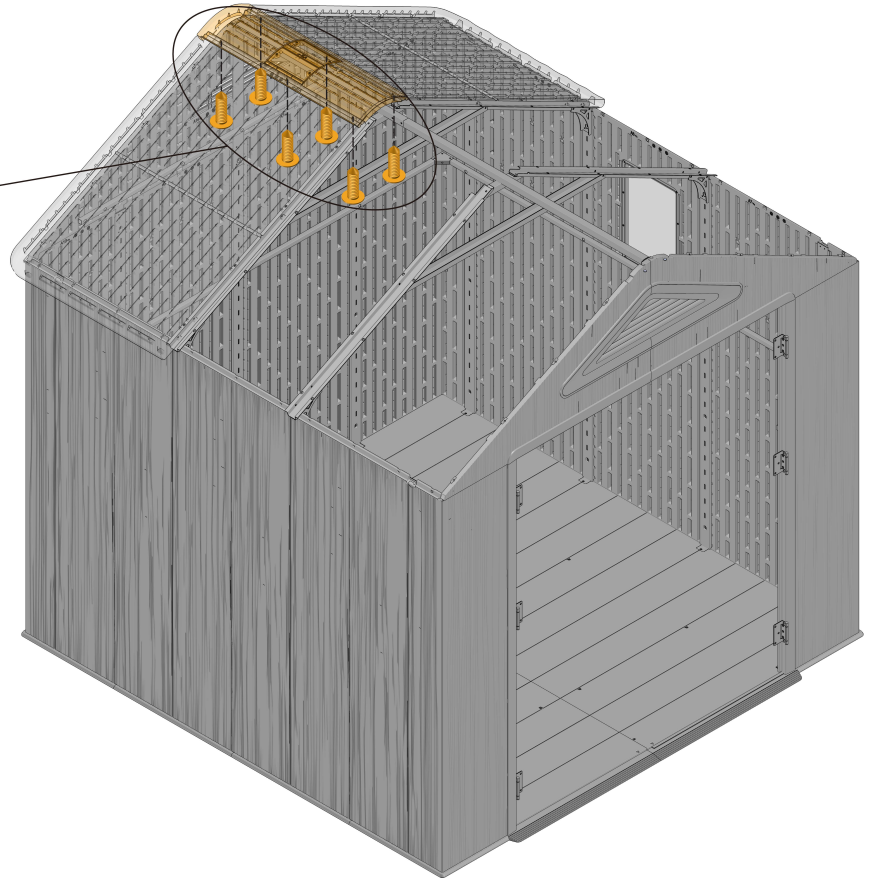

B59-pa

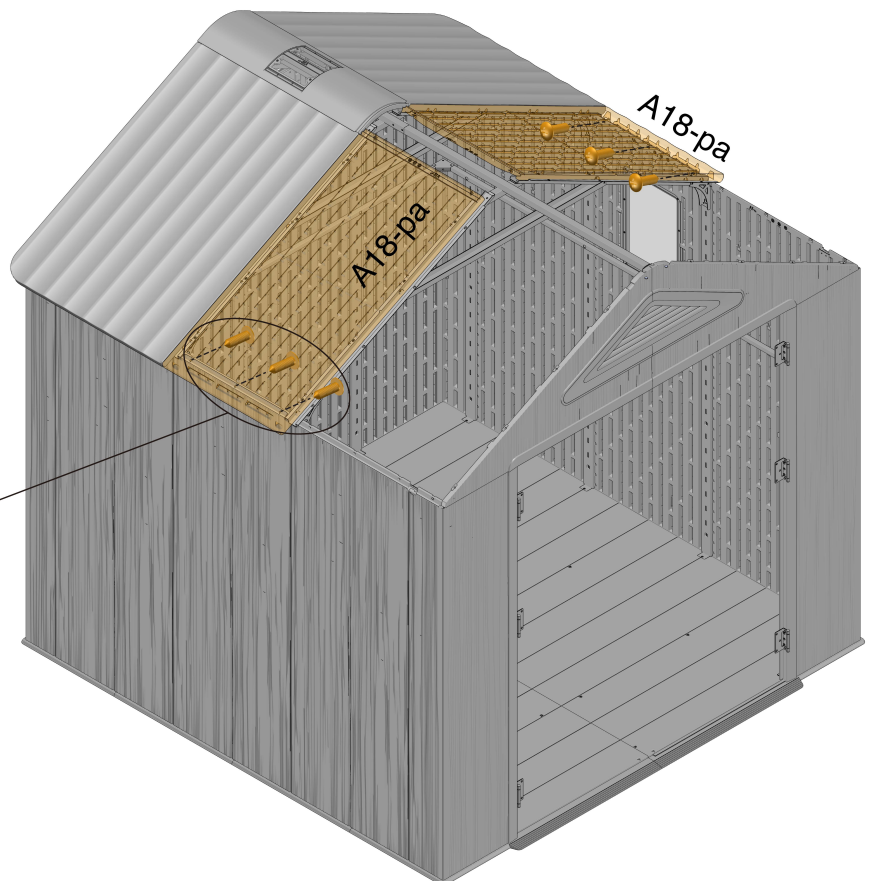

27

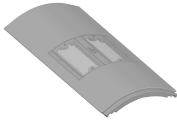

A21-pa x1



B58-pa x16

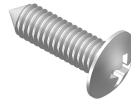

B59-pa x4

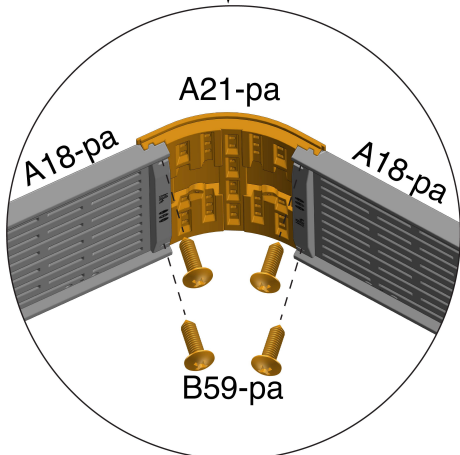
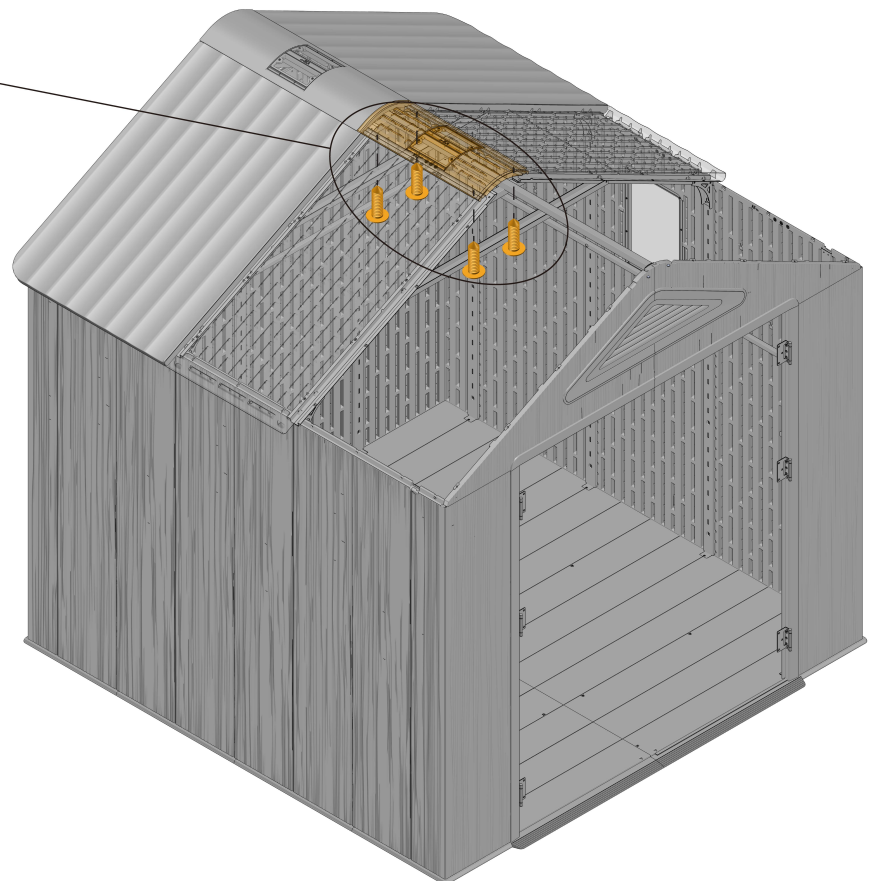
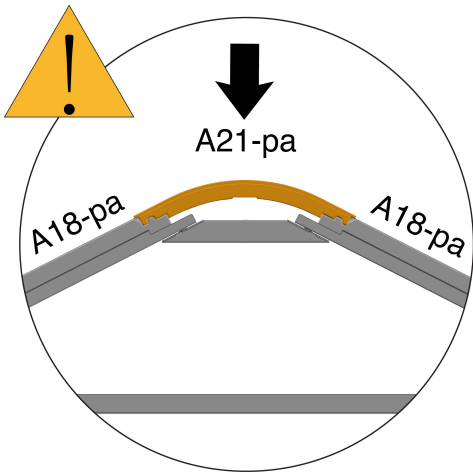
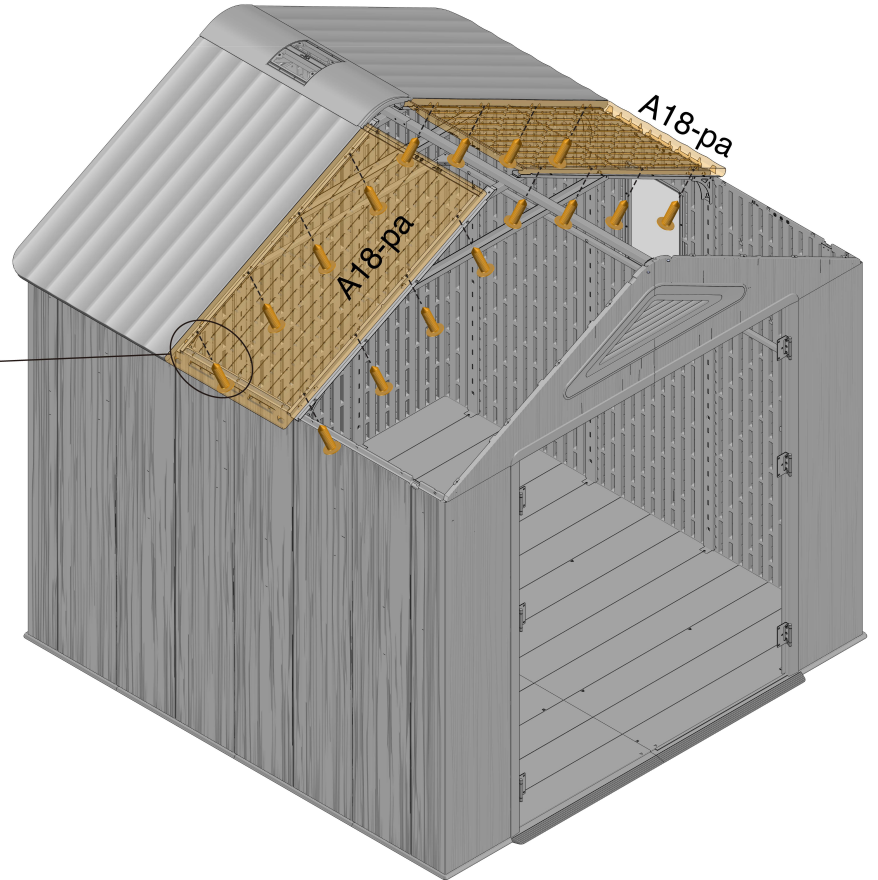
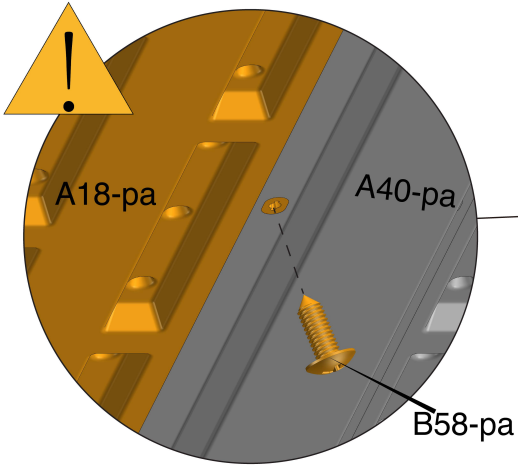

28



B58-pa x8

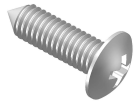

B59-pa x16

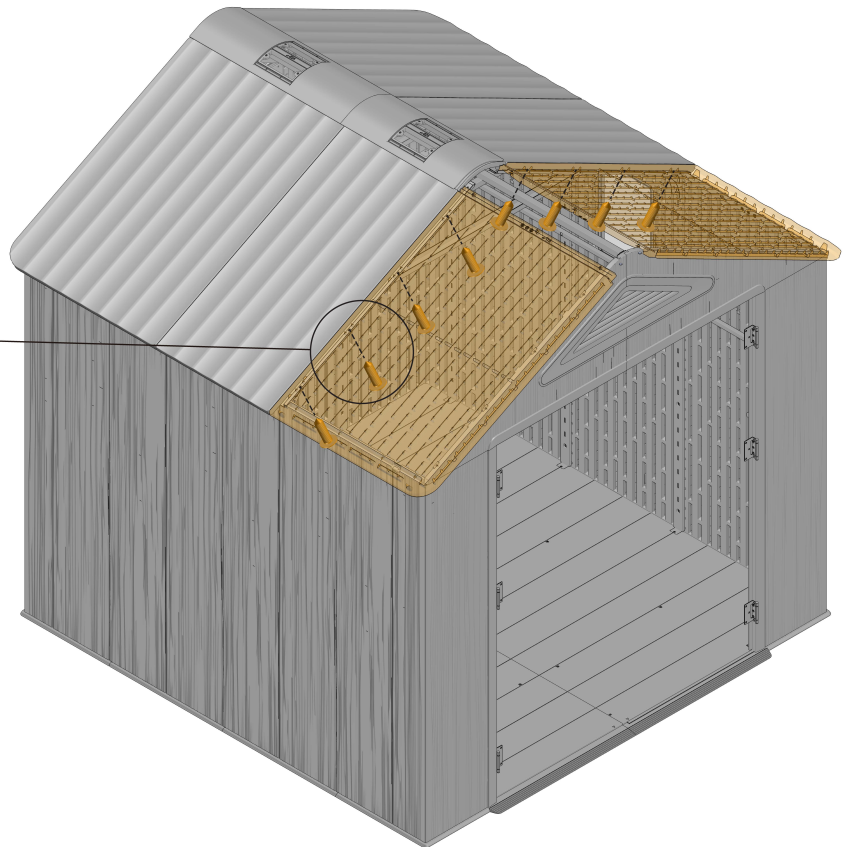
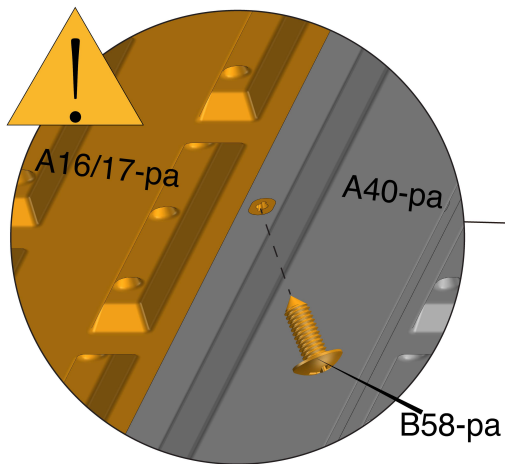
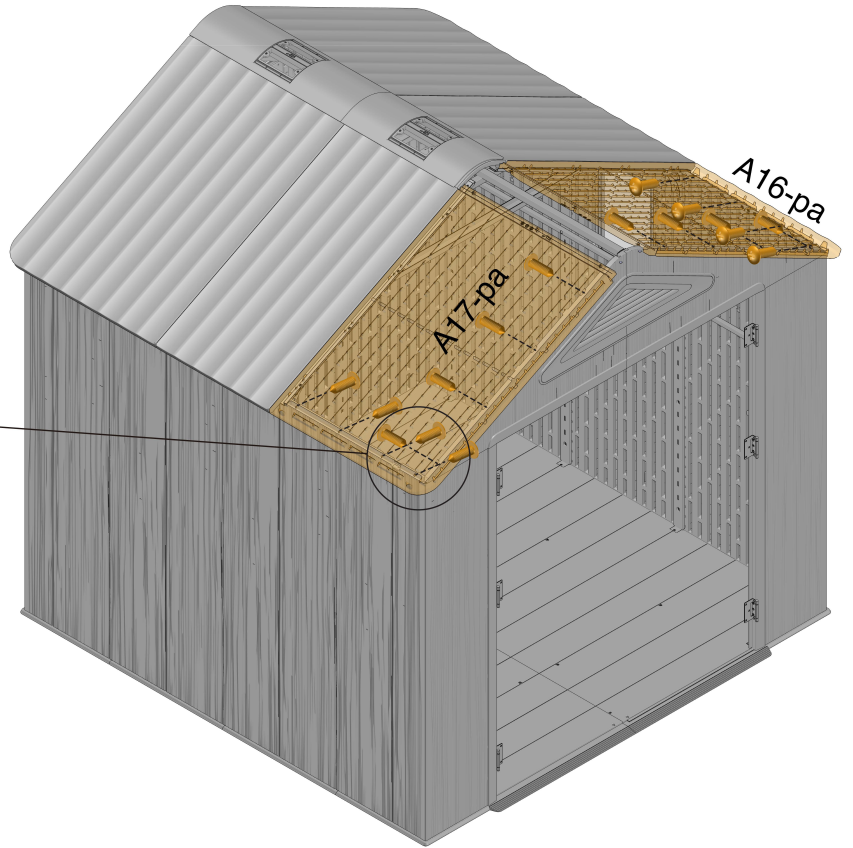
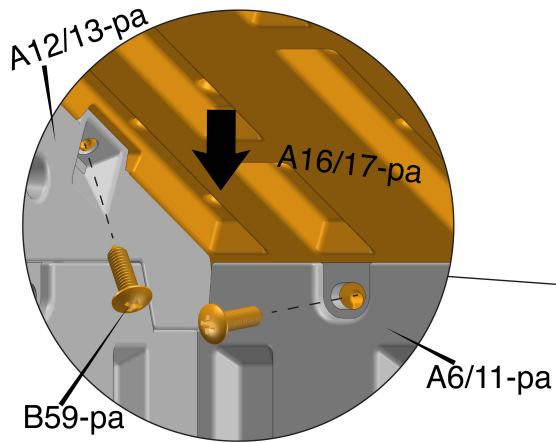

29

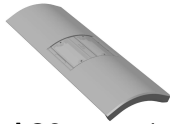

A20-pa x1

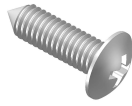

B59-pa x6

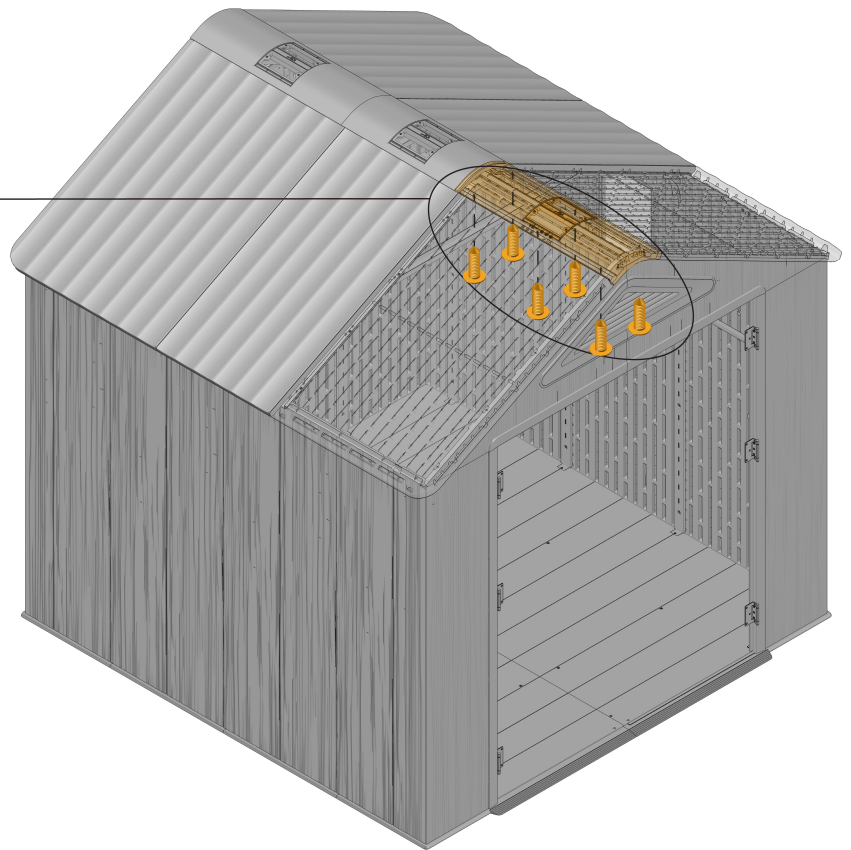
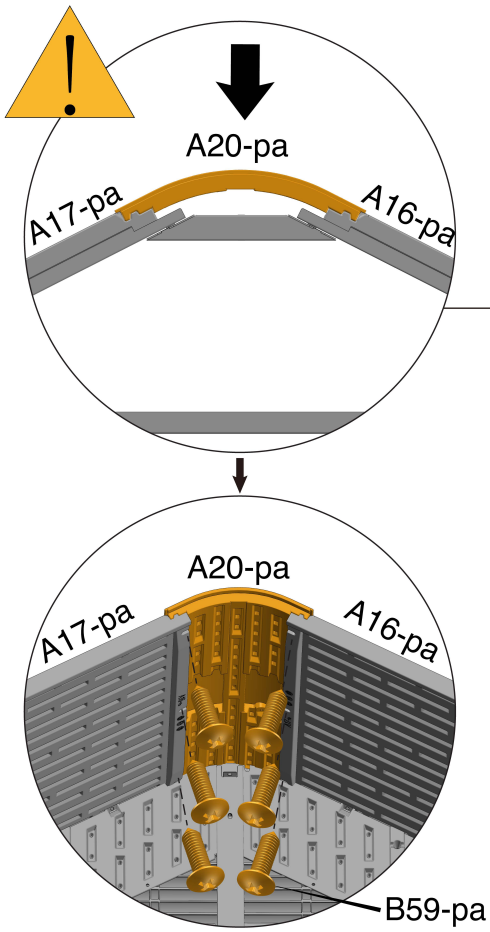

30

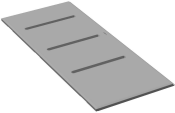

A22-pa x1

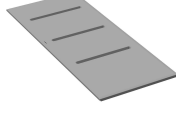

A23-pa x1

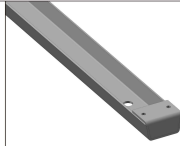

A34-pa x2

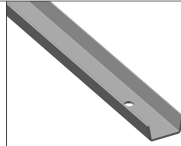

A34a-pa x2



B57-pa x20

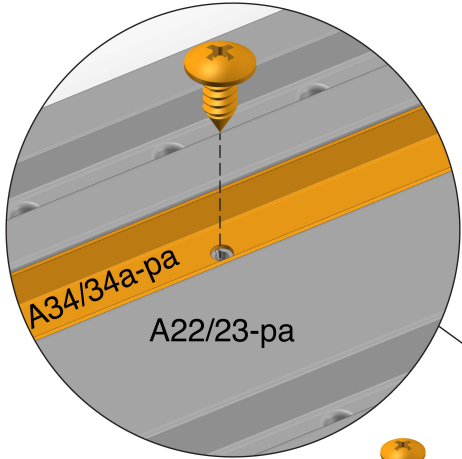

A22/23-pa

A34/34a-pa

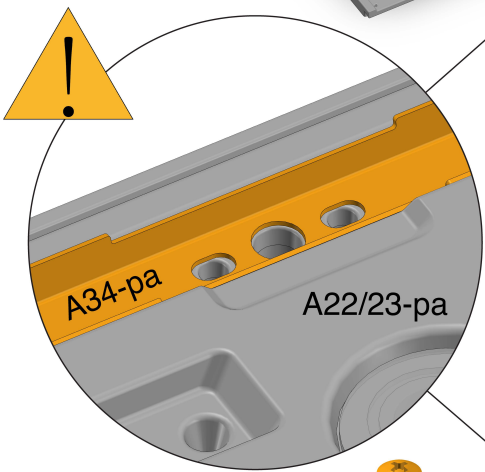
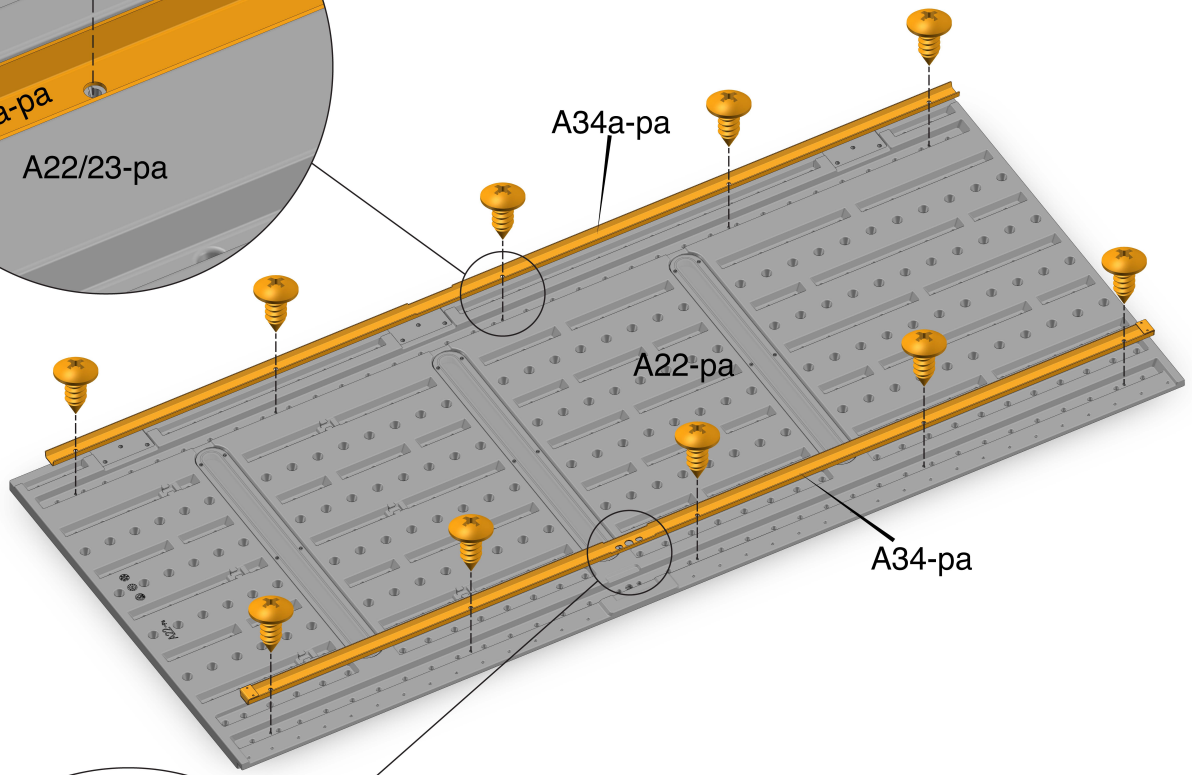

A22/23-pa

A34-pa

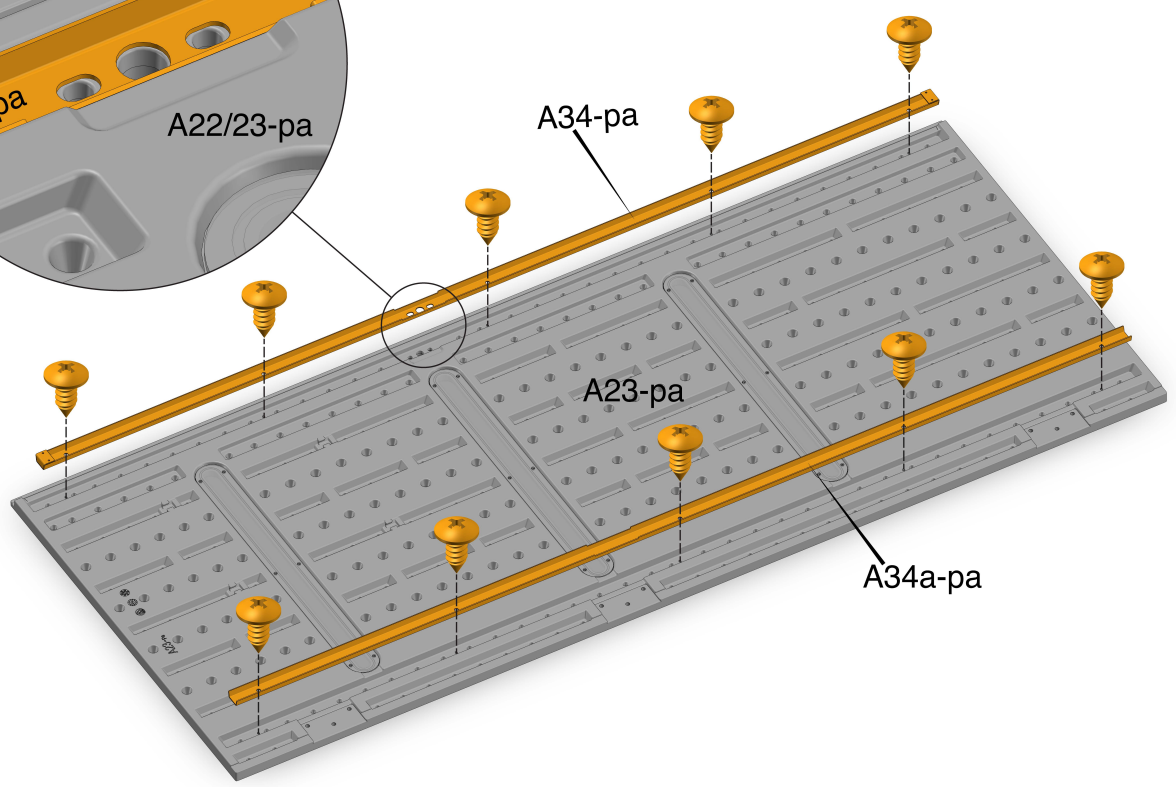

31



13-pa x2



14-pa x2



B51-pa x8

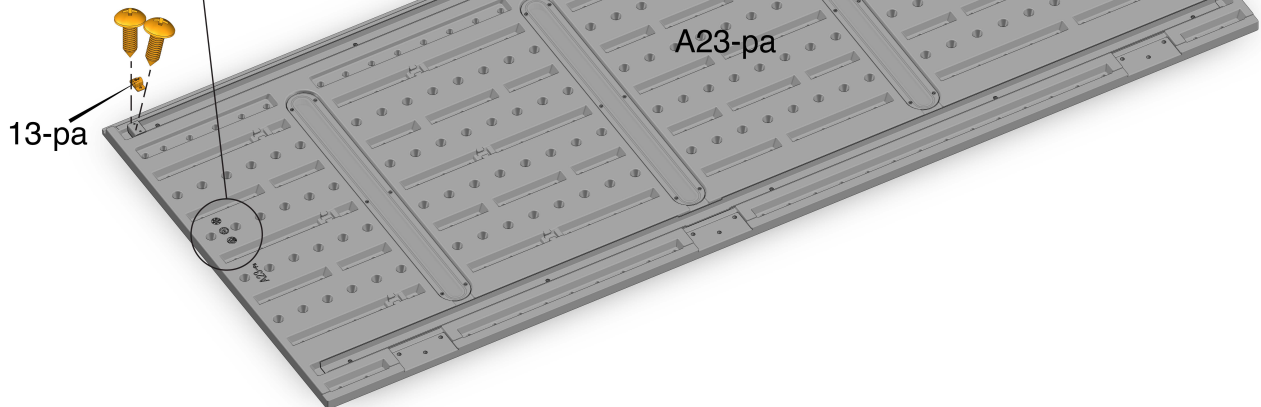
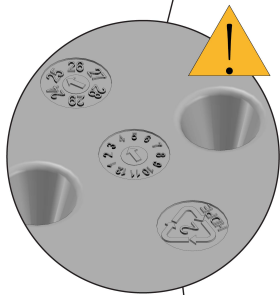
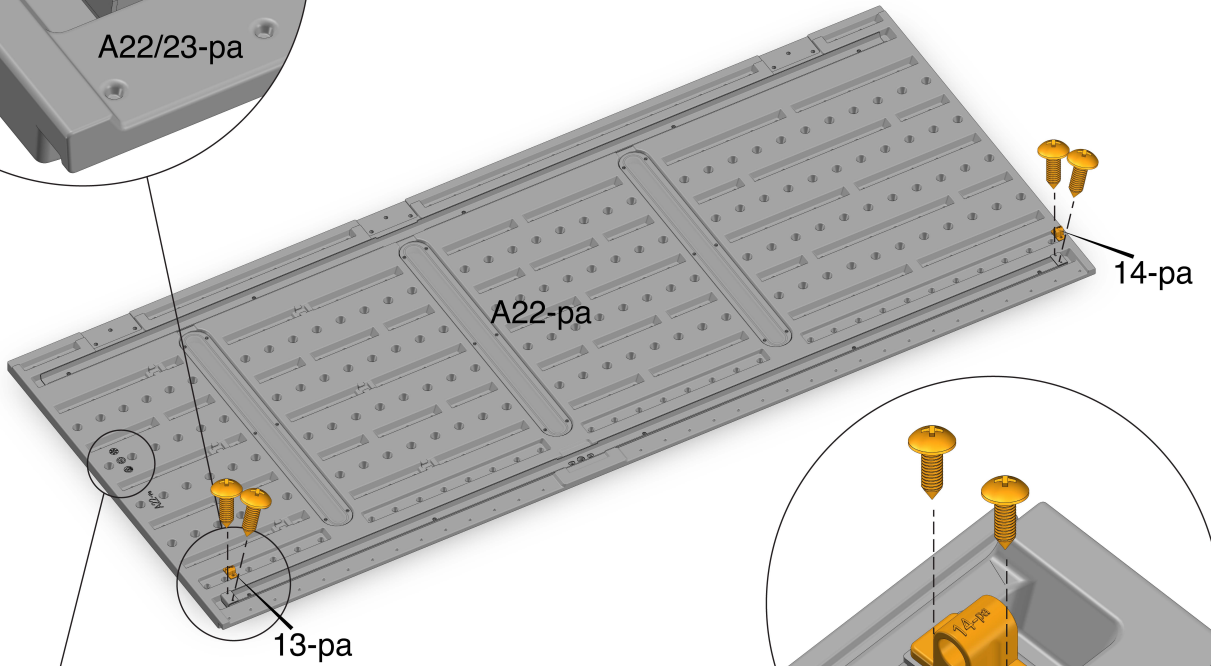
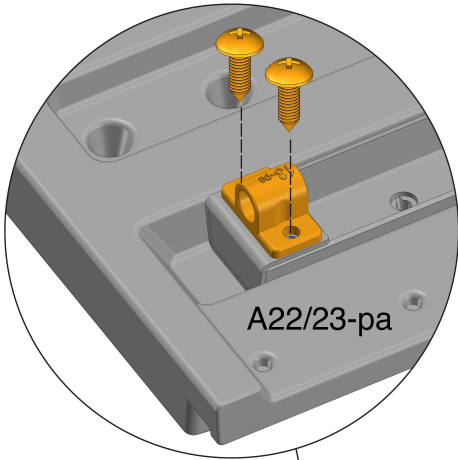

32



B53-pa x9

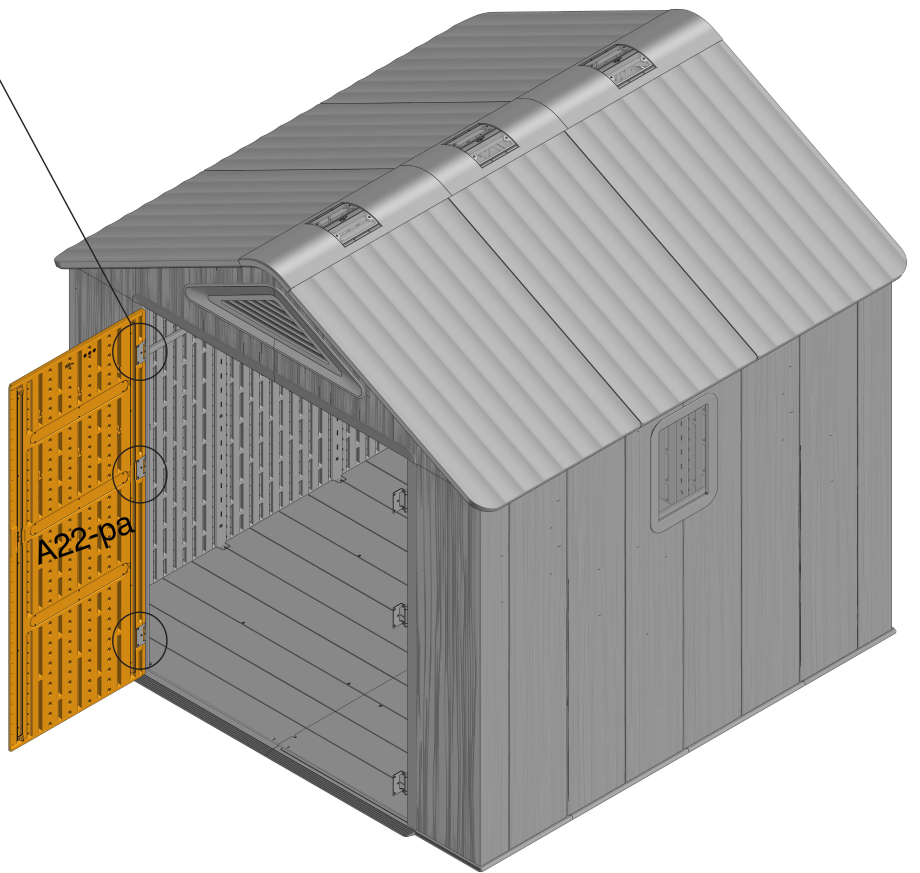
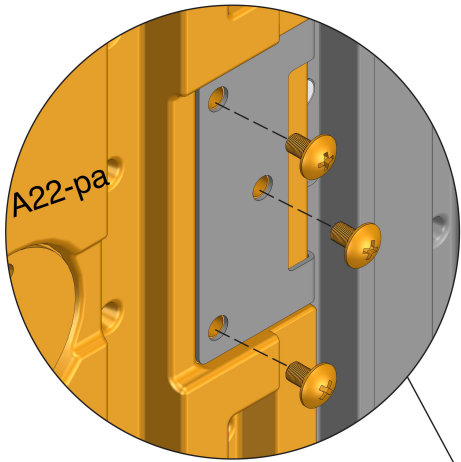

33



1-pa x1



1.1-pa x2



1.2-pa x2

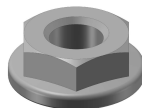

1.3-pa x1

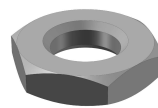

1.4-pa x1



1.5-pa x1



7-pa x1

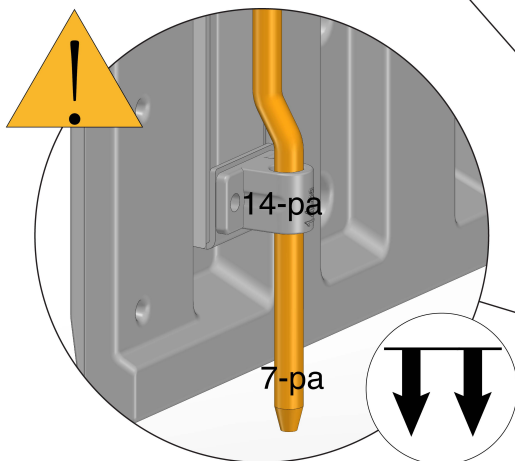
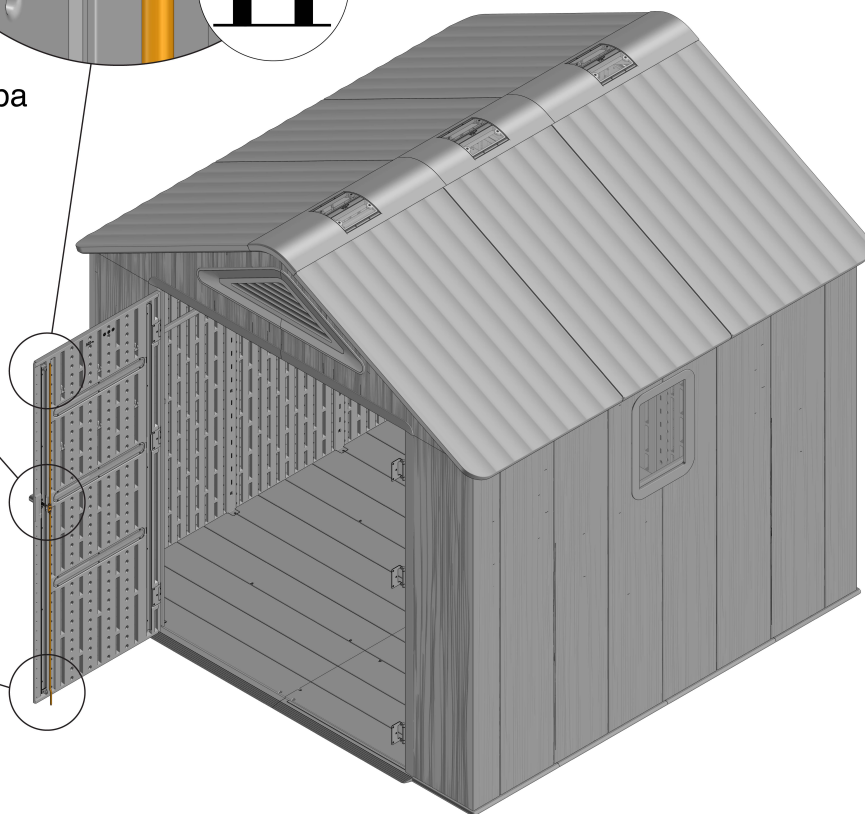
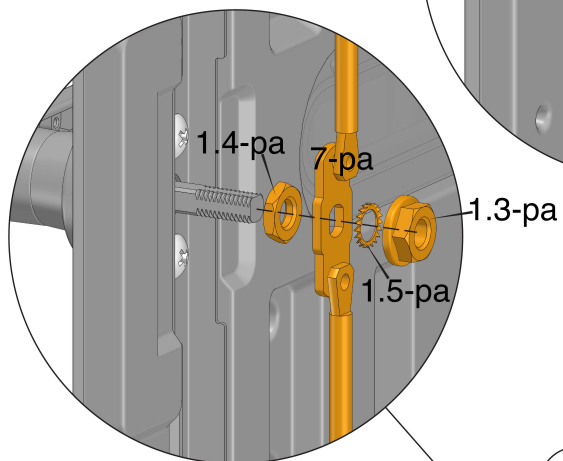
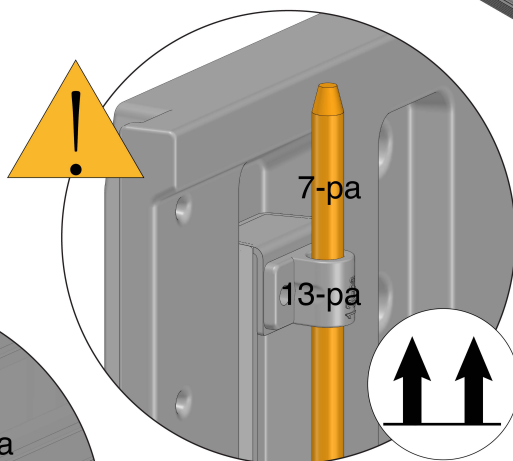
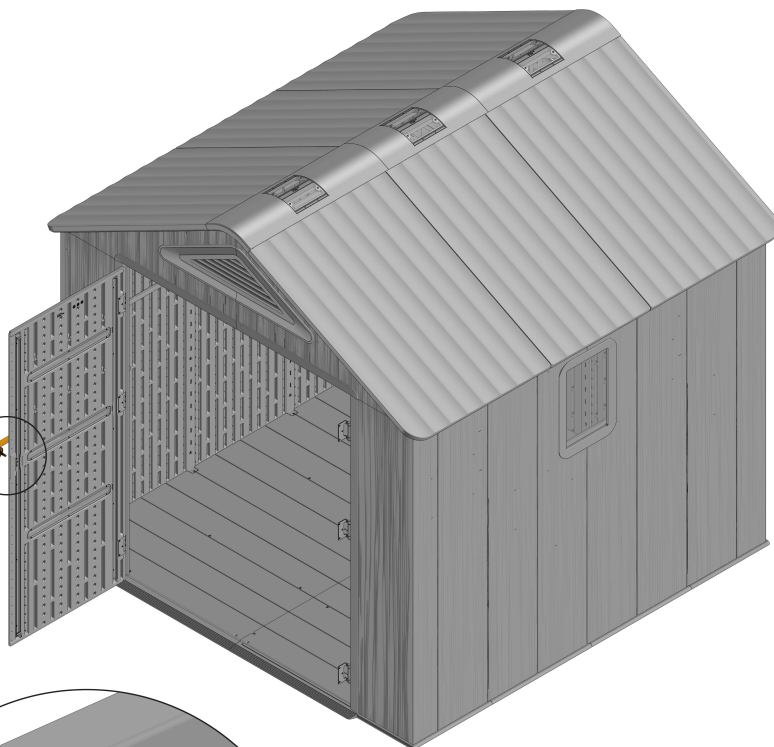
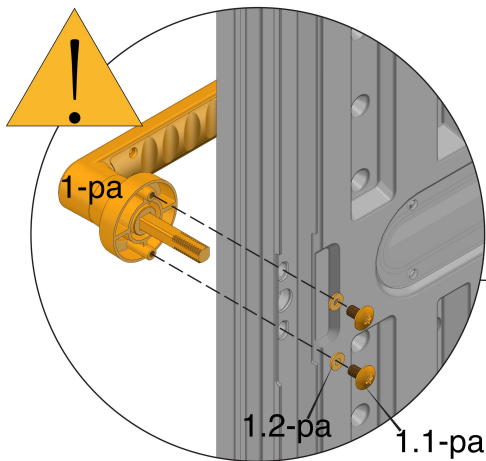

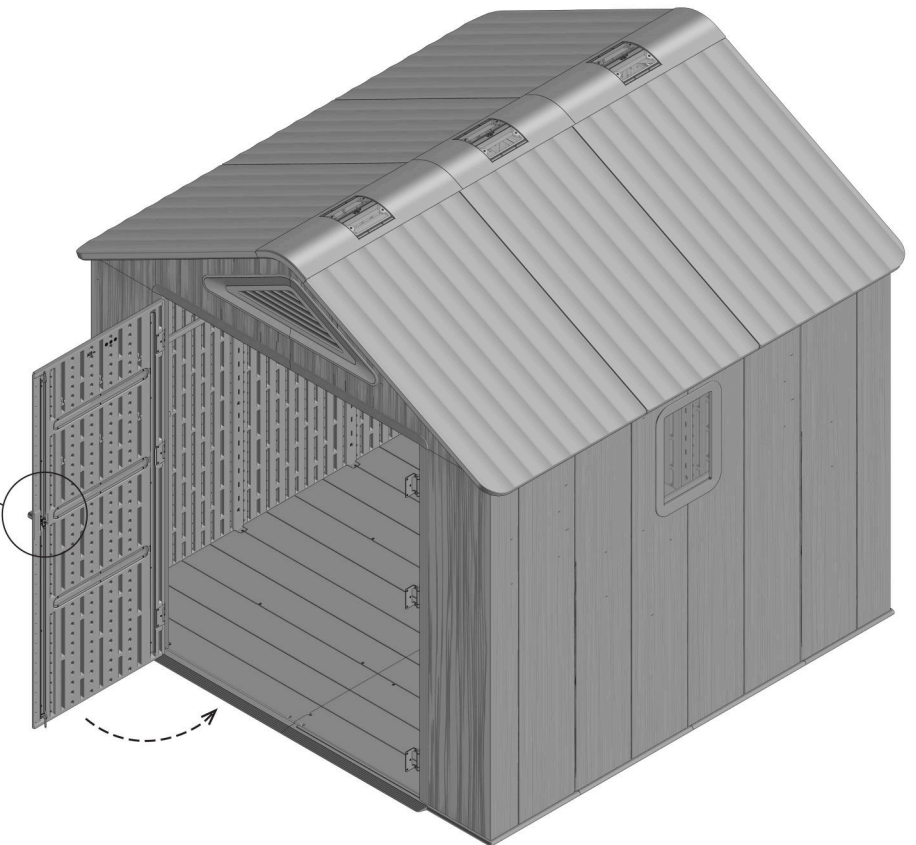
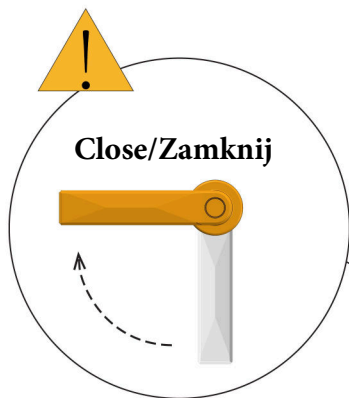
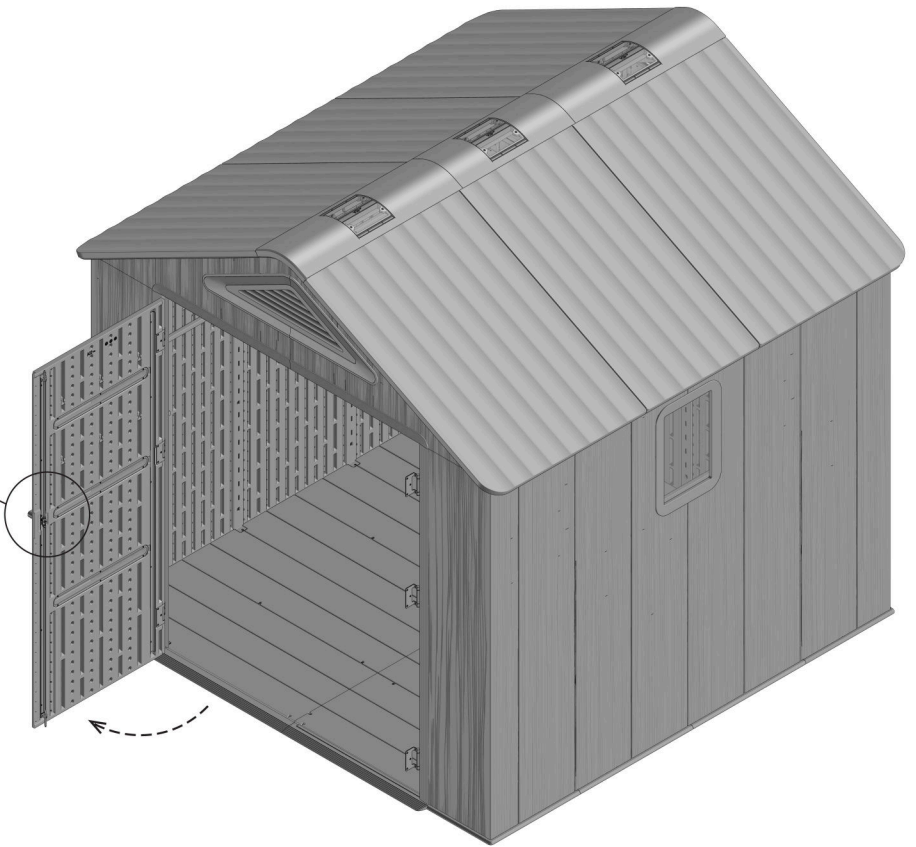
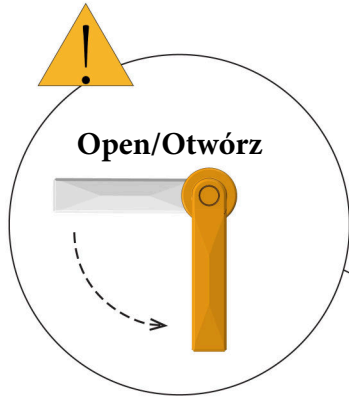

35



B53-pa x9

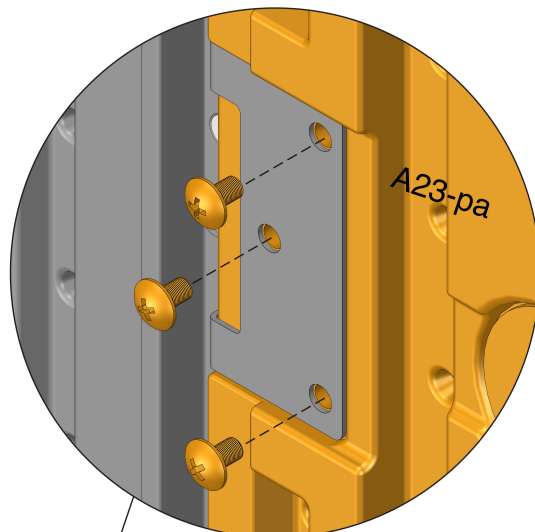
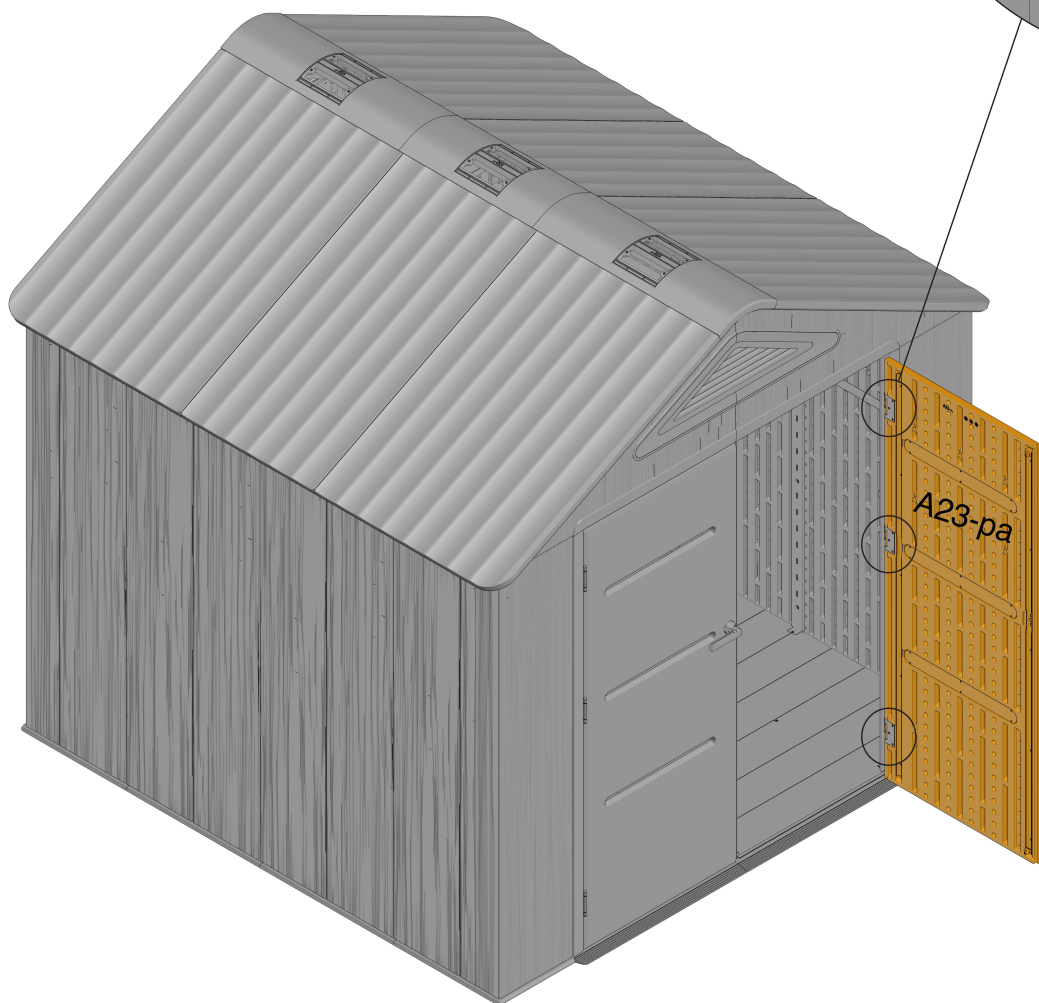

36



2-pa x1



1.1-pa x2



1.2-pa x2

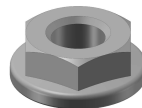

1.3-pa x1

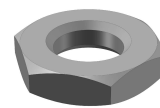

1.4-pa x1



1.5-pa x1

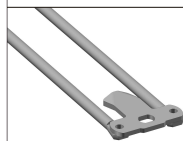

8-pa x1

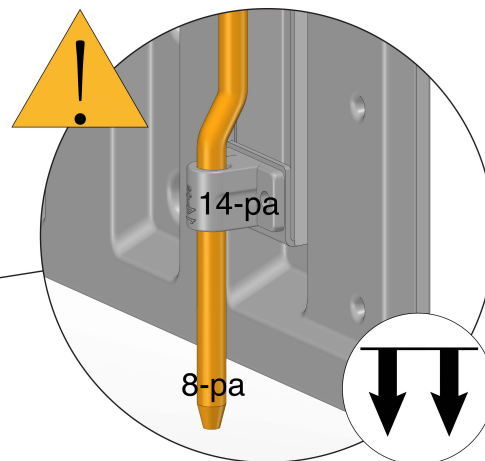
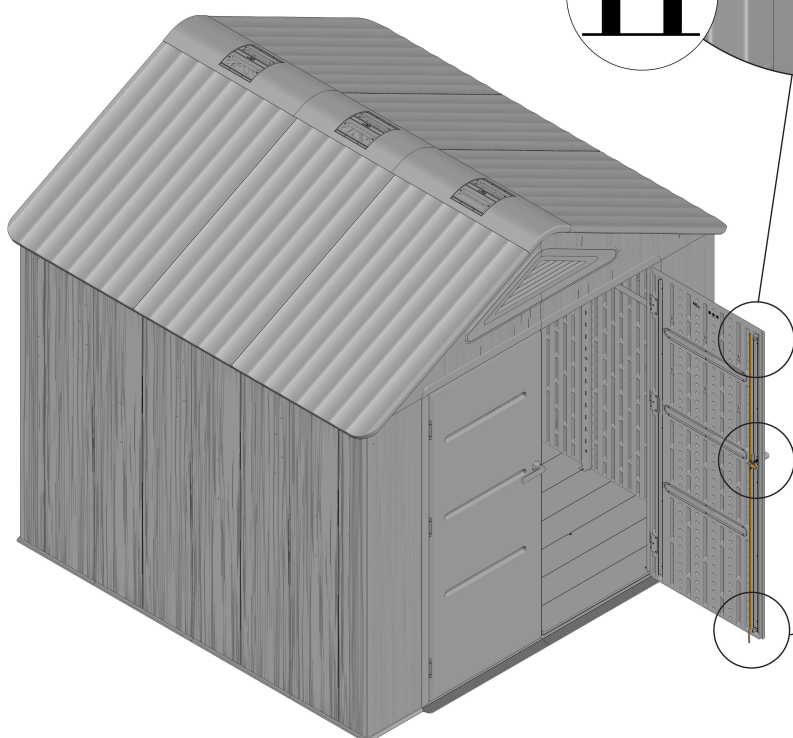
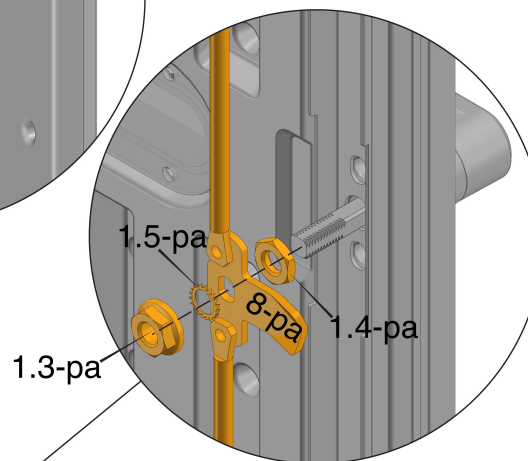
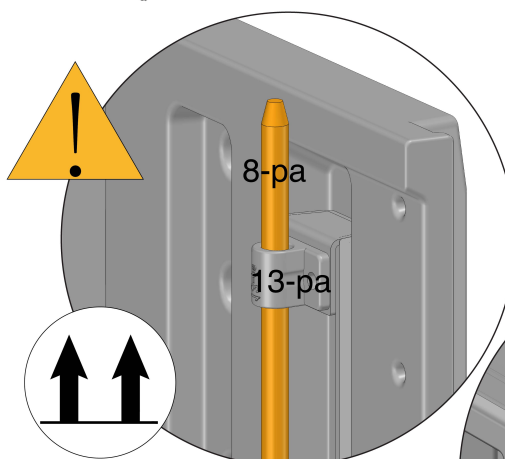
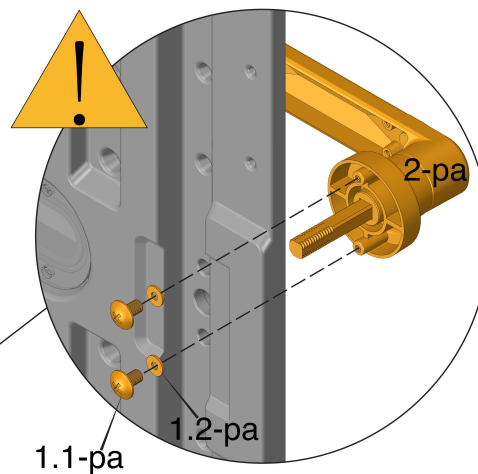
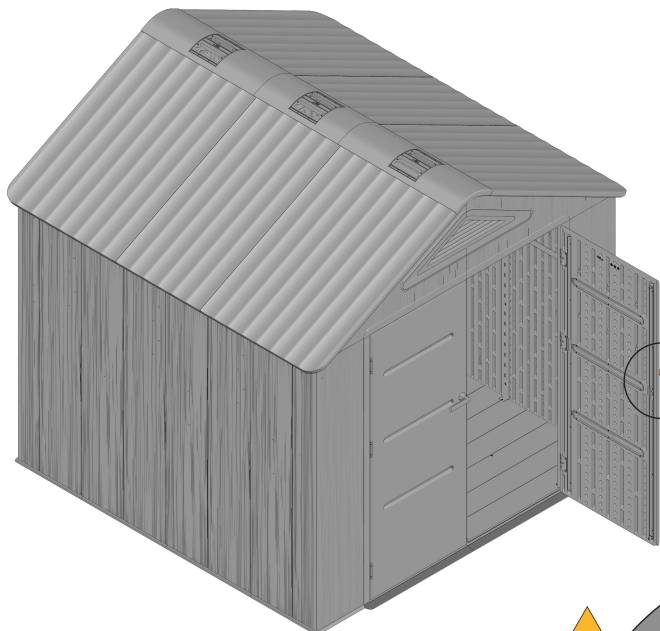

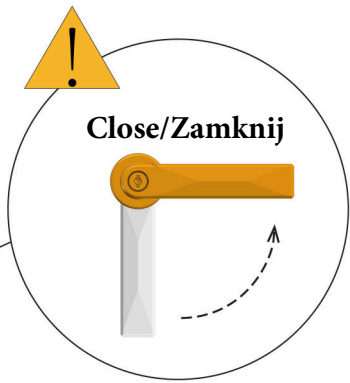
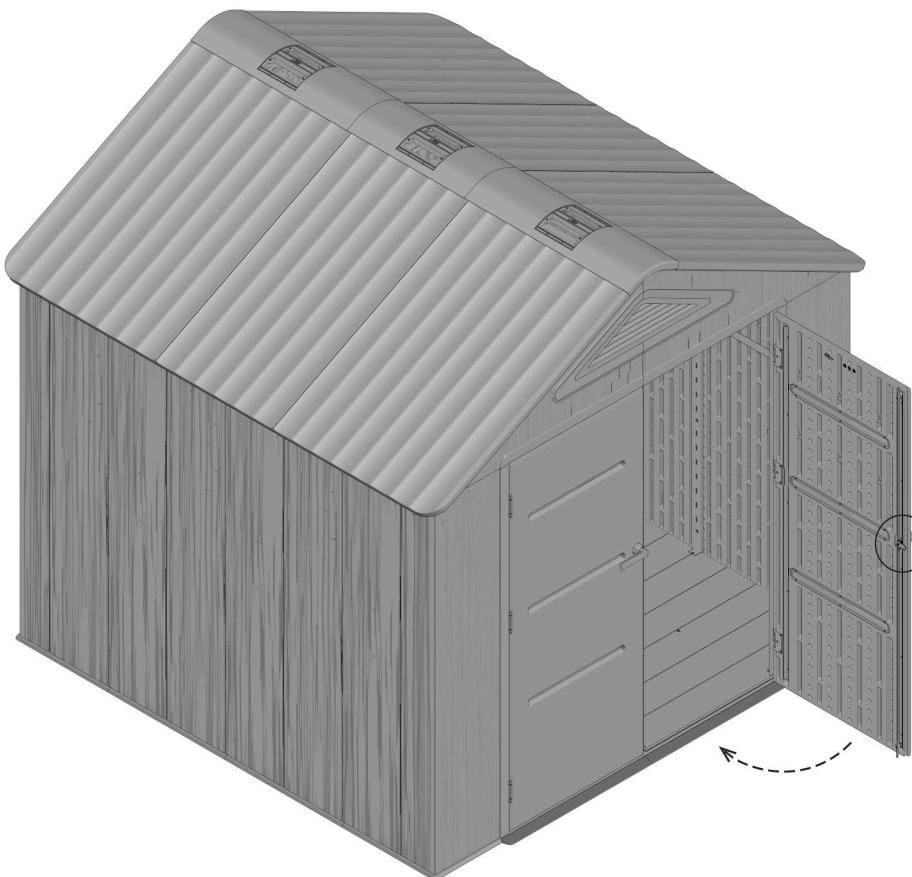
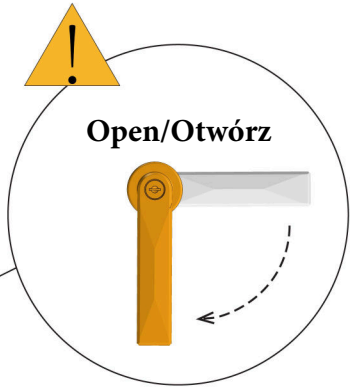
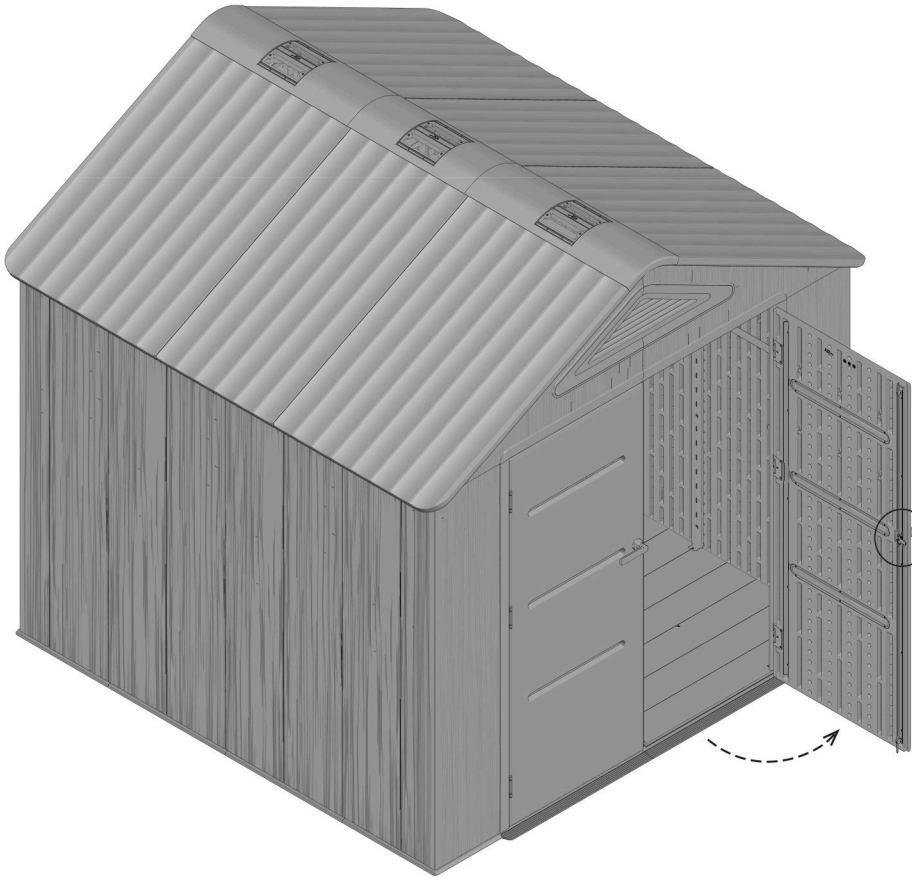

38



11-pa x5

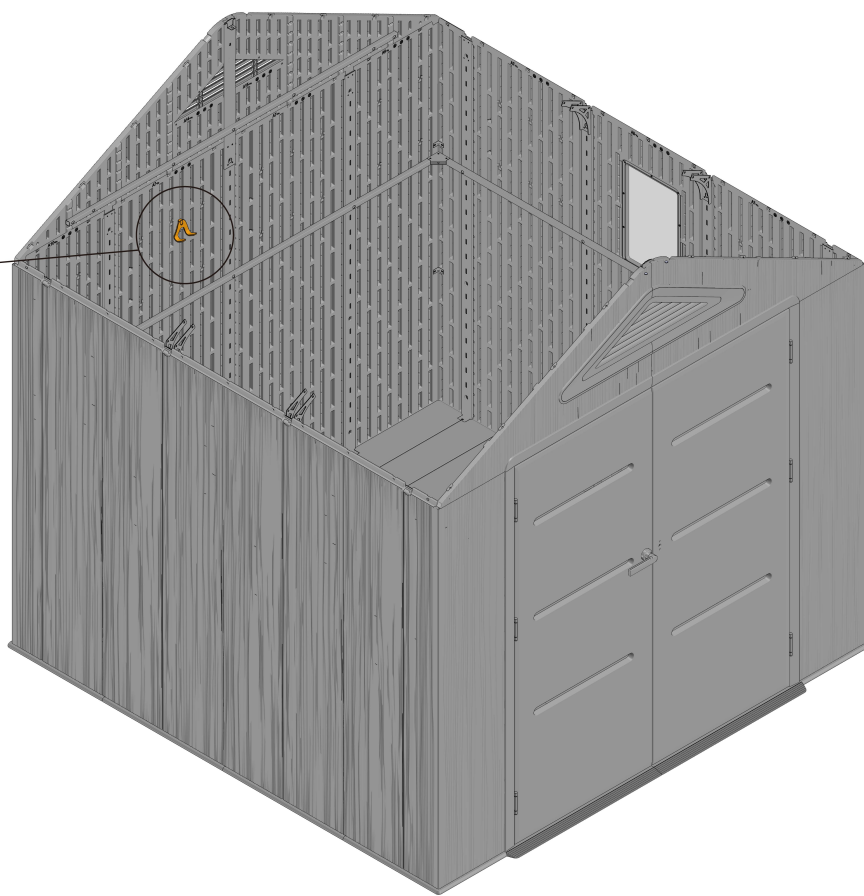
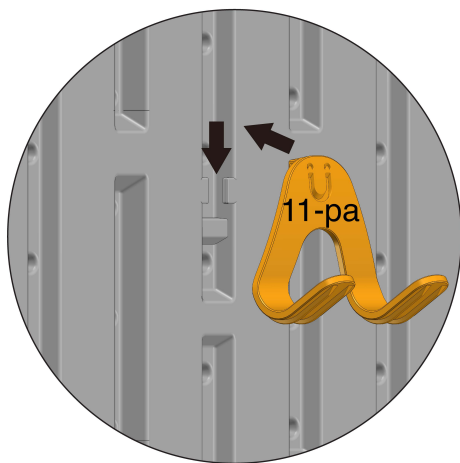
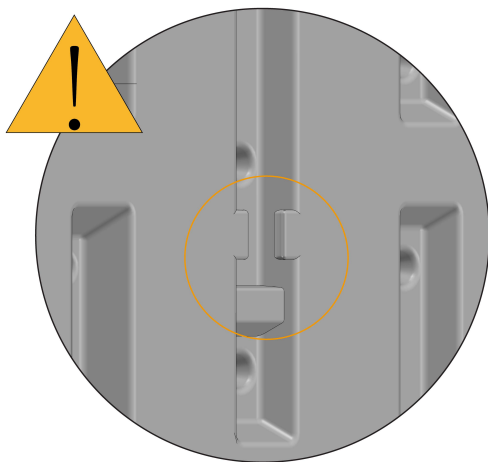

39

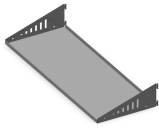

19-pa x2

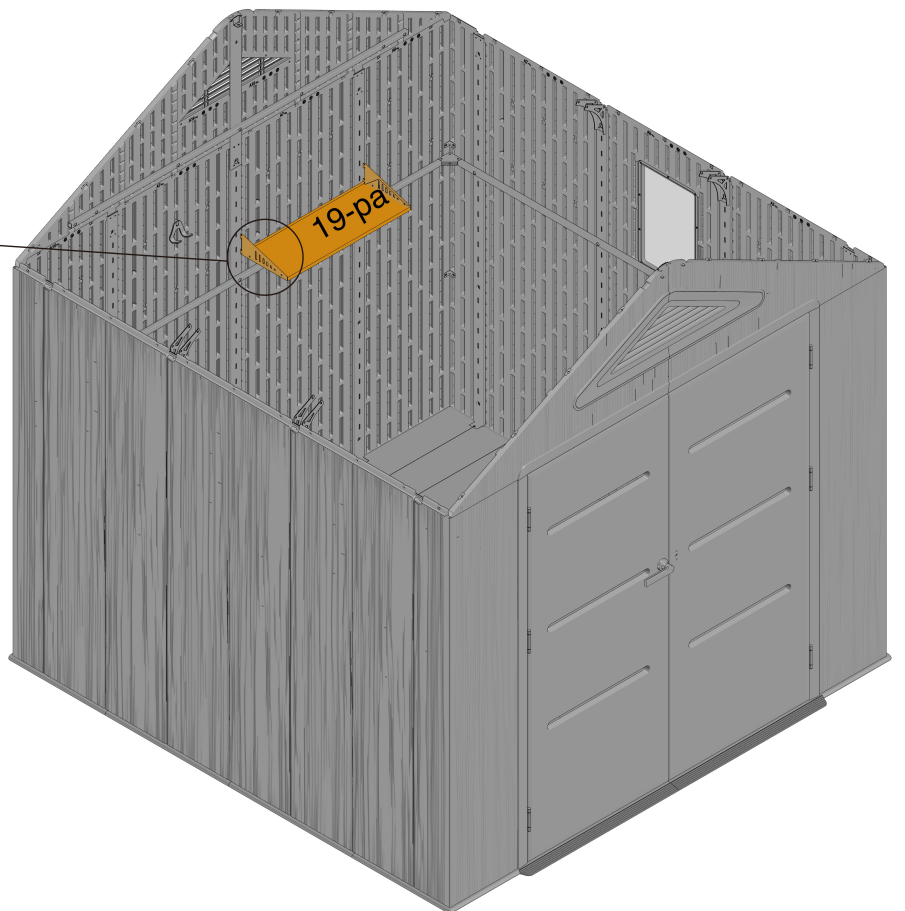
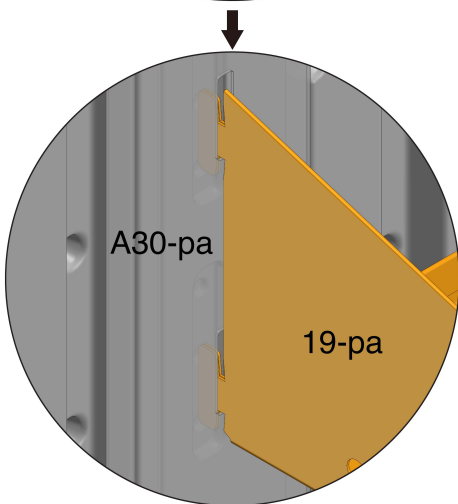
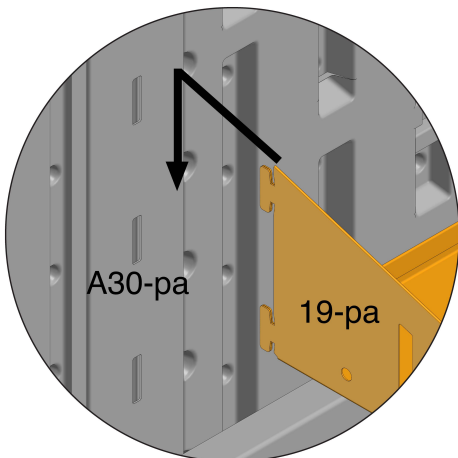
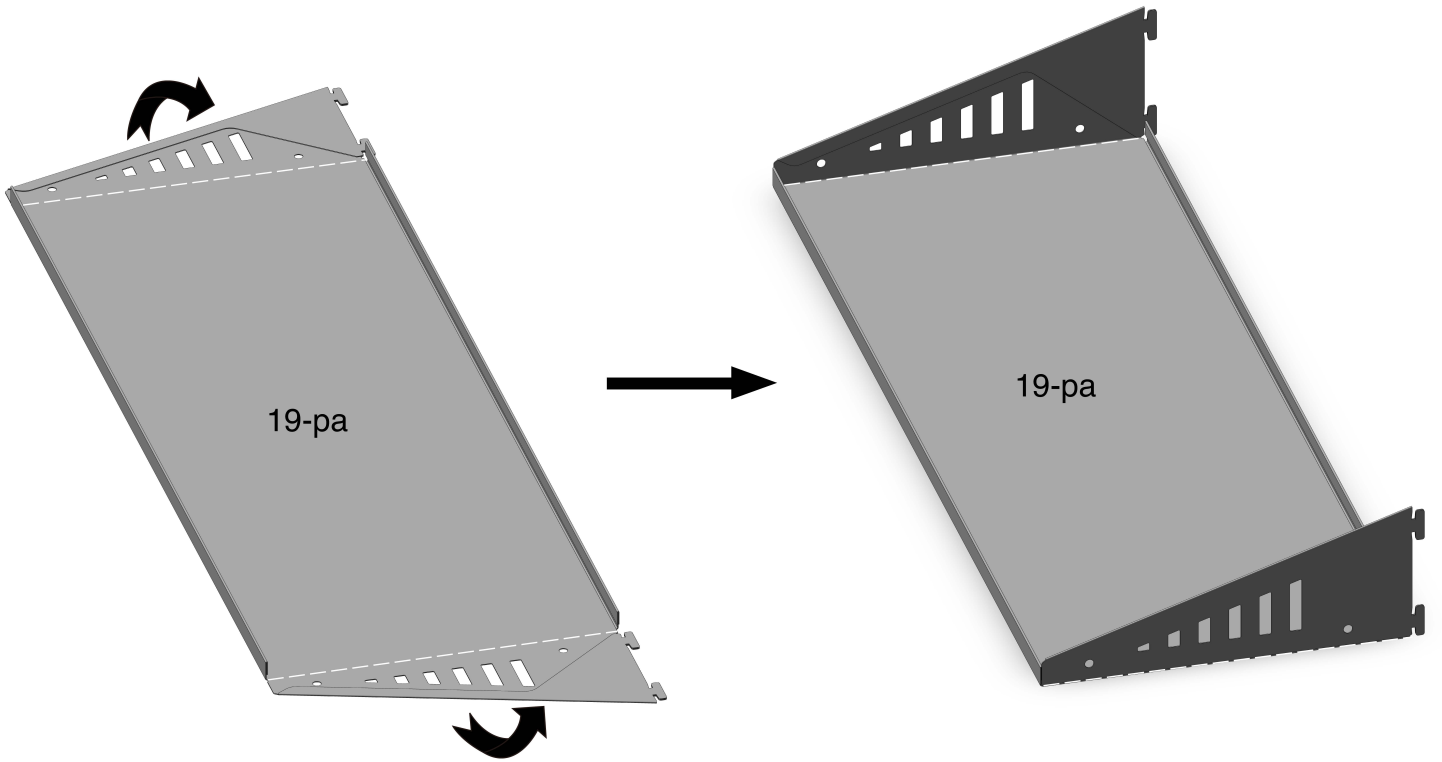

40



B60-pa x13

Montaż na drewnianej podstawie/
Assembly on a wooden base

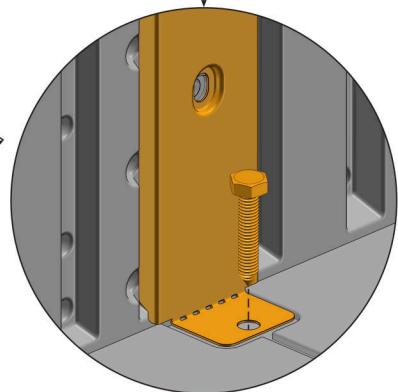
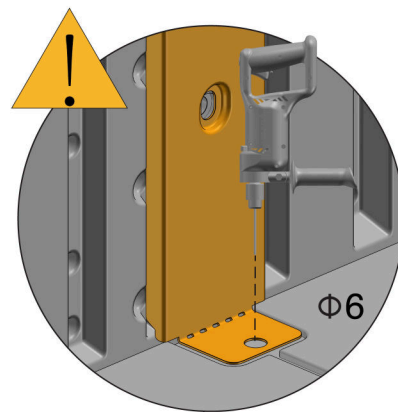
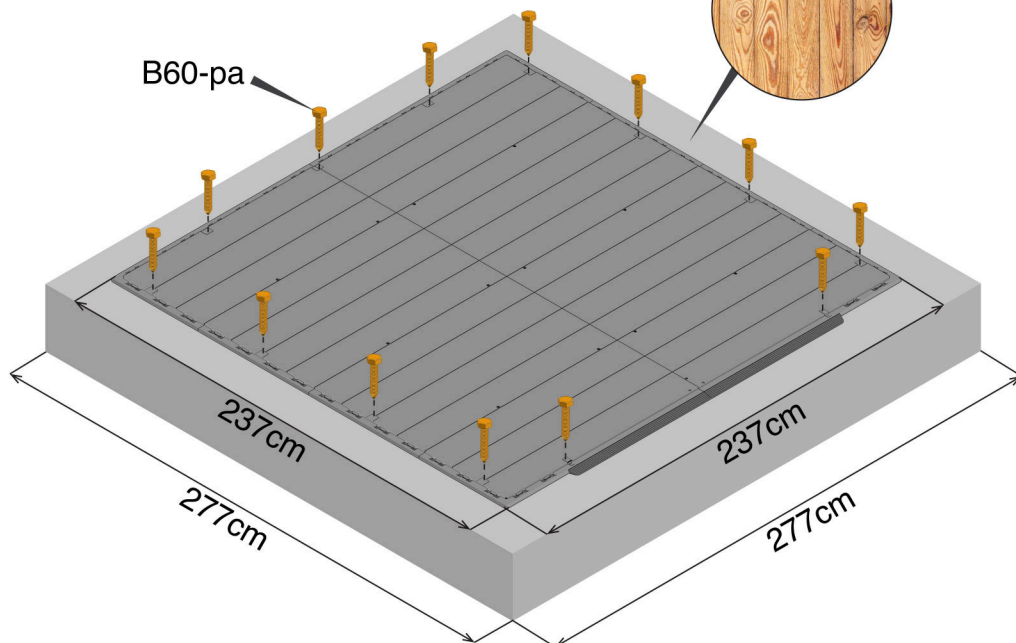

Montaż na betonowej podstawie/
Assembly on a concrete base

