

HARDMAISTER

Altana drewniana Wooden gazebo

Instrukcja montażu TIMBER 300x356
Assembly Instructions TIMBER 300x356

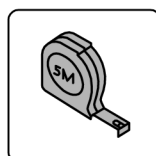
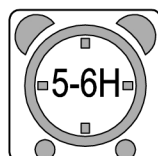
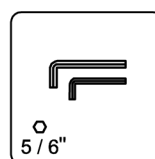
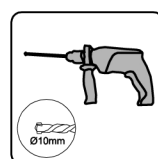
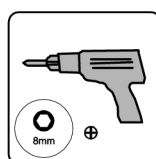
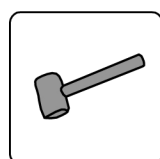
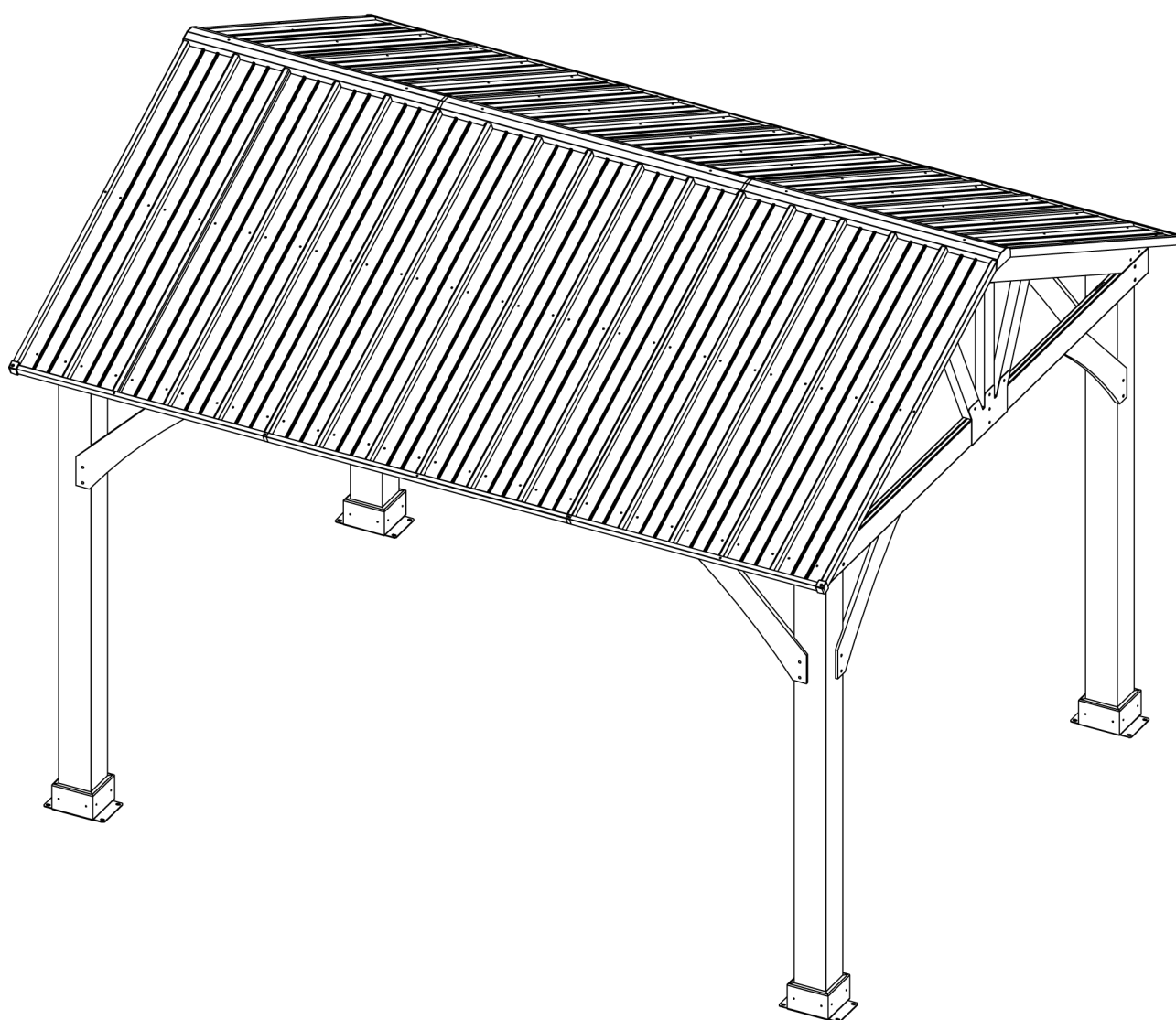

Przygotowanie do montażu

Instrukcja obsługi

Przed rozpoczęciem montażu należy sprawdzić lokalne przepisy budowlane dotyczące fundamentu, lokalizacji i innych wymagań.

Instrukcja montażu:

Przed rozpoczęciem prac przejrzyj wszystkie instrukcje i stosowne informacje. Upewnij się, że postępujesz krok po kroku, aby uzyskać pomyślne rezultaty.

Podstawa podłogi:

Przed rozpoczęciem montażu należy wybrać odpowiednie miejsce na altanę drewnianą, najlepszą lokalizacją jest czworokątny, równy, wypoziomowany teren z dobrym odpływem wody. Podstawy nie ma w zestawie, może wymagać zakupu osobno lub zbudowania własnego fundamentu i systemu kotwienia. Podstawa fundamentu powinna być o 10cm większa niż wymiary podstawy altany (zalecana jest płyta betonowa o grubości minimum 10cm). Pod fundamentem należy umieścić wytrzymałą warstwę z tworzywa sztucznego (grubość: co najmniej 150 µm), aby ograniczyć przenikanie wilgoci z gleby, zmniejszając tym samym gromadzenie się nawilgocenia wewnątrz. Altana drewniana musi być solidnie zakotwiczona, aby zapobiec uszkodzeniom powodowanym przez wiatr.

Lista części:

Zanim zaczniesz, upewnij się, że posiadasz wszystkie niezbędne części do budowy altany (patrz strona z listą części). Nie próbuj montować jeśli brakuje części, ponieważ każda altana pozostawiona częściowo zmontowana może zostać poważnie uszkodzona przez lekki wiatr.

Przed montażem należy oderwać warstwę ochronną, w razie potrzeby zachować etykietę z numerem części.

Potrzebne narzędzia:

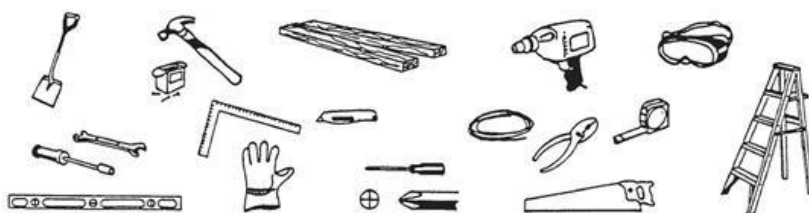

Bezpieczeństwo przede wszystkim:

1. Montaż altany drewnianej powinien się odbywać w suchy i spokojny dzień, nie należy podejmować pracy podczas niekorzystnych warunków pogodowych. Przy montażu altany powinny brać udział co najmniej dwie osoby. Zaleca się zakończyć montaż w jeden dzień, aby uniknąć uszkodzenia produktu lub zagubienia niektórych małych części. Wszystkie drobne części (śruby itp.) przechowuj w naczyniu, aby się nie pogubiły.

2. Aby zapobiec obrażeniom, podczas montażu konieczne jest noszenie rękawic ochronnych, okularów ochronnych i odzieży roboczej z długim rękawem. Należy zwrócić szczególną uwagę na ostre krawędzie niektórych elementów altany i zachować szczególną ostrożność podczas manewrowania nimi i montażu.
3. Zabrania się wstępu na teren budowy dzieci, osób niepełnoletnich, osób niepełnosprawnych, osób nietrzeźwych lub pod wpływem środków odurzających oraz zwierząt.
4. Nigdy nie wolno obciążać dachu budynku całkowitą masą ciała. Korzystając z drabiny schodkowej, należy upewnić się, że jest bezpieczna i ustawiona na płaskim podłożu.

Pielęgnacja i konserwacja:

1. Utrzymuj altanę w czystości używając miękkiej ściereczki, w razie potrzeby z dodatkiem wody.
2. Oczyść altanę ze śniegu za pomocą niezbędnych narzędzi.

Assembly Preparation

Owner's Manual

Please check local building codes regarding footings, location and other requirements before beginning construction.

Assembly instructions:

Reviewing all instructions and the appropriate information before you begin, make sure following the step sequence carefully for successful results.

Flooring base:

A good location for the wooden gazebo is a square and level area with good drainage. The base is not included in the kit which may need purchase separately or may construct a foundation and anchoring system of your own. The foundation base should be 10 cm larger than the base rail of the shed (minimum 10cm thickness concrete slab is recommended).

A strong plastic sheet (thickness: at least 150µm) should be placed under the foundation to assist in reducing rising dampness from the soil, thus reducing condensation build up in the shed. Your wooden gazebo must be anchored to prevent wind damage.

Parts and Parts List:

Before you start, check to be sure that you have all the necessary parts for your building (refer to the Parts List Page). Do not attempt to assemble the building if parts are missing because any building left partially assembled may be seriously damaged by light winds.

Please tear off the safety protection layer before assembly, keep the part number label if needed.

Tools you need:

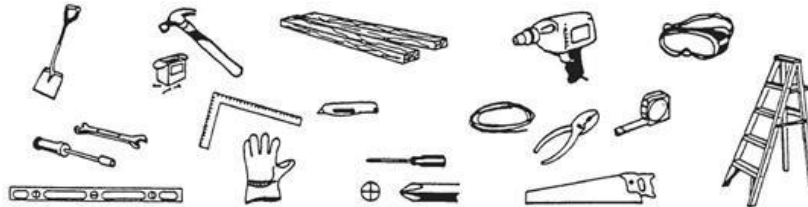

Safety must be put in the No. 1 position:

1. Select a dry and calm day for your assembly. Team works (Two or more people) are required during the assembly. It is also recommended to finish the assembly in a day to avoid damage to the product or missing of some small parts. Keep all small parts (screws etc.) in a bowl so they do not get lost.
2. Wearing safety gloves, eye protection and long sleeves during the assembly to prevent injury. Pay attention to the sharp edge of some parts.
3. Children and pets are not allowed entering into the construction site.
4. Never concentrate your total weight on the roof of the building. When using a step ladder make sure that it is safe.

Care & Maintenance:

1. Keep the shed clean with soft cloth, use water if necessary.
2. Clear the arbour of snow using the necessary tools.

3.56x3.00x2.82m
10.68m²

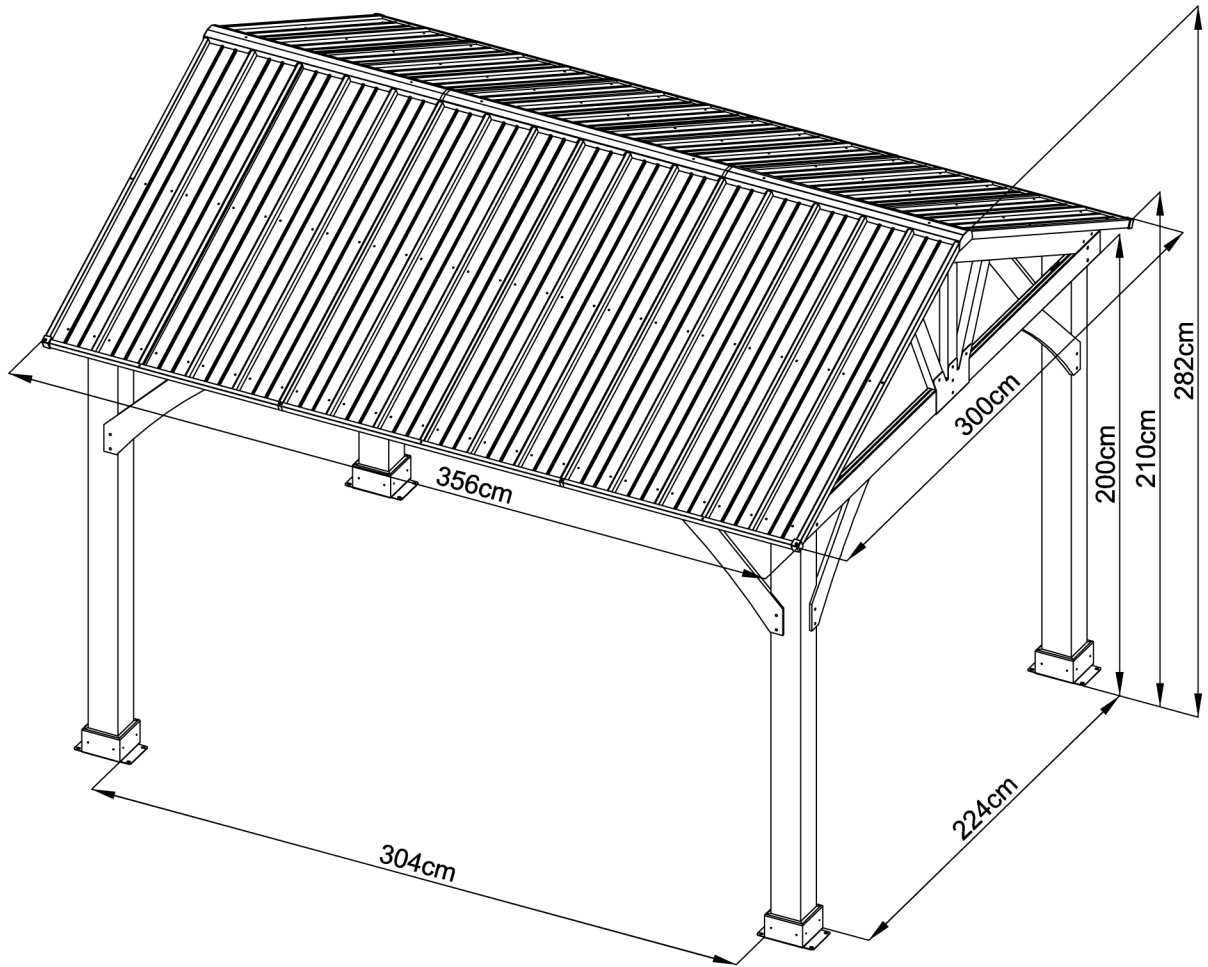

Wymagana powierzchnia podstawy:
Area of installation requirement:

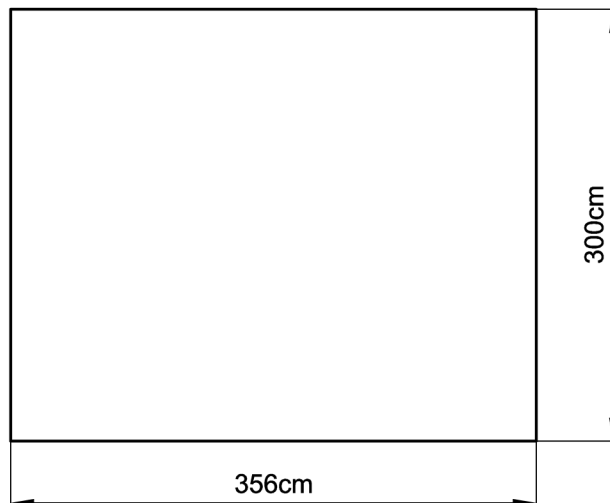

TIMBER 300x356:

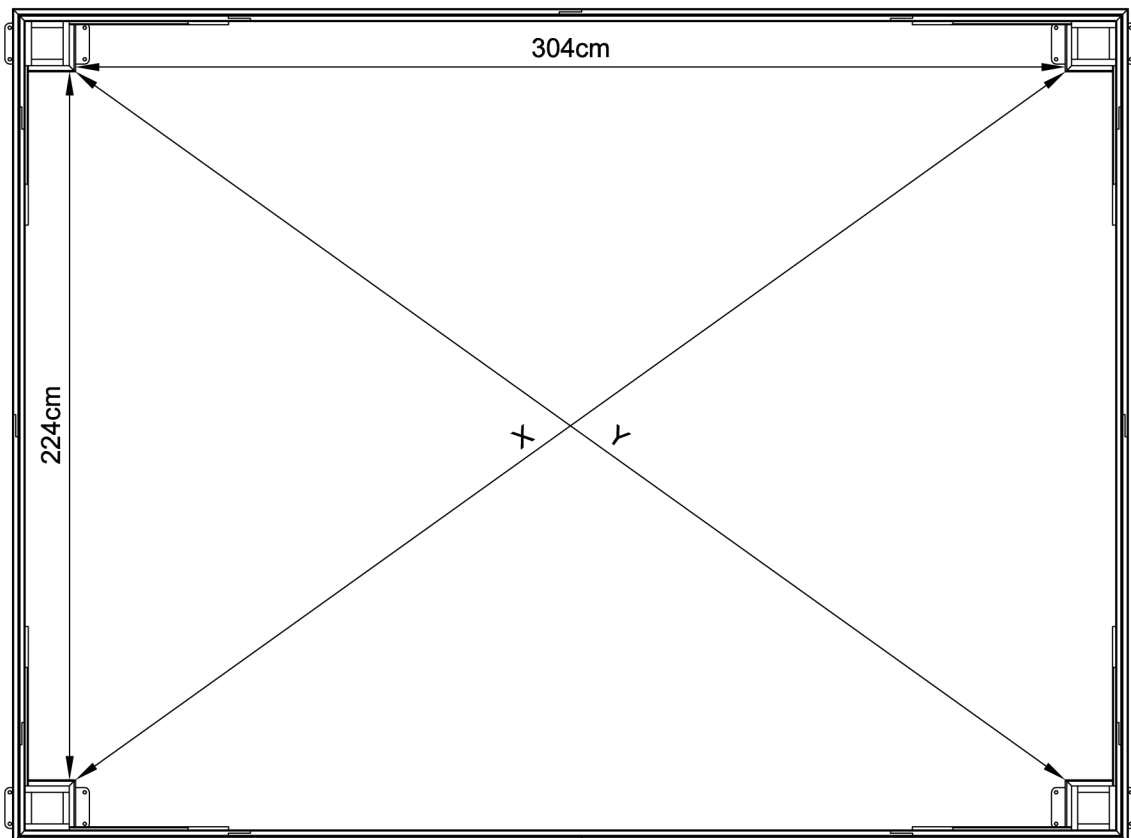

$$X=Y \pm 2CM$$

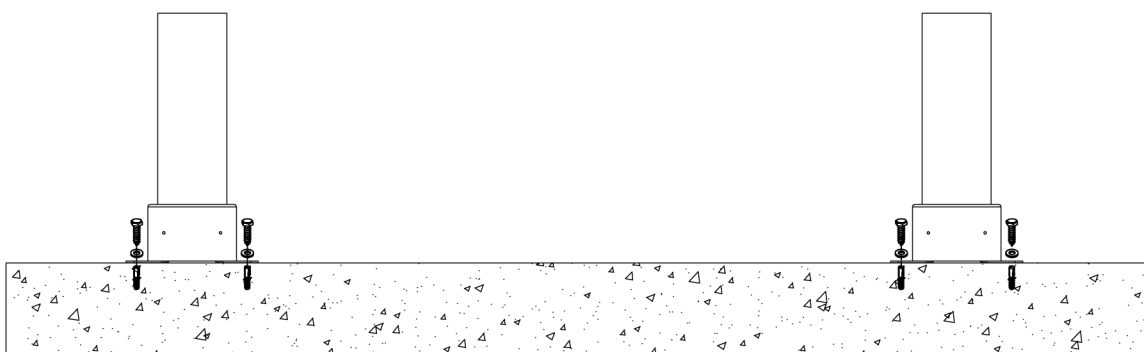

TIMBER 300x356:

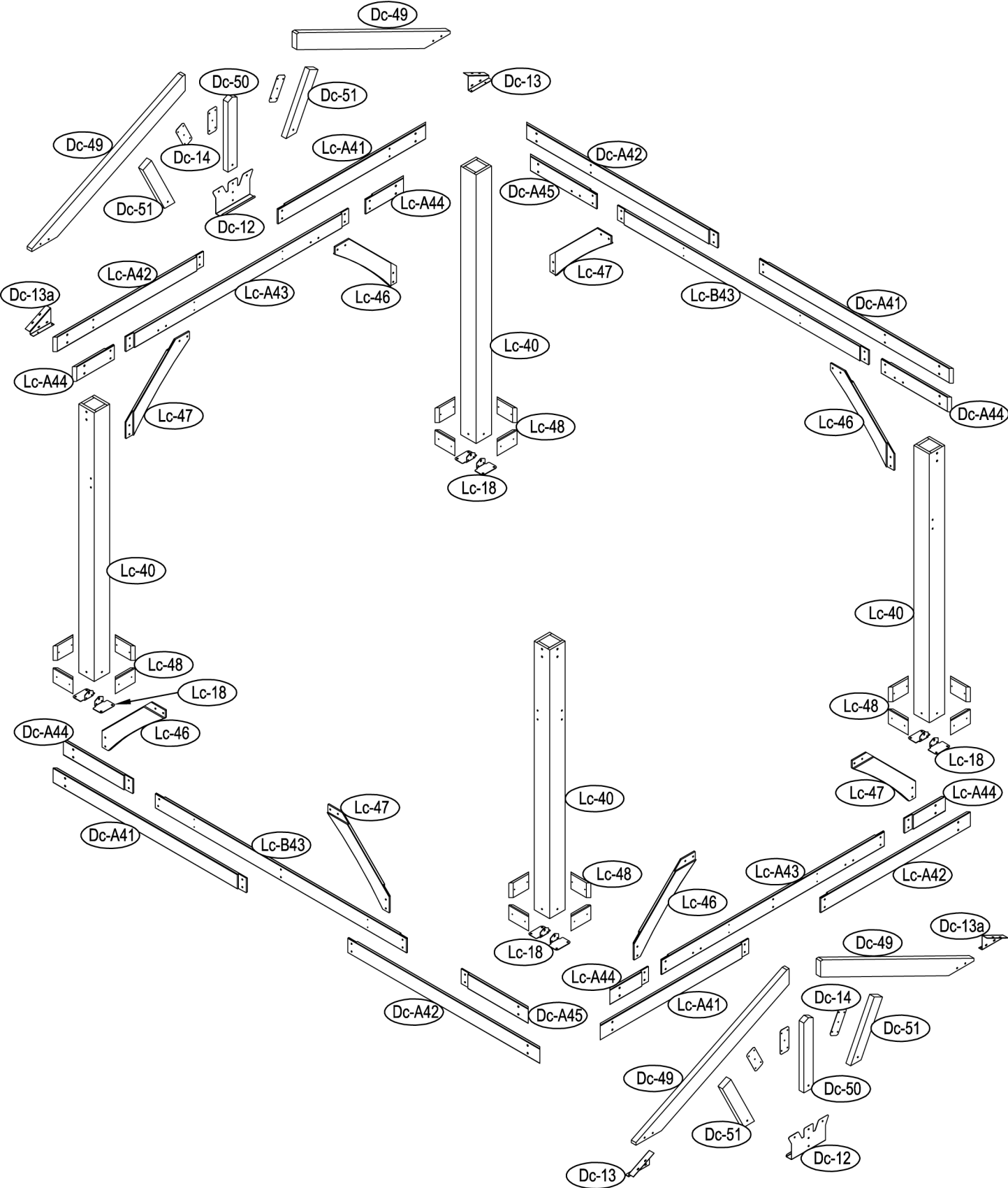

TIMBER 300x356:

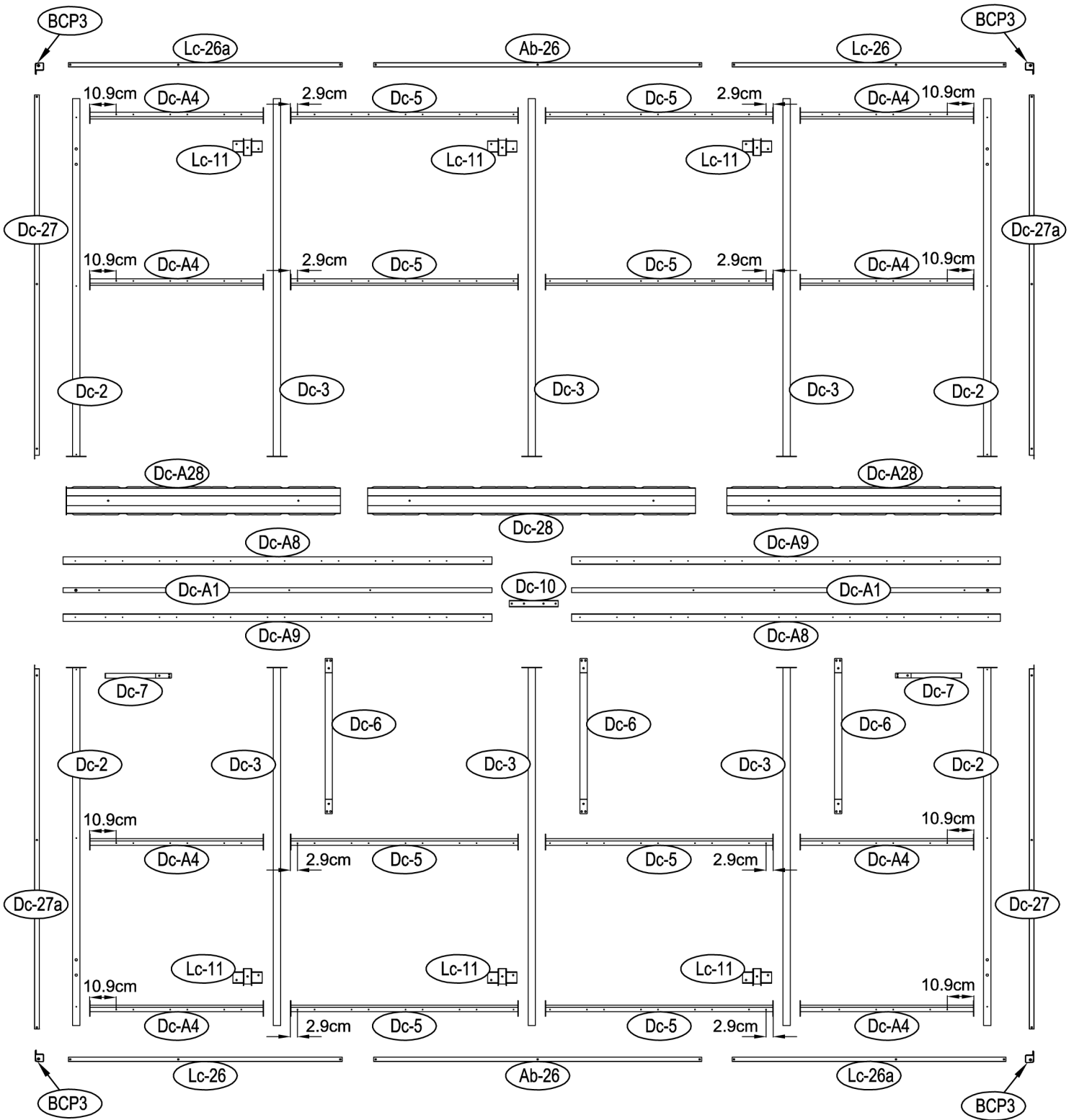





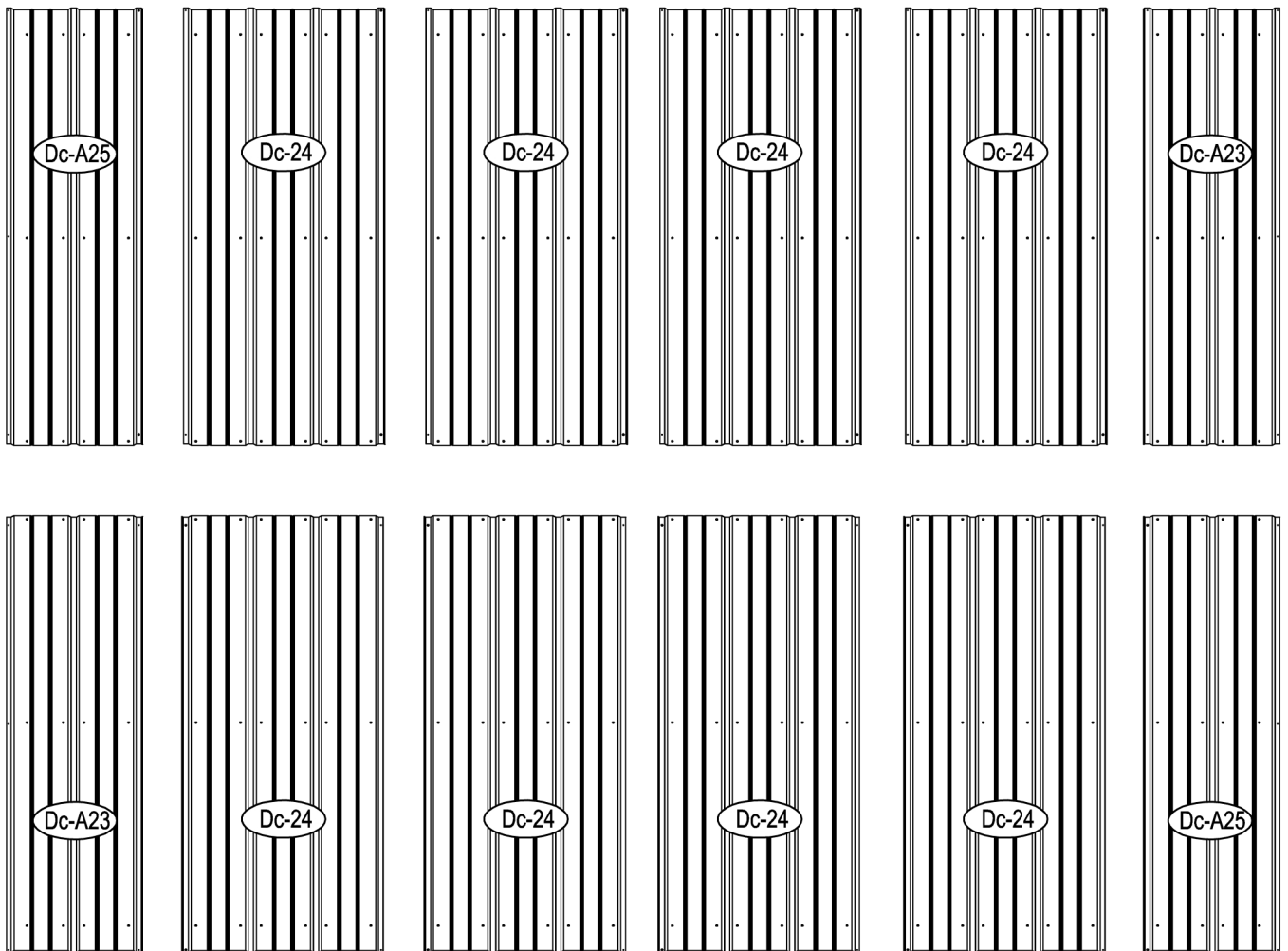



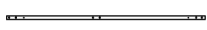















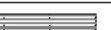





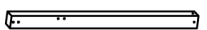





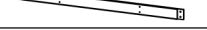

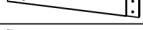

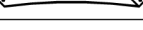



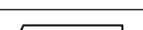









**ROOF 1
DACH 1**

TIMBER 300x356:

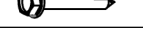
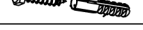

ROOF 2
DACH 2

NO./NR.	IMAGE/ZDJĘCIE	L./DŁ.(mm)	QTY/SZT.
Dc-A1		1760	x2
Dc-2		1637	x4
Dc-3		1637	x6
Dc-A4		714	x8
Dc-5		935	x8
Dc-6		637	x3
Dc-7		385	x2
Dc-A8		1760	x2
Dc-A9		1760	x2
Dc-10		200	x1
Lc-11			x6
Dc-12			x2
Dc-13			x2
Dc-13a			x2
Dc-14			x6
Lc-18		160	x8
Dc-A23		1650	x2
Dc-24		1650	x8
Dc-A25		1650	x2
Ab-26		1345	x2
Lc-26		1123.5	x2
Lc-26a		1123.5	x2
Dc-27		1647	x2
Dc-27a		1647	x2
Dc-28		1345	x1
Dc-A28		1125	x2



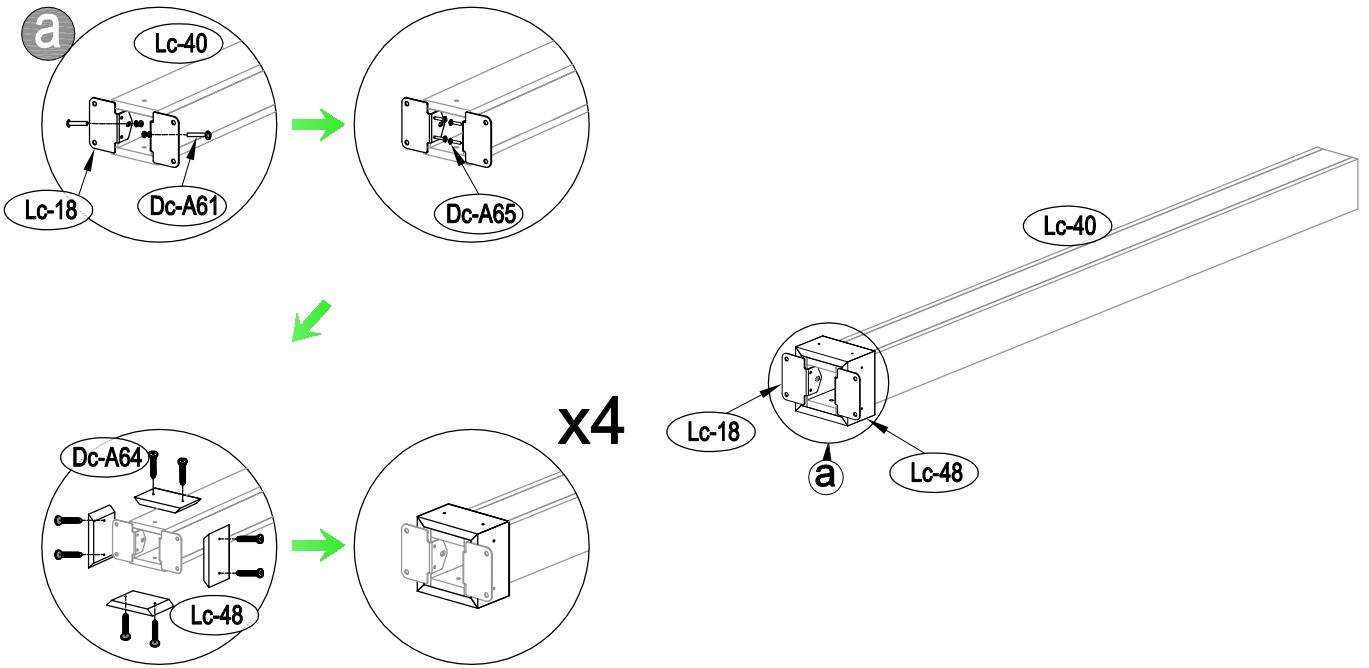

NO./NR.	IMAGE/ZDJĘCIE	L./DŁ.(mm)	QTY/SZT.
Lc-40		2110	x4
Lc-A41		1356	x2
Dc-A41		1757	x2
Lc-A42		1356	x2
Dc-A42		1757	x2
Lc-A43		2020	x2
Lc-B43		1920	x2
Lc-A44		362	x4
Dc-A44		812	x2
Dc-A45		812	x2
Lc-46		800	x4
Lc-47		800	x4
Lc-48		180	x16
Dc-49		1477	x4
Dc-50		541	x2
Dc-51		460	x4
BCP3			x4
Dc-A58		M6	x116
Dc-A59		M8	x16
Dc-A60		M10x60	x16
Dc-A61		M8x40	x8
Dc-A62		M8x35	x24
Dc-A63		M8x25	x32
Dc-A64		M5x35	x70
Dc-A65		ST4x16	x58
Dc-A66		ST4x10	x252
Dc-A67		M6x45	x46
Dc-A68		M6x35	x12
Dc-A69		ST4.8x35	x6
Dc-A70		M8x60	x16
Dc-A71		M4	x220
Dc-A72		M6	x58
Dc-A73		M8	x86
Dc-A74		M10	x16
Dc-A75		M8x50	x14

<p>1</p>	<p>Lc-40 [x4]</p>	<p>Lc-48 [x16]</p>	<p>Lc-18 [x8]</p>	<p>Dc-A61 [x8] M8X40</p>	<p>Dc-A64 [x32] M5X35</p>	<p>Dc-A65 [x16] ST4X16</p>
-----------------	-------------------	--------------------	-------------------	--------------------------	---------------------------	----------------------------

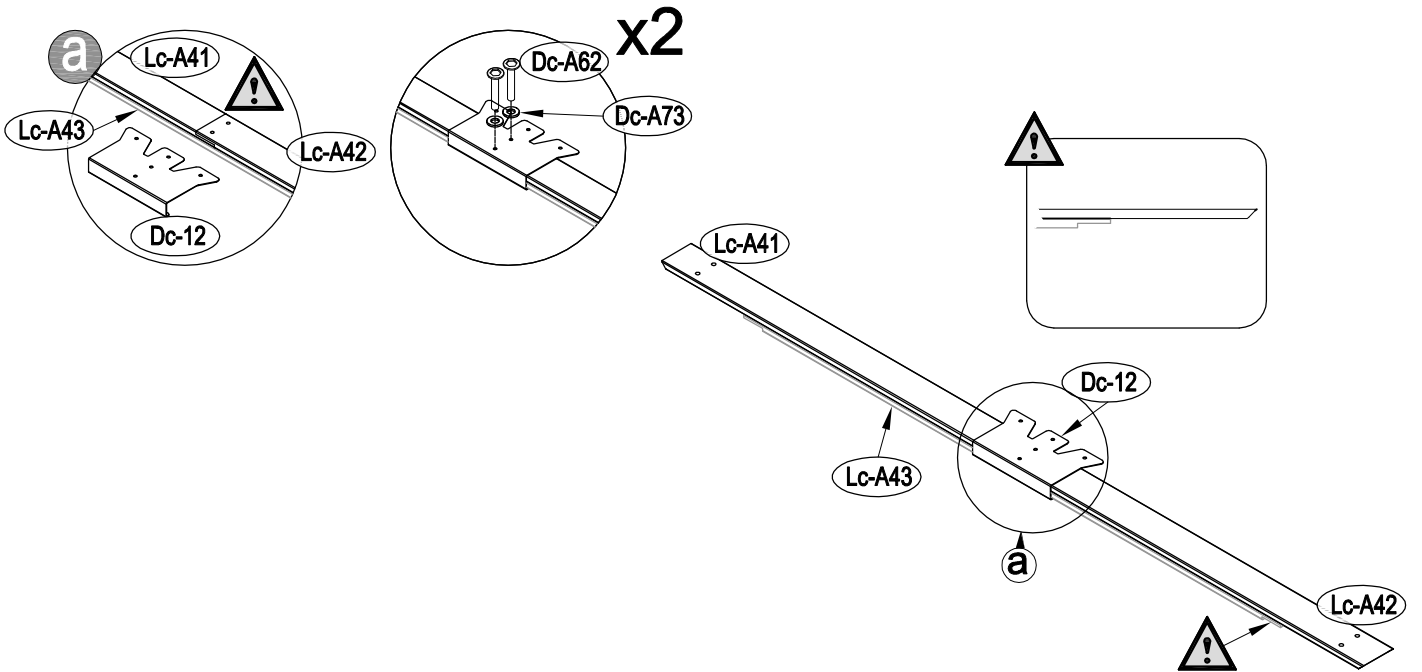

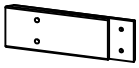

<p>2</p>	<p>Lc-A41 [x2]</p>	<p>Lc-A42 [x2]</p>	<p>Lc-A43 [x2]</p>	<p>Dc-12 [x2]</p>	<p>Dc-A62 [x4] M8X35</p>	<p>Dc-A73 [x4] M8</p>
-----------------	--------------------	--------------------	--------------------	-------------------	--------------------------	-----------------------

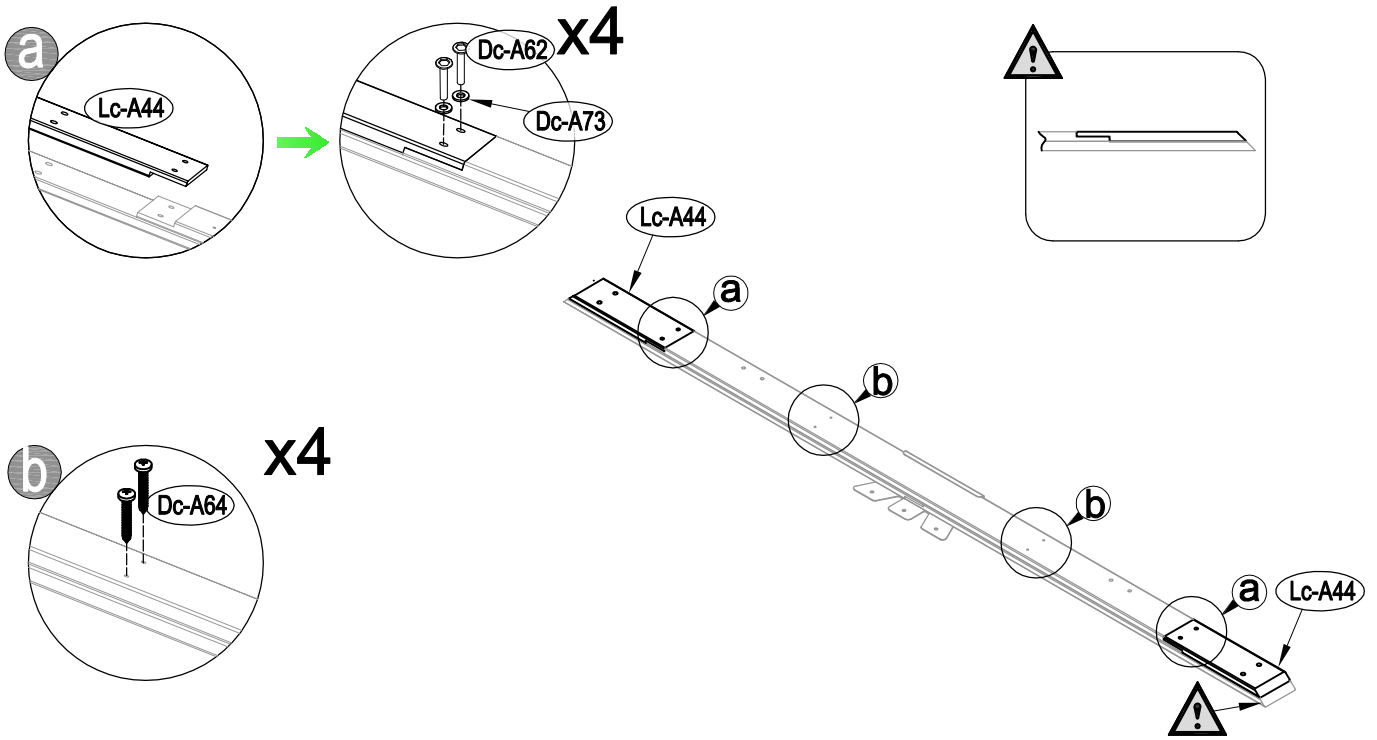

3	 Lc-A44 [x4]	 Dc-A62 [x8] M8X35	 Dc-A64 [x8] M5X35	 Dc-A73 [x8] M8	
---	--	--	--	---	--

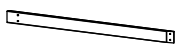
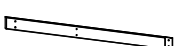
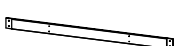

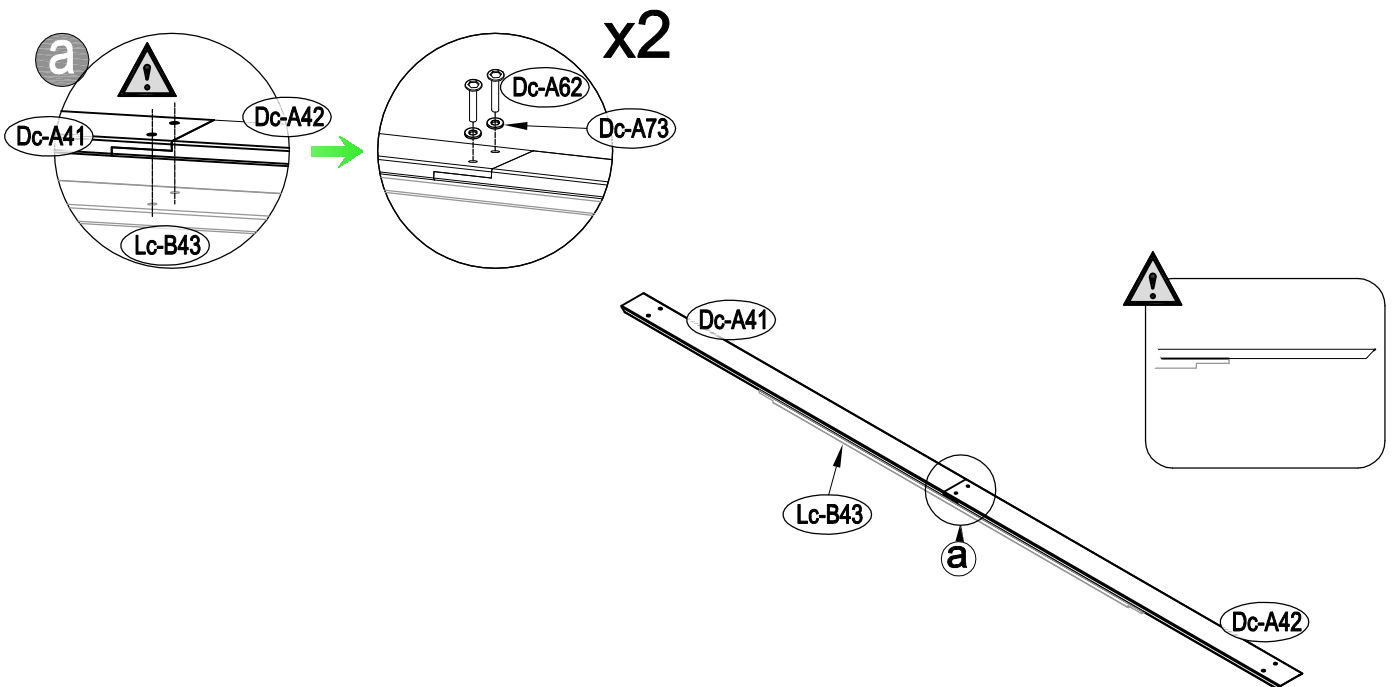

4	 Dc-A41 [x2]	 Dc-A42 [x2]	 Lc-B43 [x2]	 Dc-A62 [x4] M8X35	 Dc-A73 [x4] M8	
---	--	--	--	--	---	--



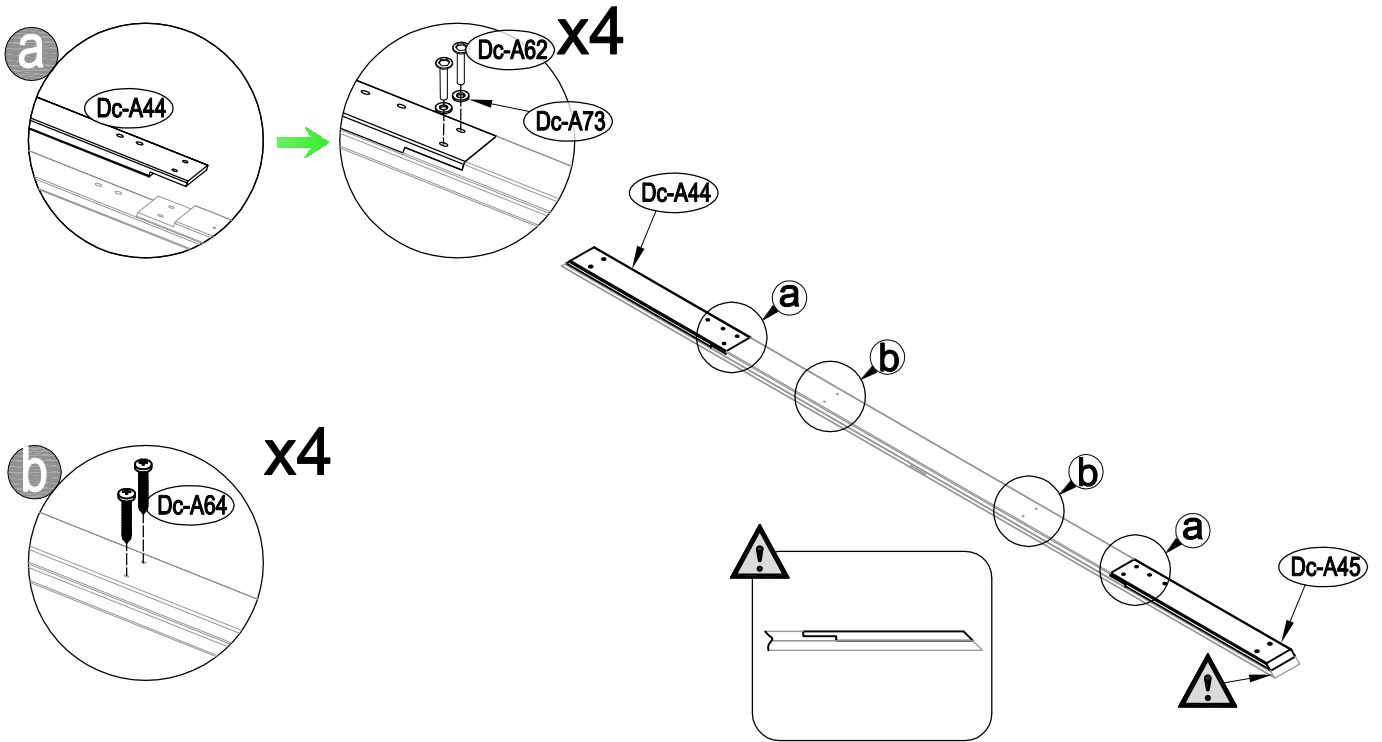

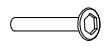
5	 Dc-A44 [x2]	 Dc-A45 [x2]	 Dc-A62 [x8] M8X35	 Dc-A64 [x8] M5X35	 Dc-A73 [x8] M8	
---	--	--	--	--	---	--



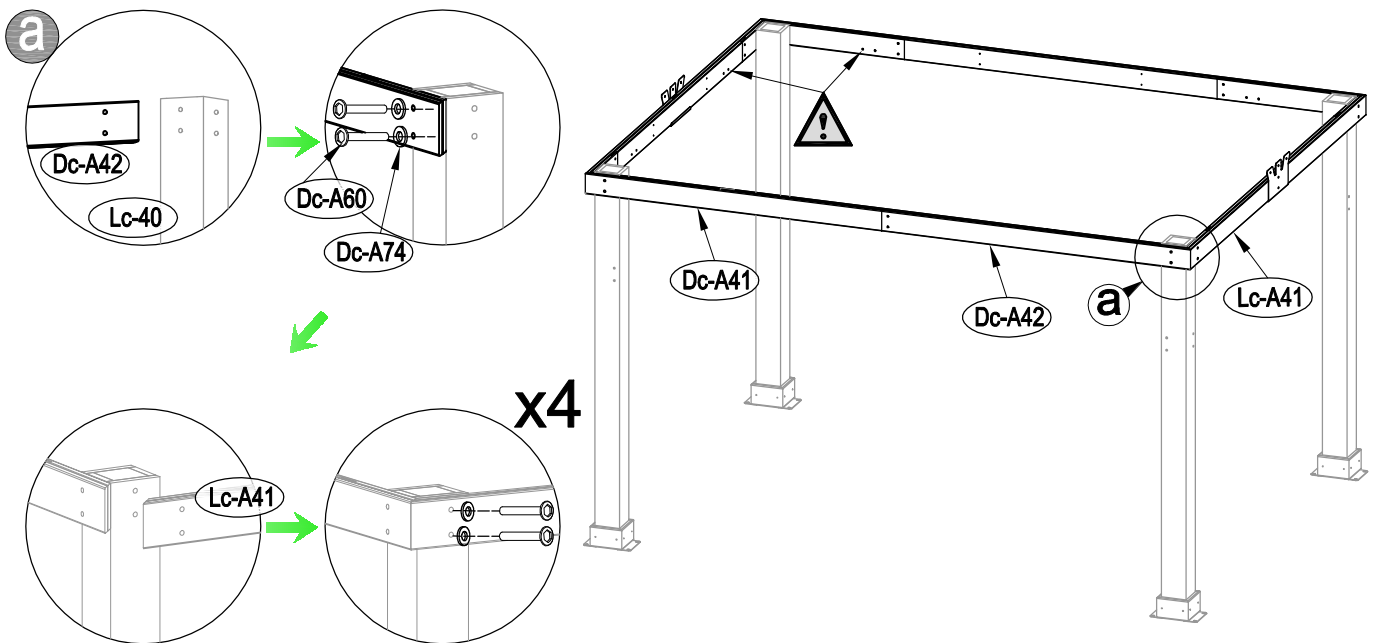

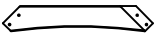
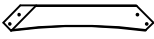
6	 Dc-A60 [x16] M10X60	 Dc-A74 [x16] M10	
---	--	---	--



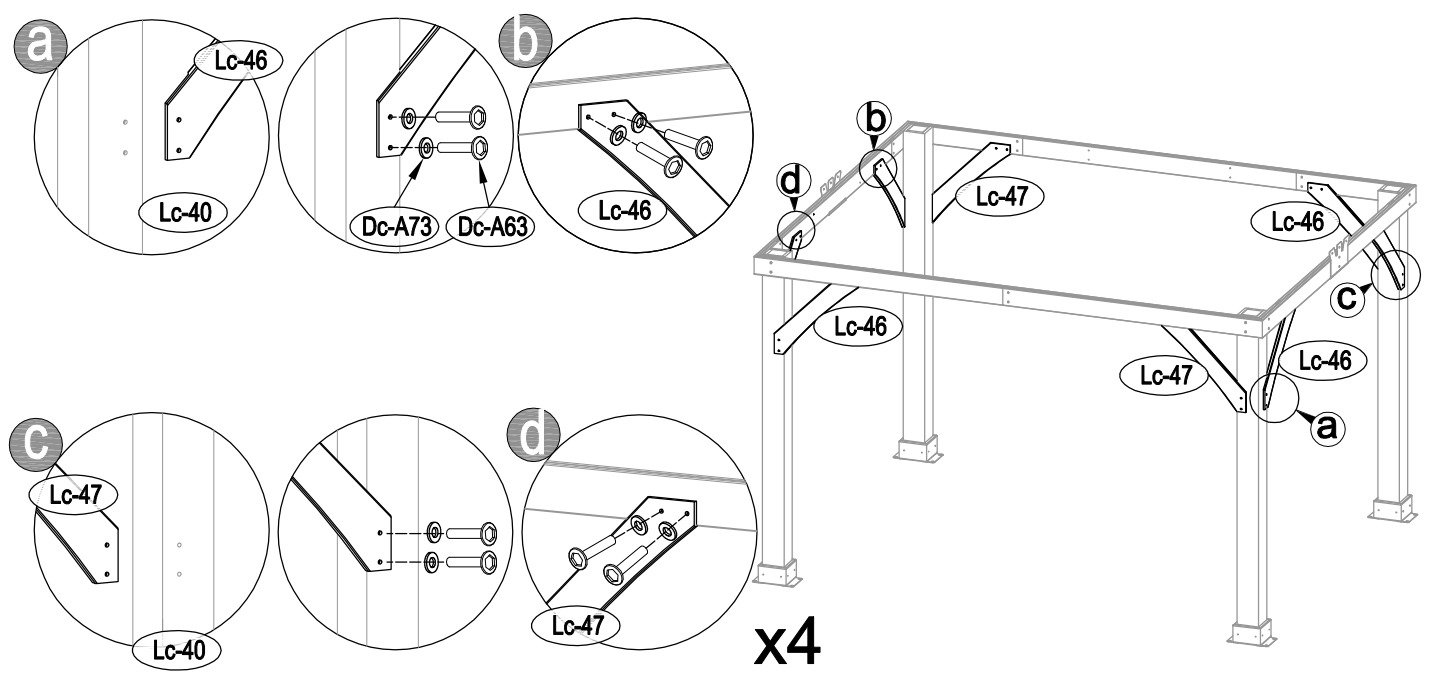

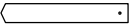
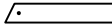

7	 Lc-46 [x4]	 Lc-47 [x4]	 Dc-A63 [x32] M8X25	 Dc-A73 [x32] M8	
----------	---	---	---	---	--

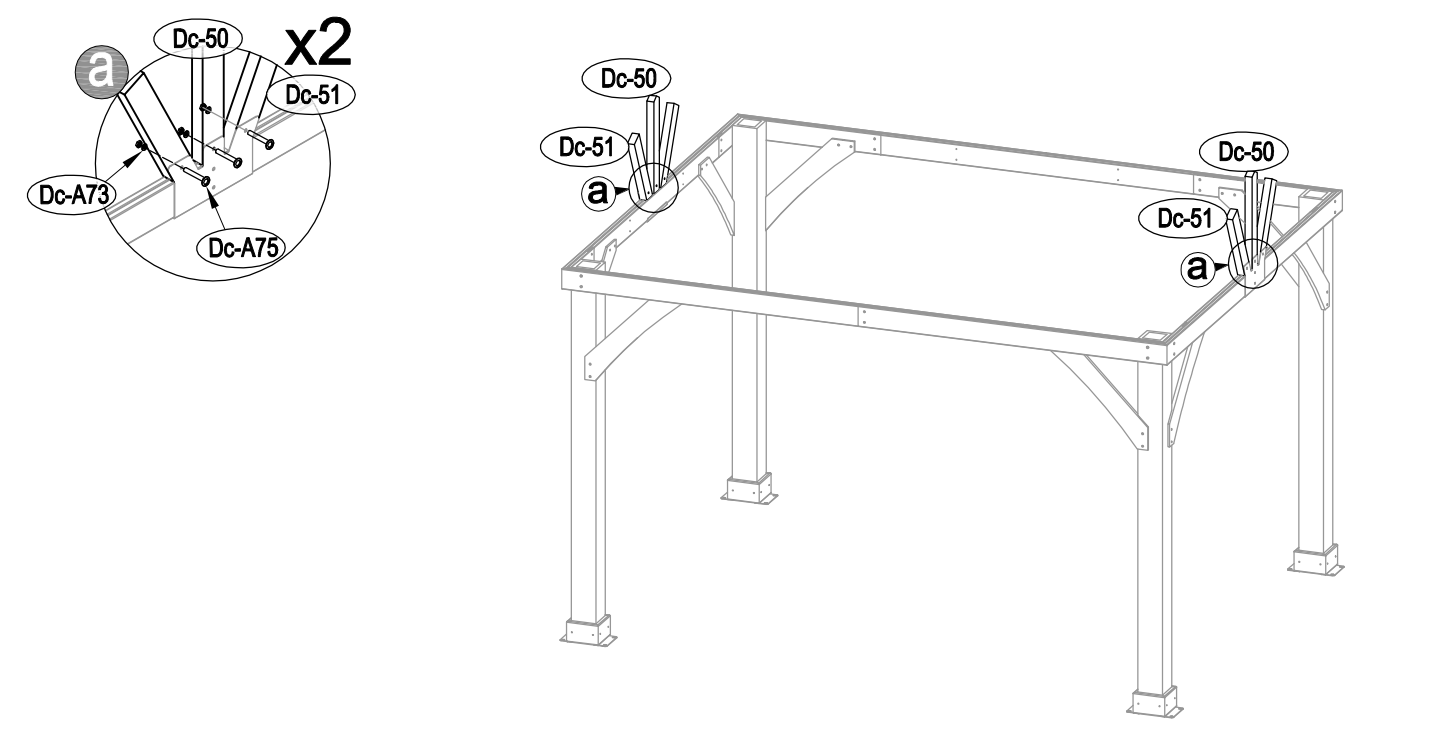

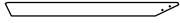
8	 Dc-50 [x2]	 Dc-51 [x4]	 Dc-A75 [x6] M8X50	 Dc-A73 [x6] M8	
----------	---	---	--	--	--



<p>9</p>	 <p>Dc-49 [x4]</p>	 <p>Dc-13 [x2]</p>	 <p>Dc-13a [x2]</p>	 <p>Dc-A75 [x8] M8X50</p>	 <p>Dc-A73 [x8] M8</p>	
-----------------	---	---	--	---	---	--

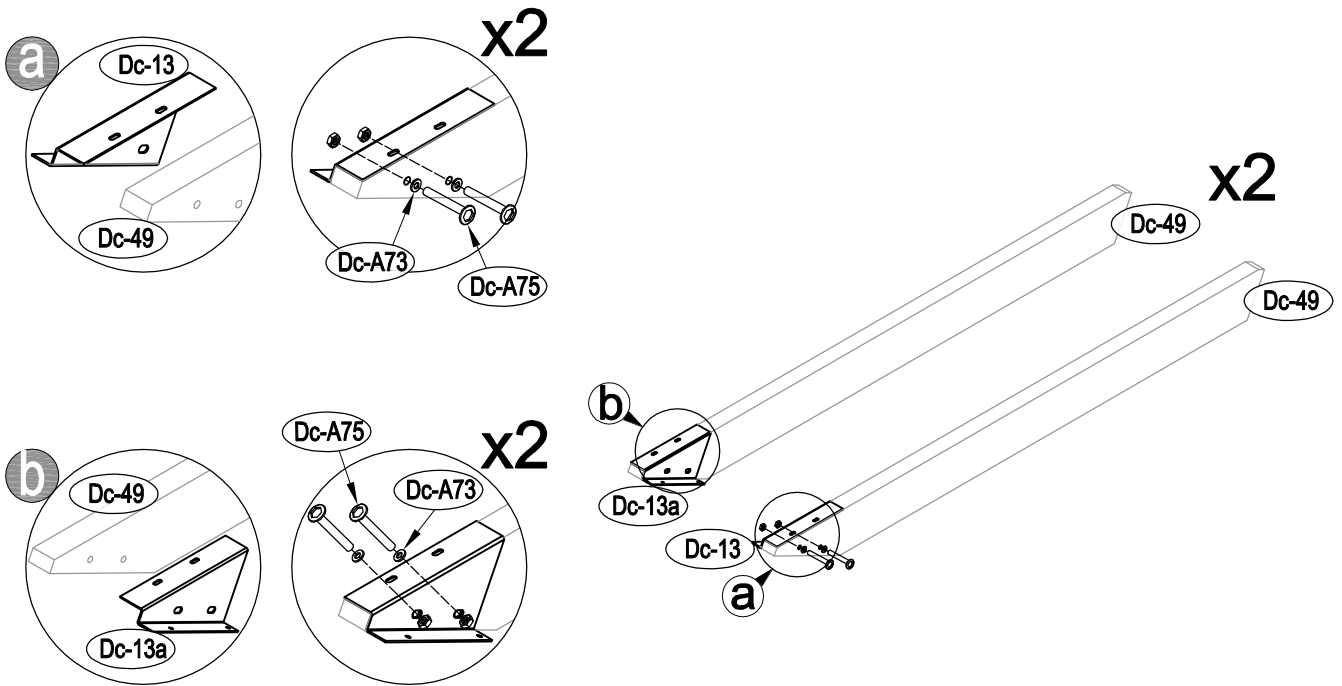

<p>10</p>	 <p>Dc-A64 [x8] M5X35</p>	
------------------	--	--

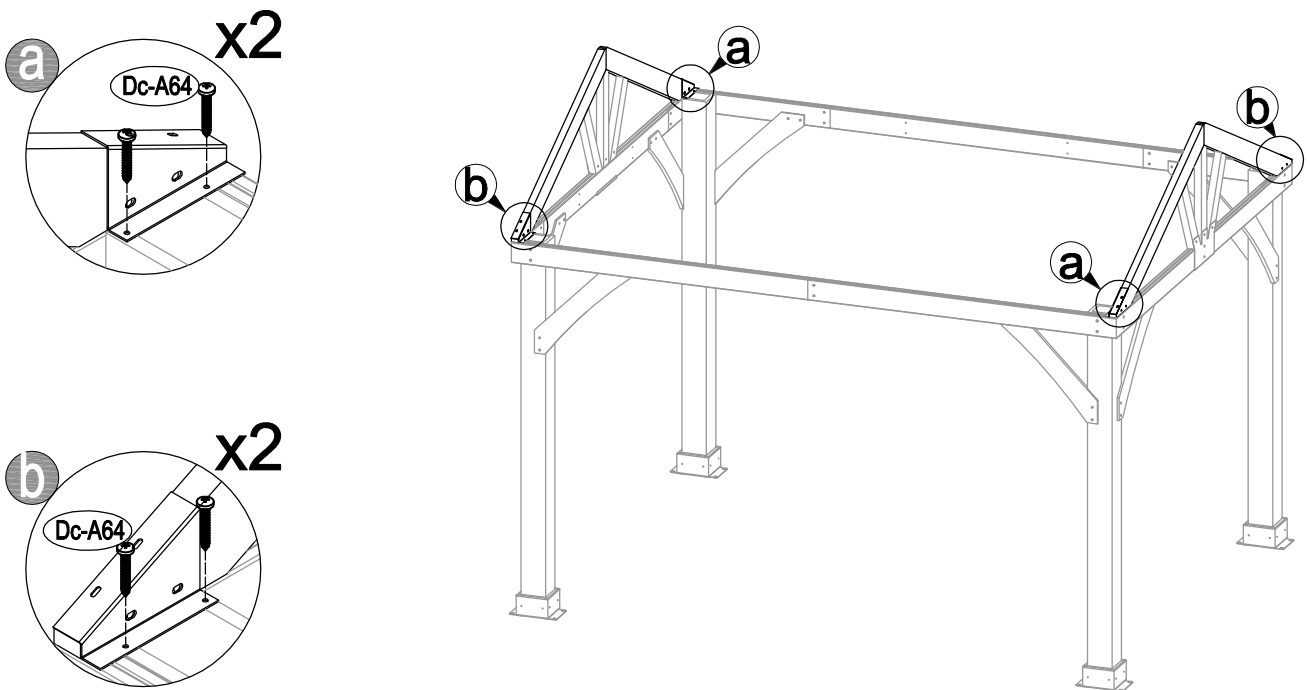

<p>11</p>	 <p>Dc-14 [x6]</p>	 <p>Dc-A65 [x30] ST4X16</p>			
------------------	---	--	--	--	--

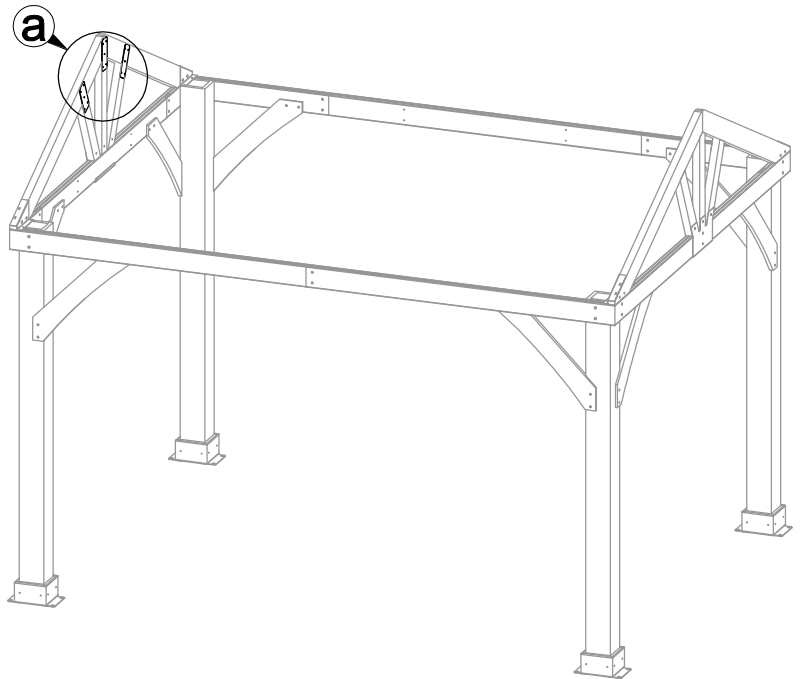
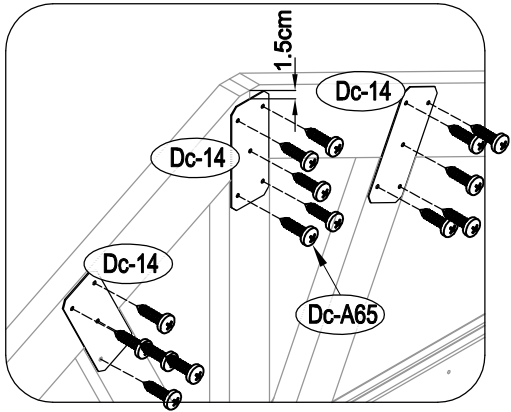

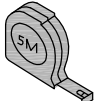
<p>12</p>		
------------------	---	--

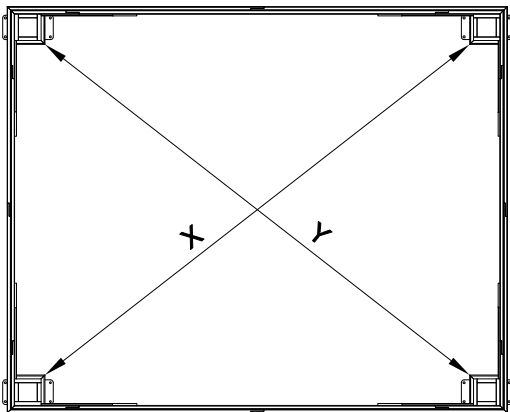



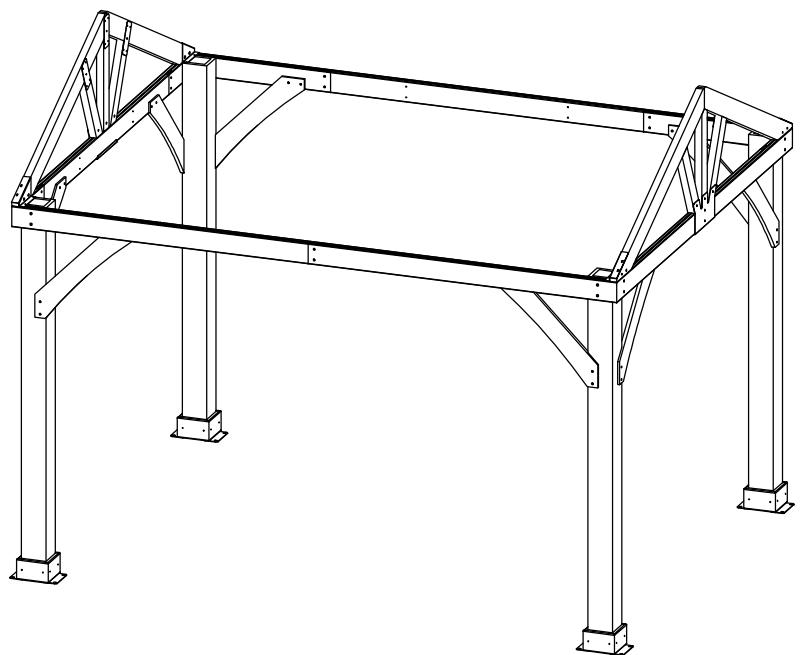

⚠ X=Y ±2cm

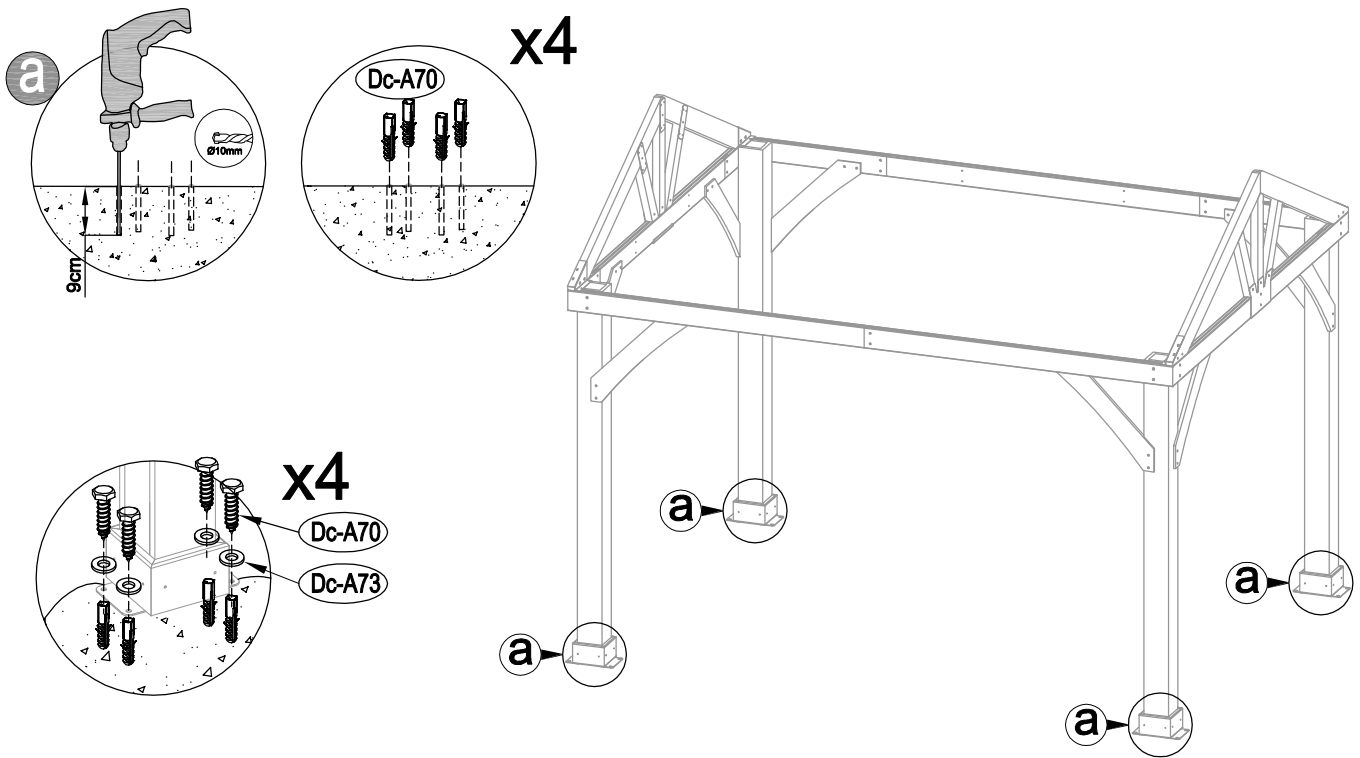





13		 Dc-A70 [x16] M8X60	 Dc-A73 [x16] M8	
----	---	---	--	--

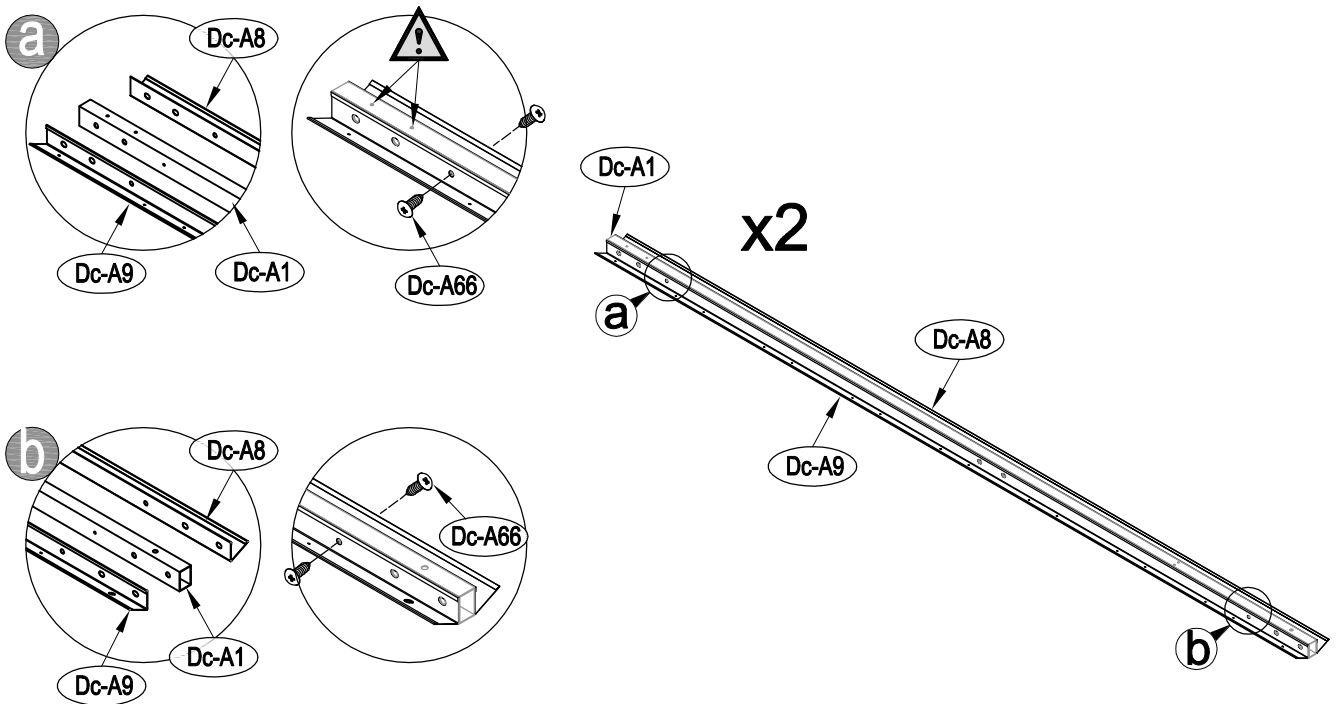

14	 Dc-A1 [x2]	 Dc-A8 [x2]	 Dc-A9 [x2]	 Dc-A66 [x8] ST4X10
----	---	---	---	--



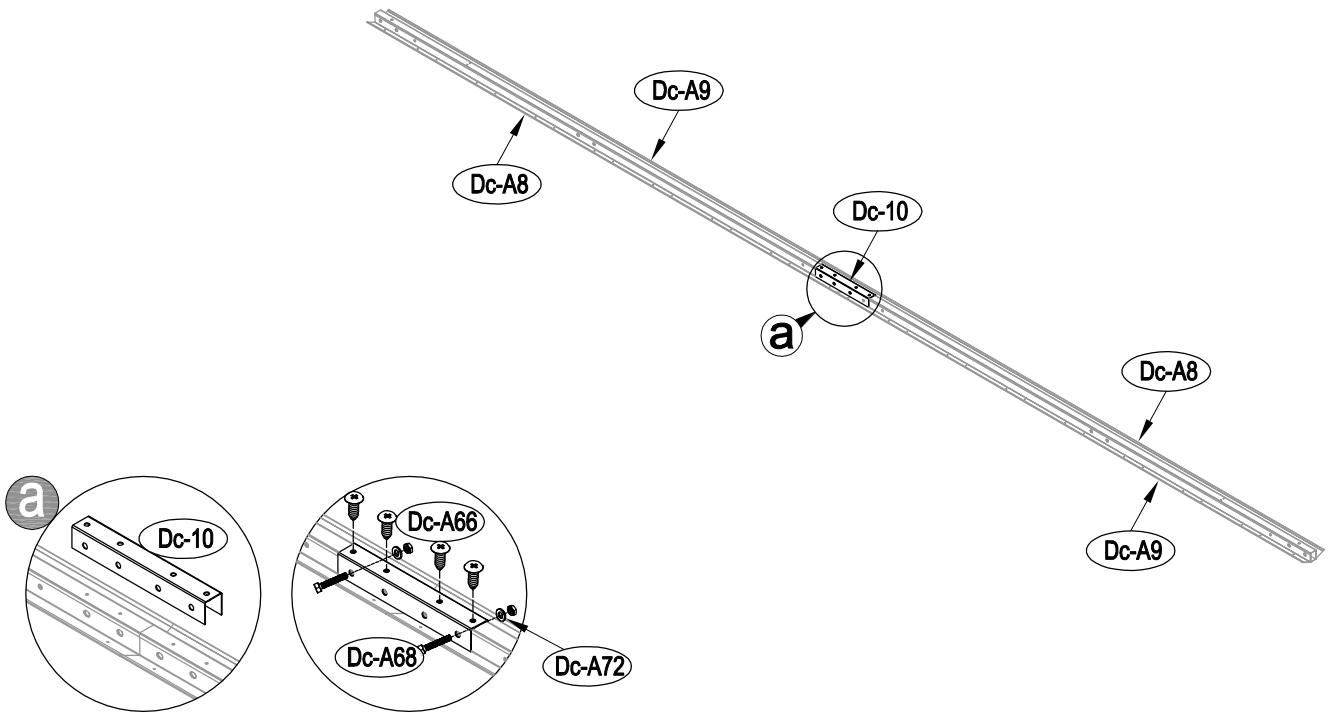

<p>15</p>	 <p>Dc-10 [x1]</p>	 <p>Dc-A66 [x4] ST4X10</p>	 <p>Dc-A68 [x2] M6X35</p>	 <p>Dc-A72 [x2] M6</p>	
------------------	---	---	--	--	--



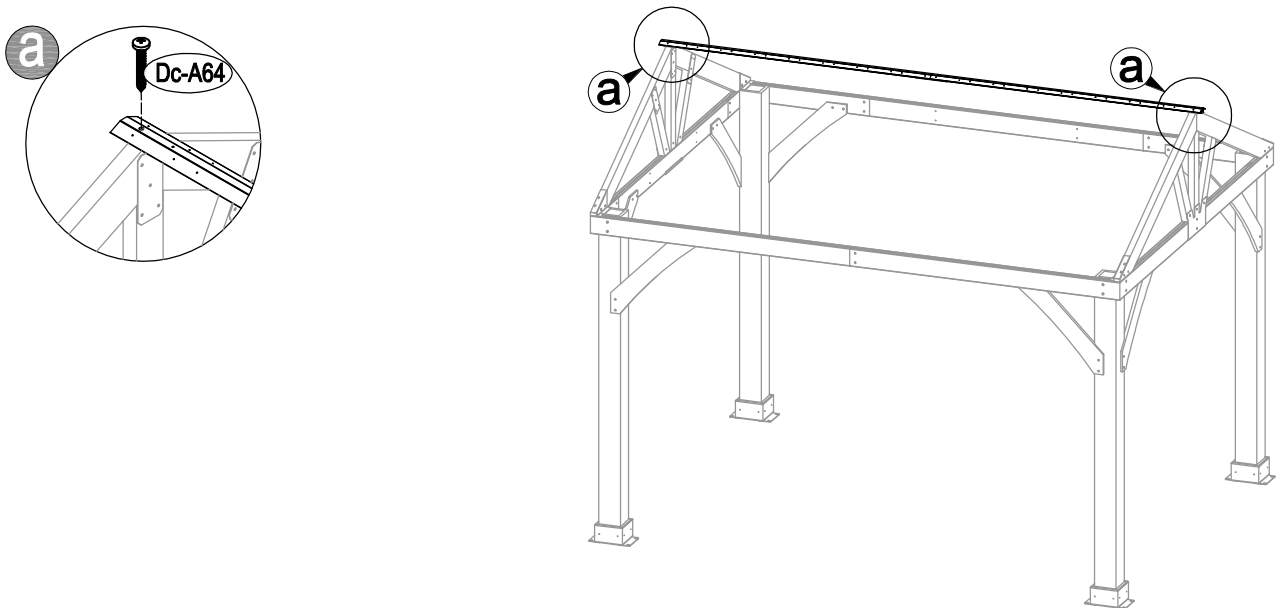



<p>16</p>	 <p>Dc-A64 [x2] M5X35</p>	
------------------	--	--

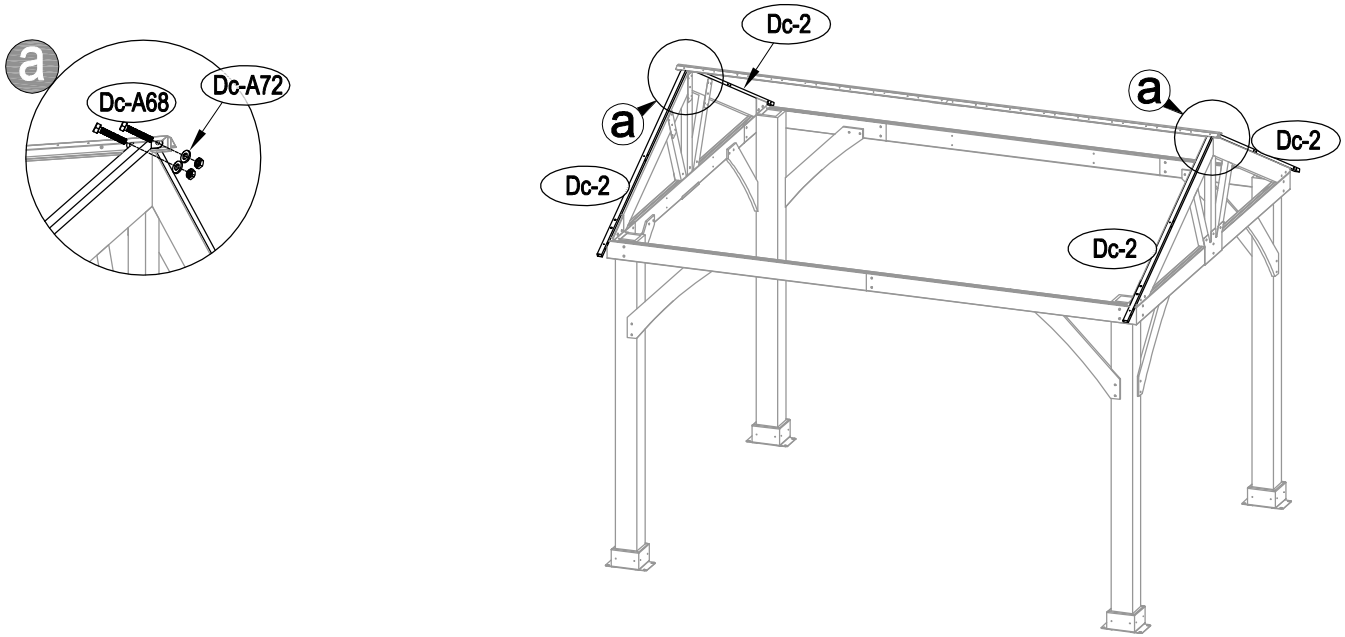

<p>17</p>	 <p>Dc-2 [x4]</p>	 <p>Dc-A68 [x4] M6X35</p>	 <p>Dc-A72 [x4] M6</p>	
------------------	--	--	---	--



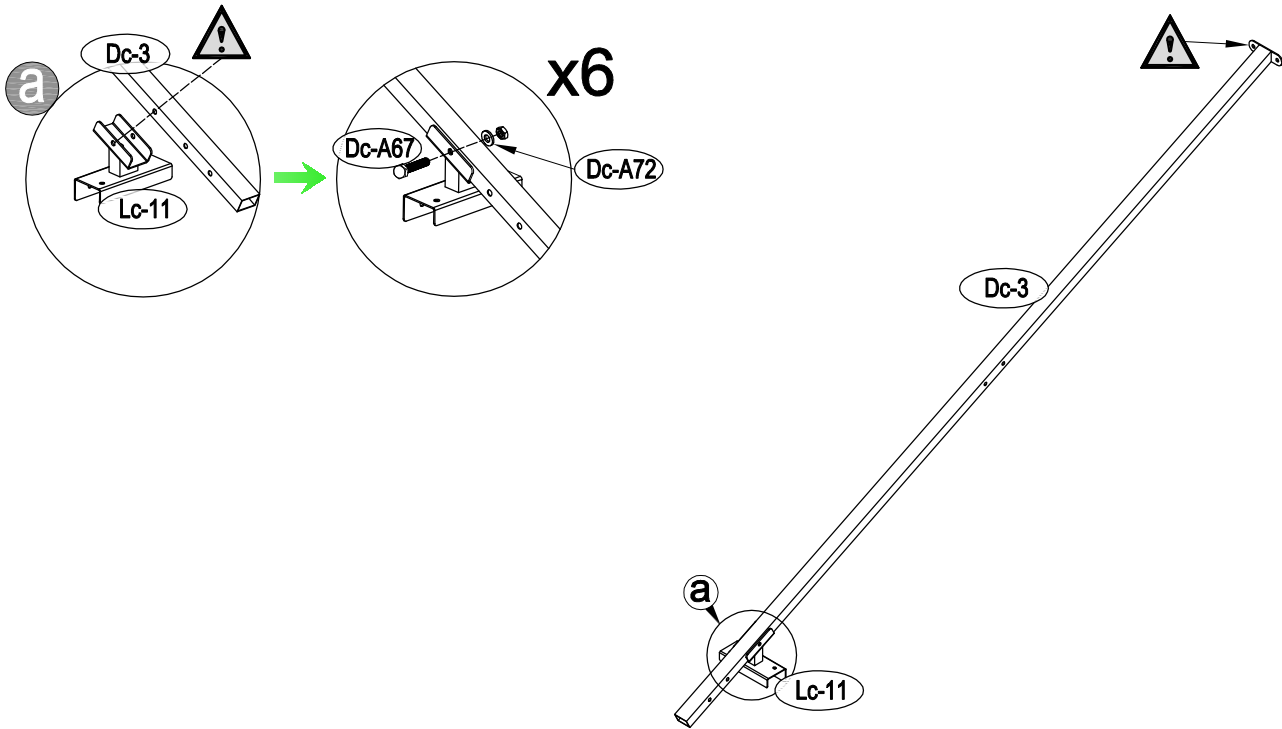

<p>18</p>	 <p>Dc-3 [x6]</p>	 <p>Lc-11 [x6]</p>	 <p>Dc-A67 [x6] M6X45</p>	 <p>Dc-A72 [x6] M6</p>	
------------------	--	---	--	---	--

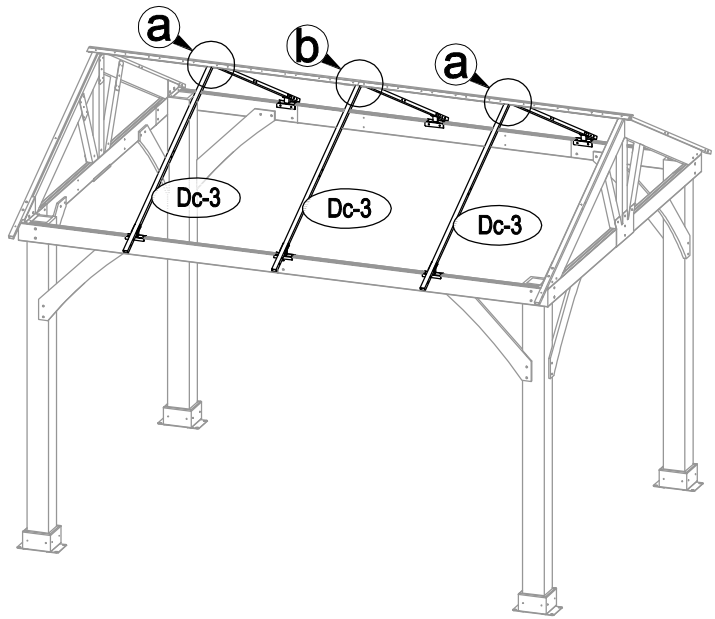
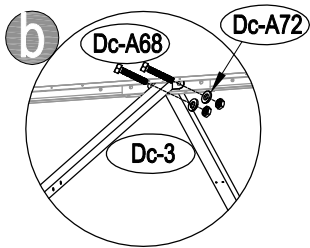
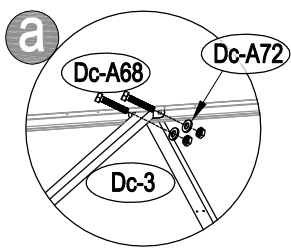

19	 Dc-A68 [x6] M6X35	 Dc-A72 [x6] M6	
----	--	---	--

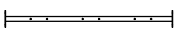
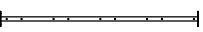

20	 Dc-A4 [x8]	 Dc-5 [x8]	 Dc-A67 [x40] M6X45	 Dc-A72 [x40] M6	
----	---	--	---	--	--

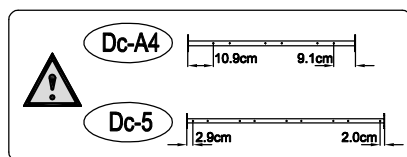
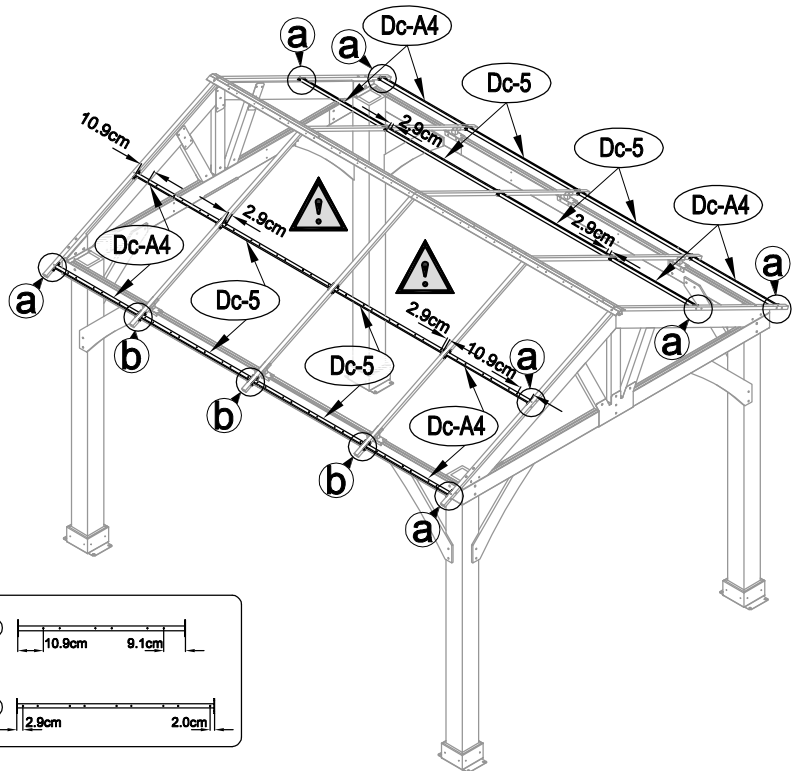
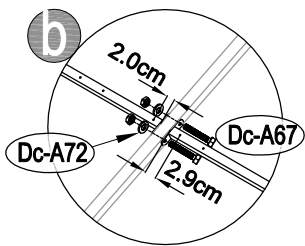
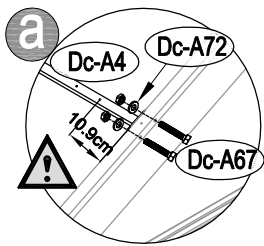

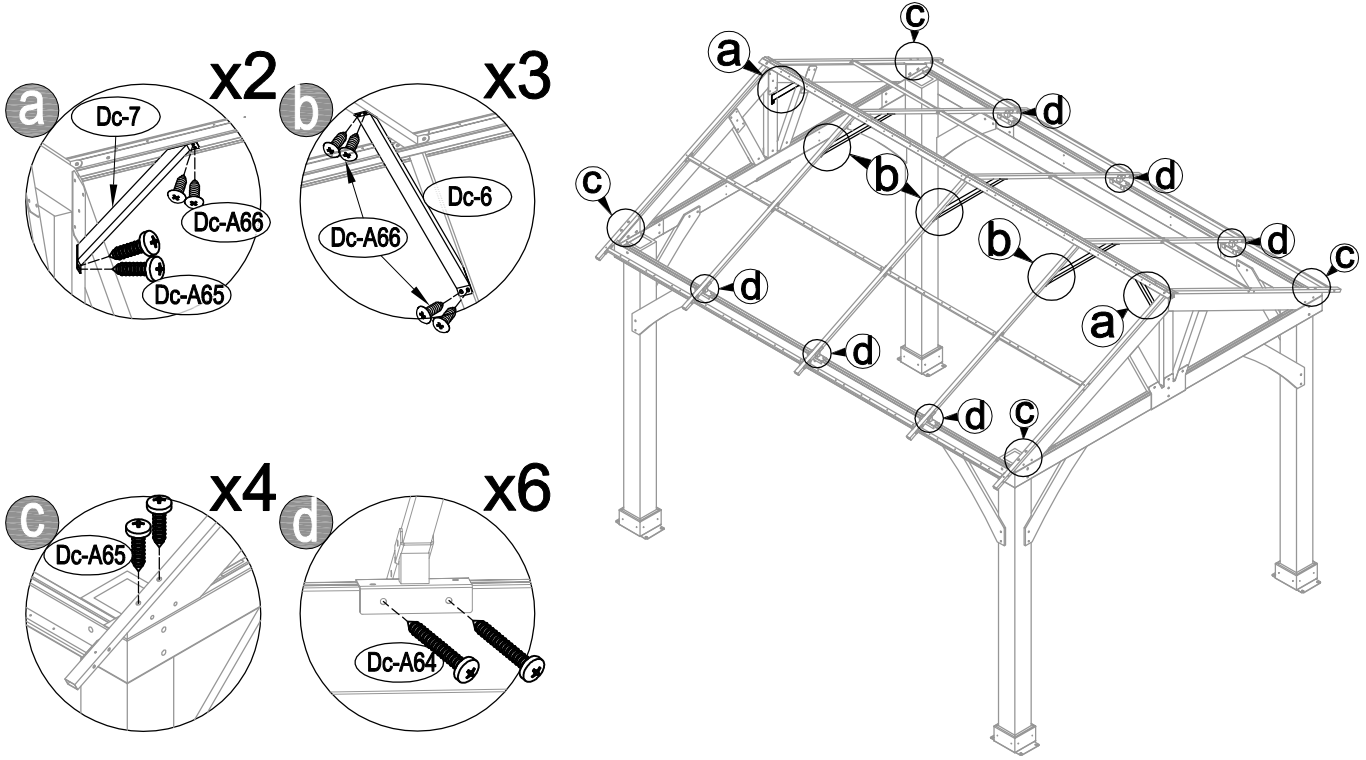

21	<p>Dc-6 [x3]</p>	<p>Dc-7 [x2]</p>	<p>Dc-A64 [x12] M5X35</p>	<p>Dc-A65 [x12] ST4X16</p>	<p>Dc-A66 [x16] ST4X10</p>	
----	------------------	------------------	---------------------------	----------------------------	----------------------------	--



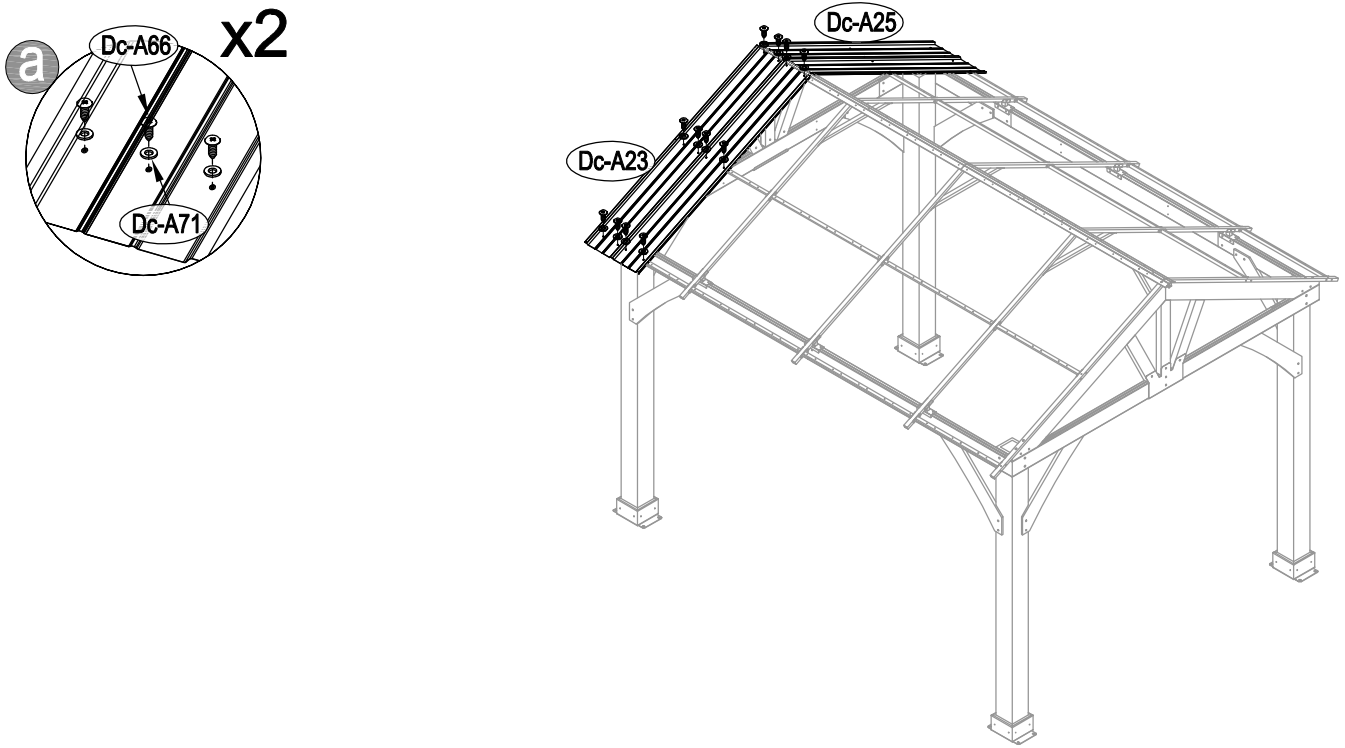

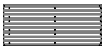

22	<p>Dc-A23 [x1]</p>	<p>Dc-A25 [x1]</p>	<p>Dc-A66 [x24] ST4X10</p>	<p>Dc-A71 [x24]</p>	
----	--------------------	--------------------	----------------------------	---------------------	--

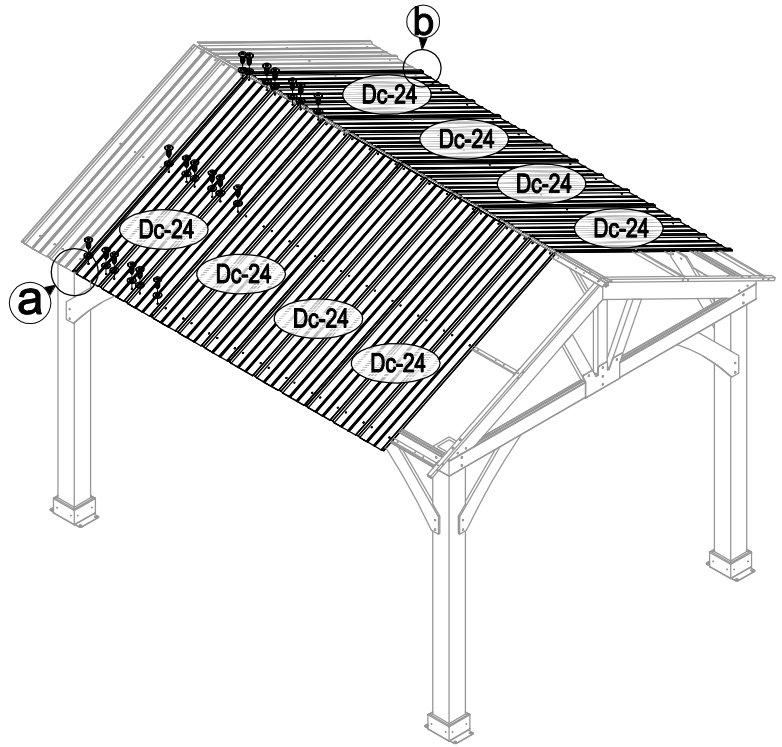
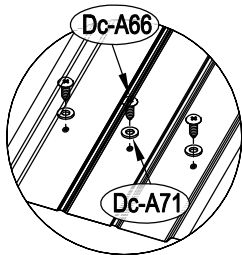
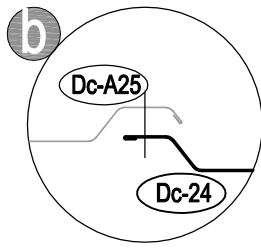
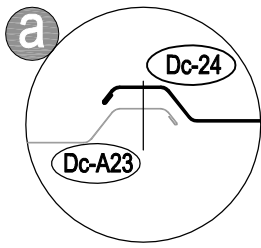

23	 Dc-24 [x8]	 Dc-A66 [x152] ST4X10	 Dc-A71 [x152]	
----	---	---	--	--



24	 Dc-A23 [x1]	 Dc-A25 [x1]	 Dc-A66 [x26] ST4X10	 Dc-A71 [x26]	
----	--	--	--	---	--

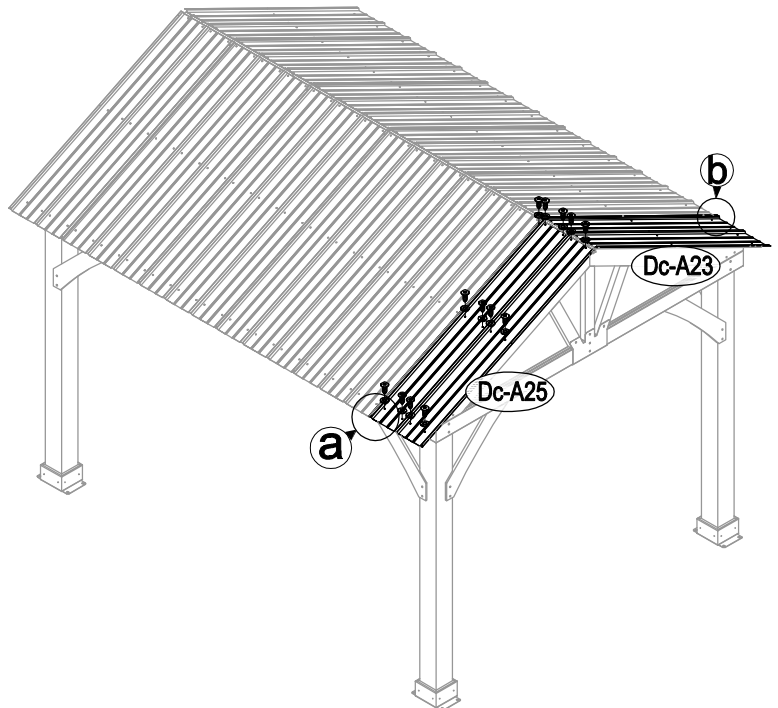
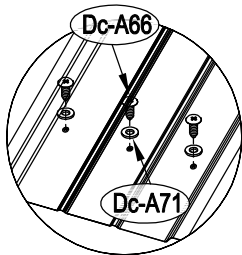
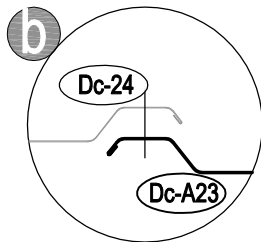
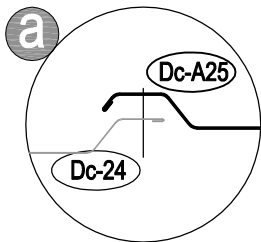

25	Ab-26 [x2]	Lc-26 [x2] Lc-26a [x2]	Dc-27 [x2] Dc-27a [x2]	BCP3 [x4]	Dc-A66 [x22] ST4X10	Dc-A71 [x18]
----	------------	---------------------------	---------------------------	-----------	---------------------	--------------

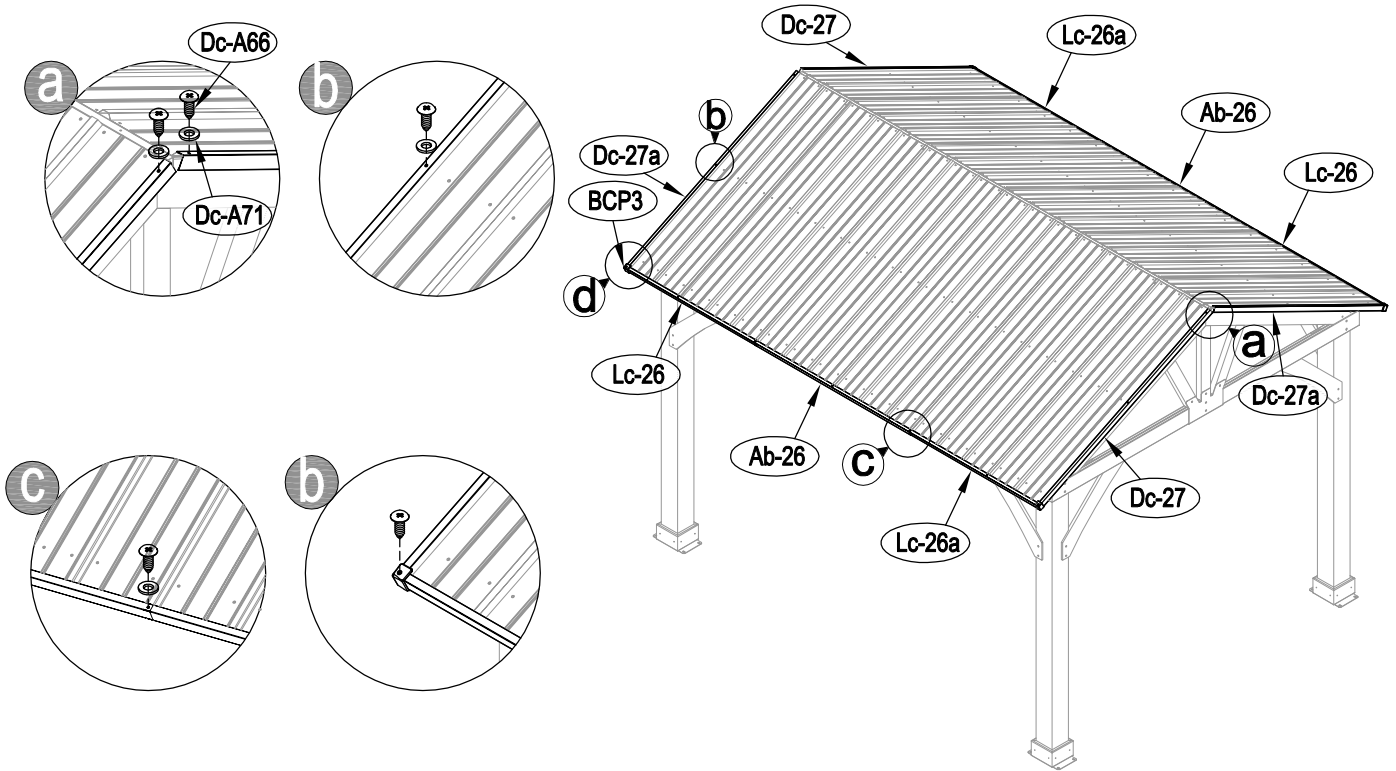

26	Dc-A28 [x2]	Dc-A69 [x4] ST4.8X35	
----	-------------	----------------------	--

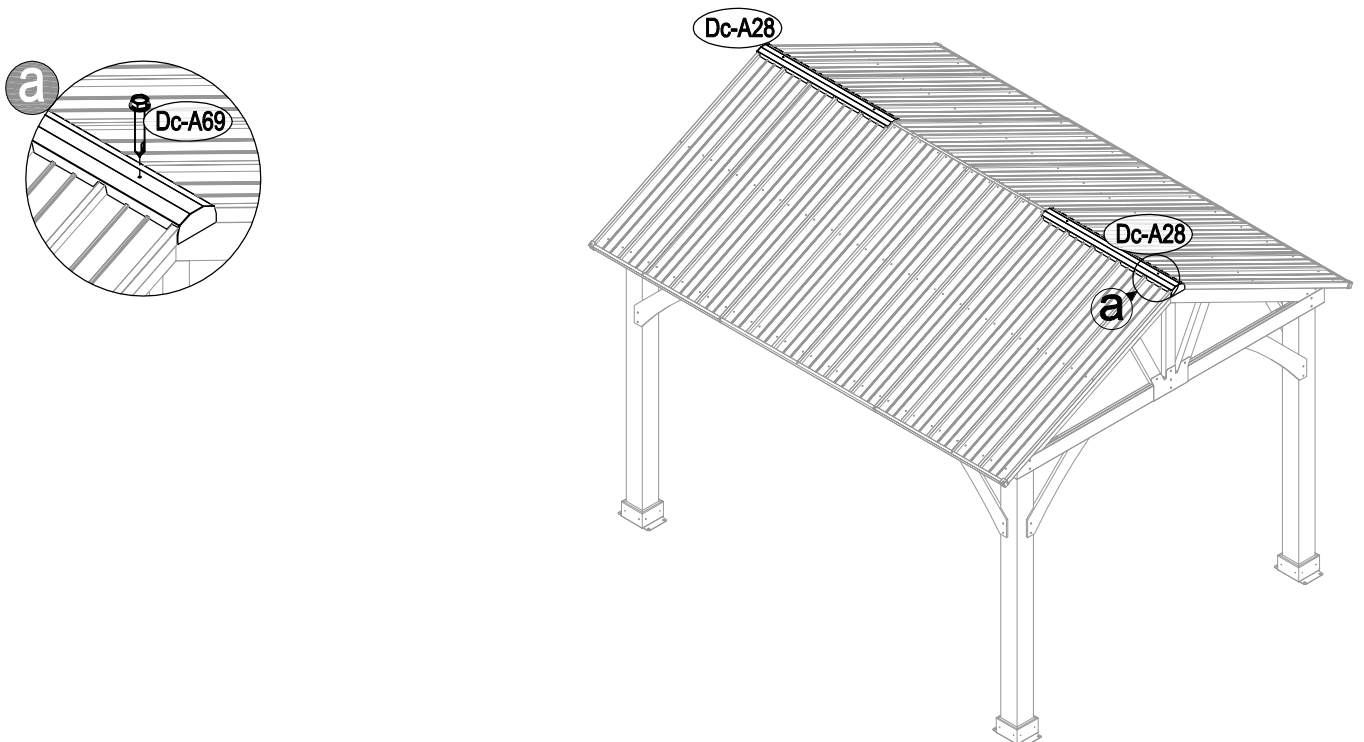

<p>27</p>	 <p>Dc-28 [x1]</p>	 <p>Dc-A69 [x2] ST4.8X35</p>	
------------------	---	---	--

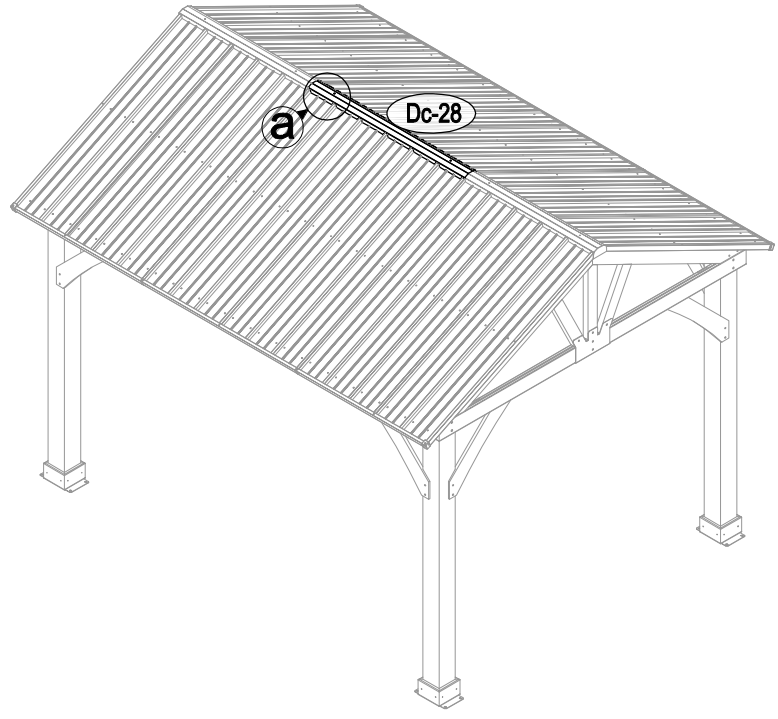
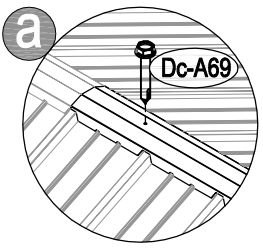

<p>28</p>	 <p>Dc-A58 [x116] M6</p>	 <p>Dc-A59 [x16] M8</p>	
------------------	---	--	--

