

HARDMAISTER

Zabudowa do segregacji Garbage bin storage

Instrukcja montażu DAVIS 6x3
Assembly instructions DAVIS 6x3

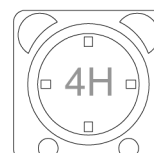
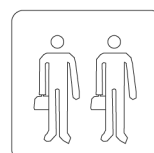
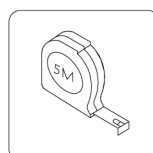
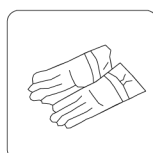
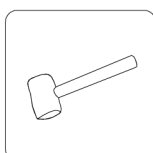
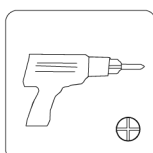
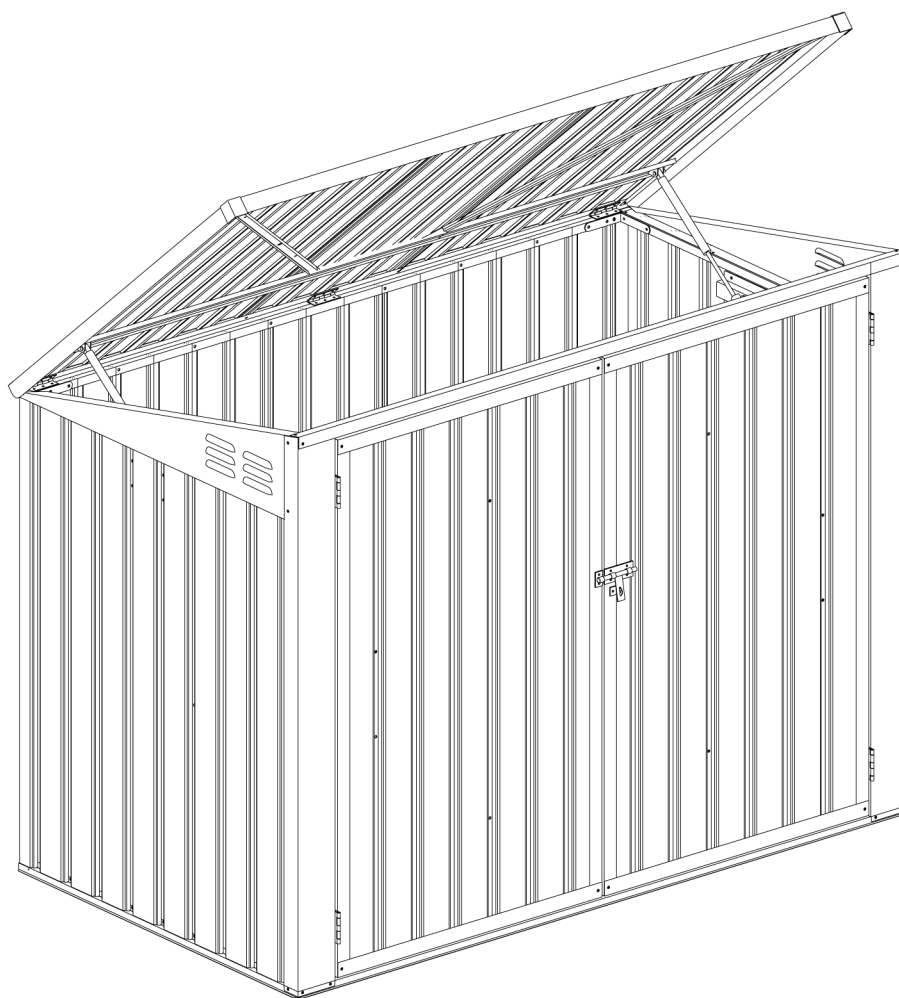

Przygotowanie do montażu

Instrukcja obsługi

Przed rozpoczęciem montażu należy sprawdzić lokalne przepisy budowlane dotyczące fundamentu, lokalizacji i innych wymagań.

Instrukcja montażu:

Przed rozpoczęciem prac przejrzyj wszystkie instrukcje i stosowne informacje. Upewnij się, że postępujesz krok po kroku, aby uzyskać pomyślne rezultaty.

Podstawa podłogi:

Przed rozpoczęciem montażu należy wybrać odpowiednie miejsce na zabudowę, najlepszą lokalizacją jest czworokątny, równy, wypoziomowany teren z dobrym odpływem wody. Podstawy nie ma w zestawie, może wymagać zakupu osobno lub zbudowania własnego fundamentu i systemu kotwienia. Podstawa fundamentu powinna być o 10cm większa niż wymiary podstawy zabudowy (zalecana jest płyta betonowa o grubości minimum 10cm). Pod fundamentem należy umieścić wytrzymałą warstwę z tworzywa sztucznego (grubość: co najmniej 150 µm), aby ograniczyć przenikanie wilgoci z gleby, zmniejszając tym samym gromadzenie się nawilgocenia wewnątrz. Zabudowa musi być solidnie zakotwiczona, aby zapobiec uszkodzeniom powodowanym przez wiatr.

Lista części:

Zanim zaczniesz, upewnij się, że posiadasz wszystkie niezbędne części do montażu (patrz strona z listą części). Nie próbuj montować jeśli brakuje części, ponieważ każda zabudowa pozostawiony częściowo zmontowany może zostać poważnie uszkodzony przez lekki wiatr.

Przed montażem należy oderwać warstwę ochronną, w razie potrzeby zachować etykietę z numerem części.

Potrzebne narzędzia:

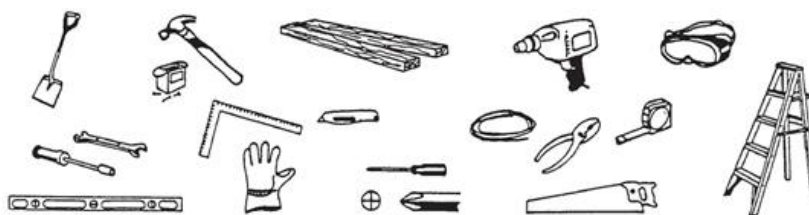

Bezpieczeństwo przede wszystkim:

1. Montaż zabudowy powinien się odbywać w suchy i spokojny dzień, nie należy podejmować pracy podczas niekorzystnych warunków pogodowych. Przy montażu zabudowy powinny brać udział co najmniej dwie osoby. Zaleca się zakończyć montaż w jeden dzień, aby uniknąć uszkodzenia produktu lub zagubienia niektórych małych części. Wszystkie drobne części (śruby itp.) przechowuj w naczyniu, aby się nie pogubiły.

2. Aby zapobiec obrażeniom, podczas montażu konieczne jest noszenie rękawic ochronnych, okularów ochronnych i odzieży roboczej z długim rękawem. Należy zwrócić szczególną uwagę na ostre krawędzie niektórych elementów domku i zachować szczególną ostrożność podczas manewrowania nimi i montażu.
3. Zabrania się wstępu na teren budowy dzieci, osób niepełnoletnich, osób niepełnosprawnych, osób nietrzeźwych lub pod wpływem środków odurzających oraz zwierząt.
4. Nigdy nie wolno obciążać dachu budynku całkowitą masą ciała. Korzystając z drabiny schodkowej, należy upewnić się, że jest bezpieczna i ustawiona na płaskim podłożu.

Pielęgnacja i konserwacja:

1. Utrzymuj zabudowę w czystości używając miękkiej ściereczki, w razie potrzeby z dodatkiem wody.

Assembly Preparation

Owner's Manual

Please check local building codes regarding footings, location and other requirements before beginning construction.

Assembly instructions:

Reviewing all instructions and the appropriate information before you begin, make sure following the step sequence carefully for successful results.

Flooring base:

A good location for the storage is a square and level area with good drainage. The base is not included in the kit which may need purchase separately or may construct a foundation and anchoring system of your own. The foundation base should be 10 cm larger than the base rail of the storage (minimum 10cm thickness concrete slab is recommended).

A strong plastic sheet (thickness: at least 150µm) should be placed under the foundation to assist in reducing rising dampness from the soil, thus reducing condensation build up in the storage. Your storage building must be anchored to prevent wind damage.

Parts and Parts List:

Before you start, check to be sure that you have all the necessary parts for your building (refer to the Parts List Page). Do not attempt to assemble the building if parts are missing because any building left partially assembled may be seriously damaged by light winds.

Please tear off the safety protection layer before assembly, keep the part number label if needed.

Tools you need:

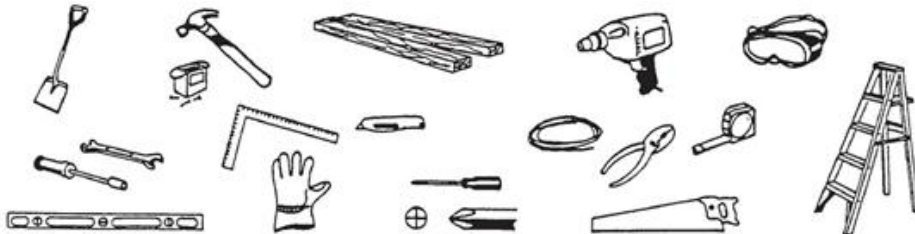

Safety must be put in the No. 1 position:

1. Select a dry and calm day for your assembly. Team works (Two or more people) are required during the assembly. It is also recommended to finish the assembly in a day to avoid damage to the product or missing of some small parts. Keep all small parts (screws etc.) in a bowl so they do not get lost.

Care & Maintenance:

1. Keep the shed clean with soft cloth, use water if necessary..

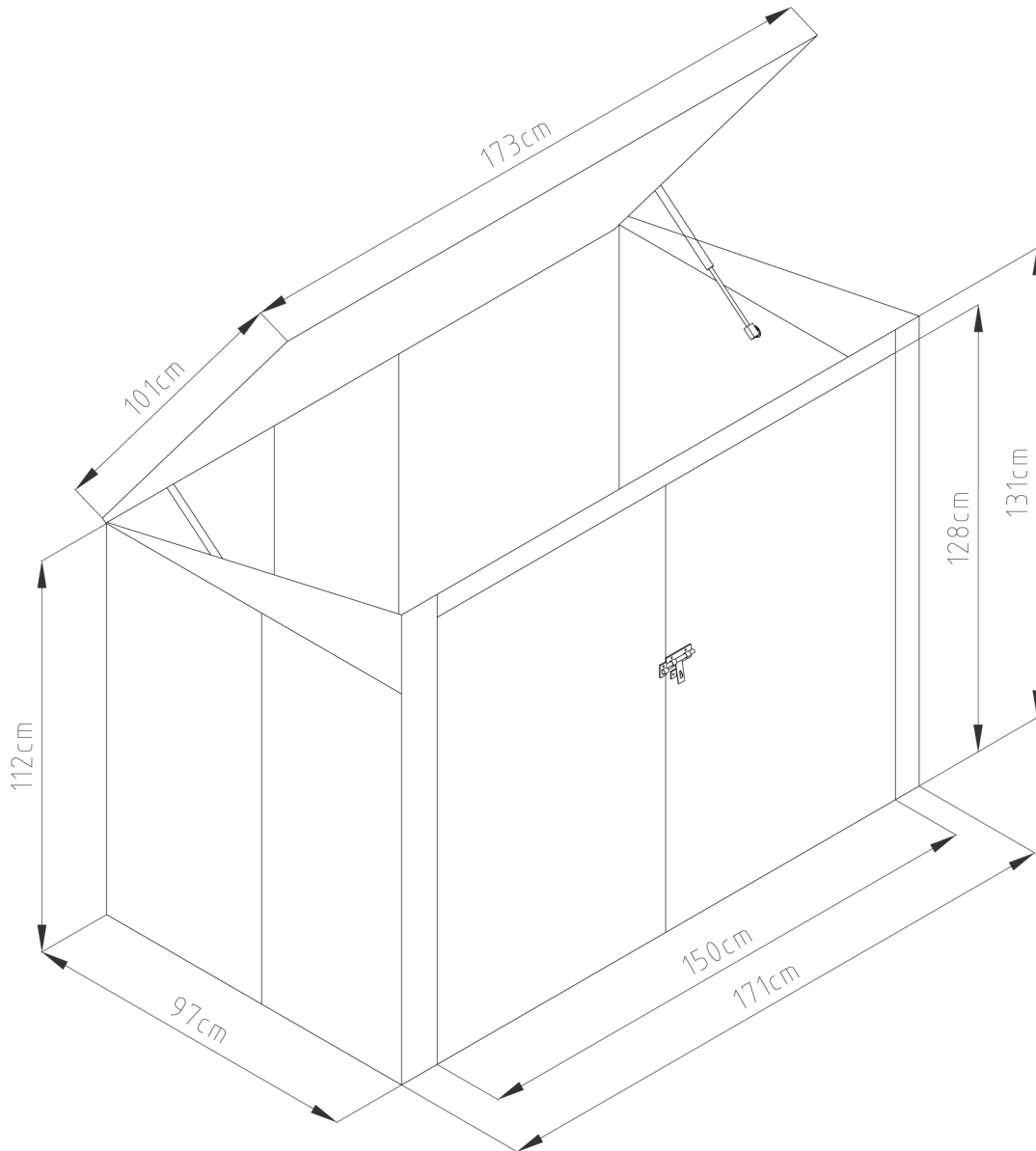



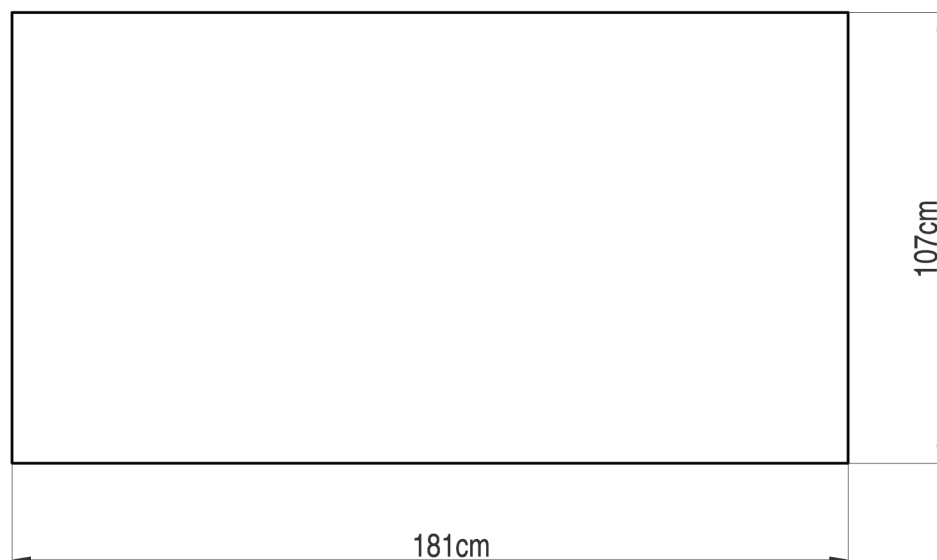

Wymagana powierzchnia podstawy:
Area of installation requirement:

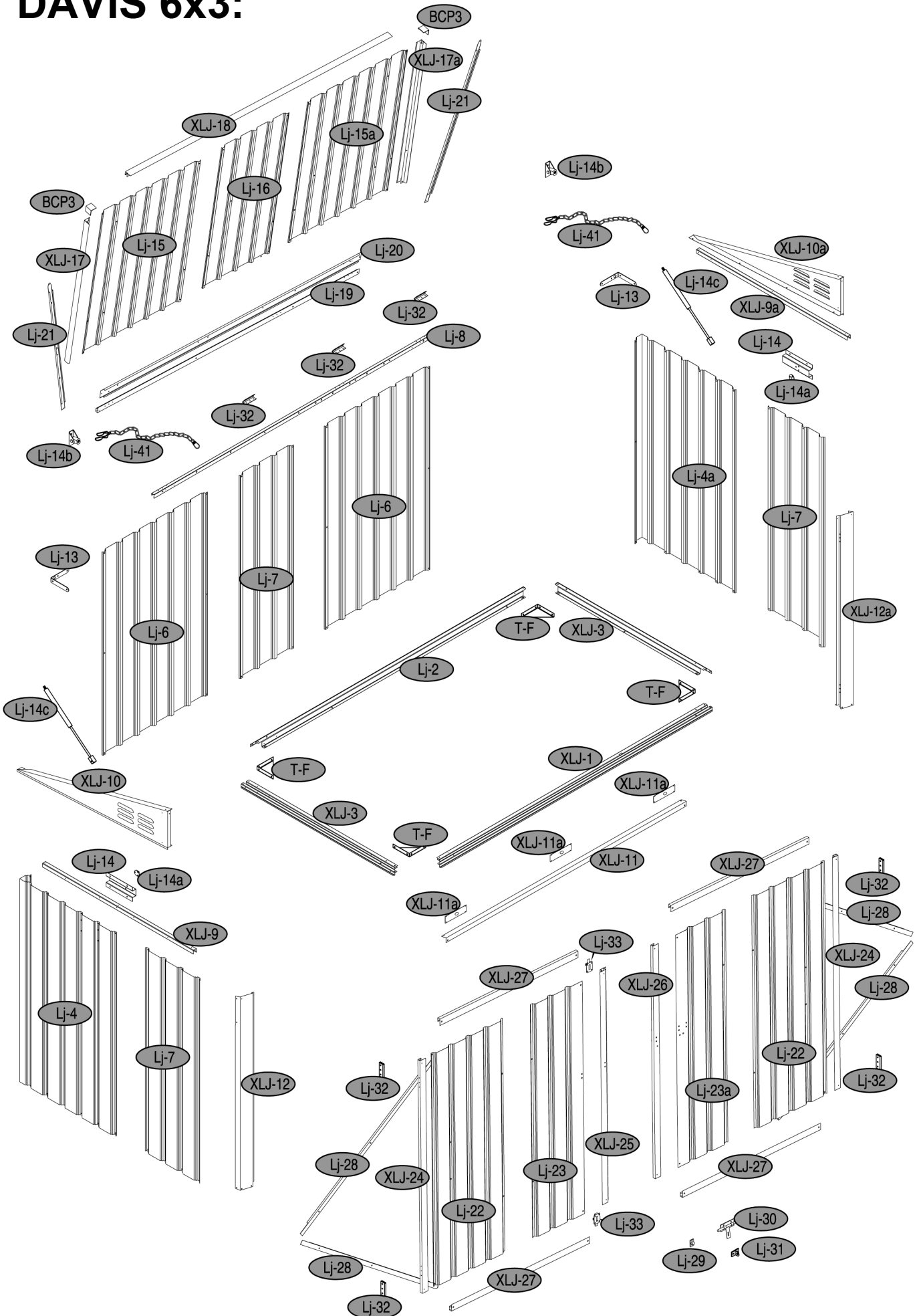

DAVIS 6x3:



| | | | | | |
|---|---|--|---|--|--|
| 1 |  XLJ-1 [x1] |  Lj-2 [x1] |  XLJ-3 [x2] |  Lj-35 [x8] | |
|---|---|--|---|--|--|

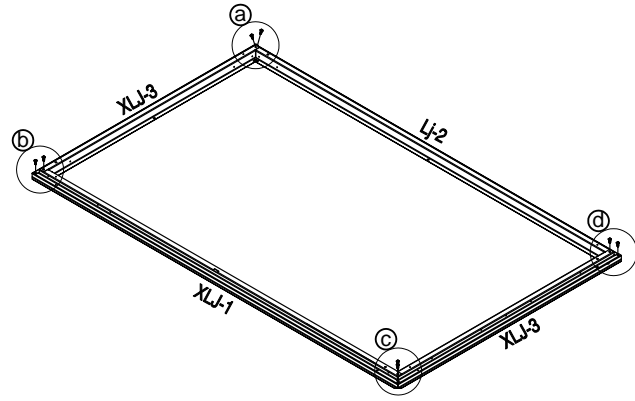
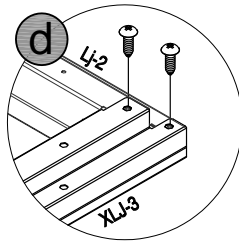
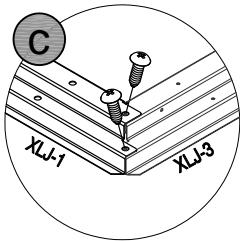
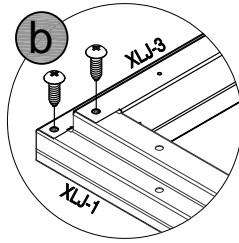
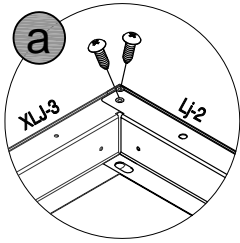



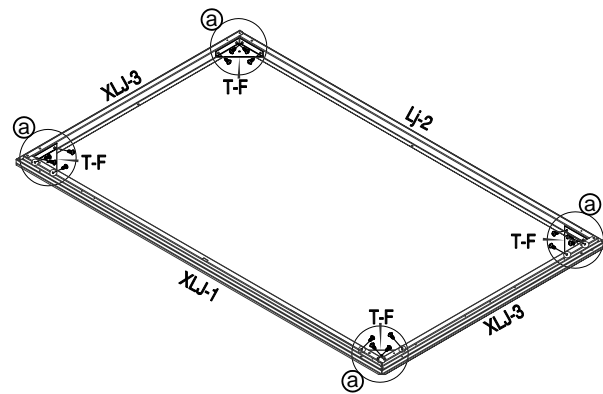
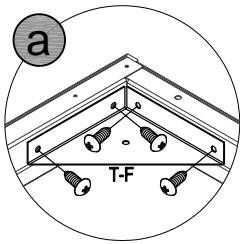

| | | | |
|---|---|--|--|
| 2 |  T-F [x4] |  Lj-35 [x16] | |
|---|---|--|--|

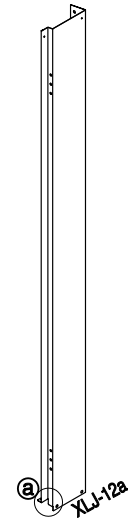
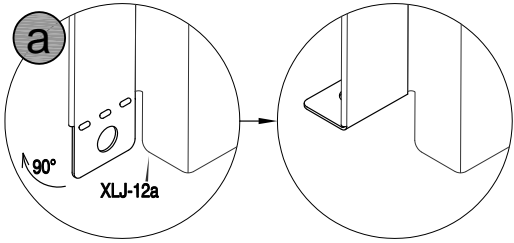

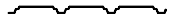

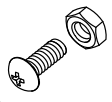

| | | | | |
|----------|---|--|--|--|
| 3 |  | | | |
| | XLJ-12a [x1] | | | |

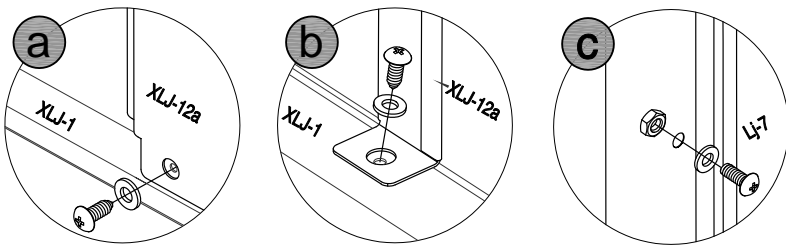
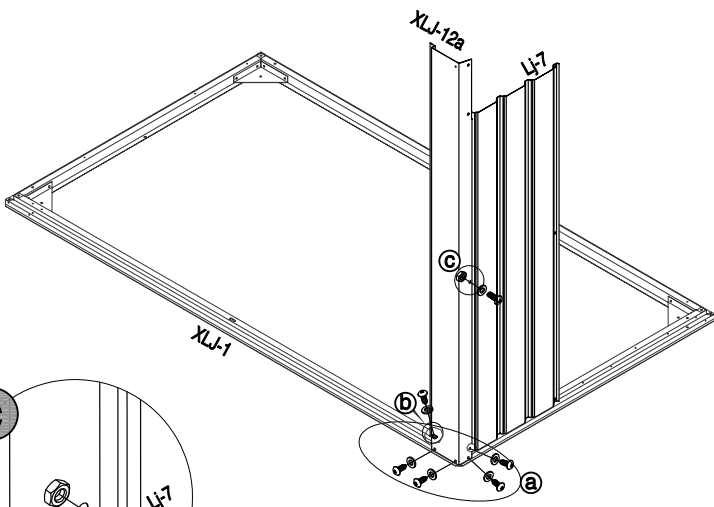
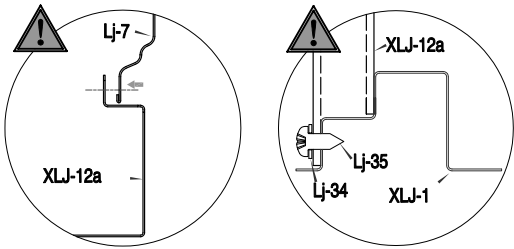

| | | | | | |
|----------|---|---|---|--|--|
| 4 |  |  |  |  | |
| | Lj-7 [x1] | Lj-35 [x5] | Lj-36 [x1] | Lj-34 [x6] | |





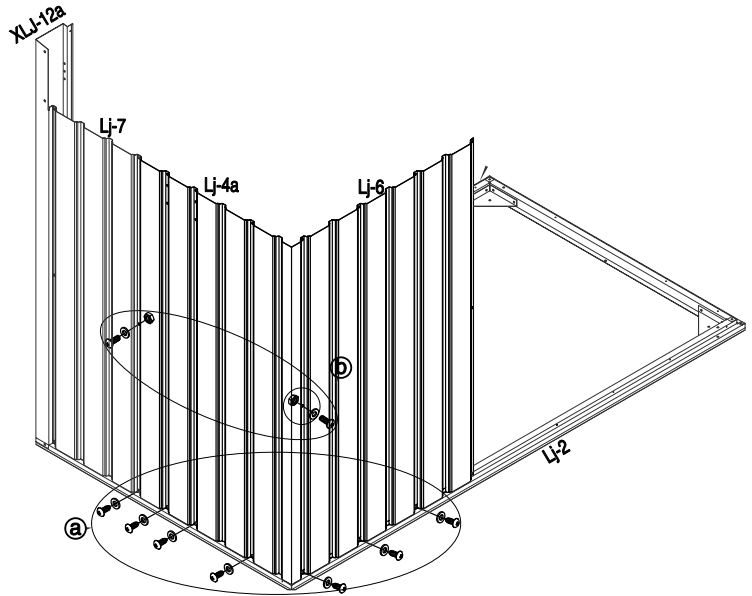
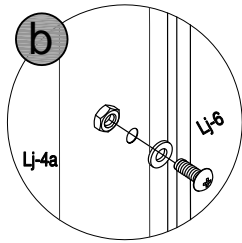
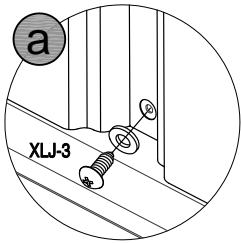
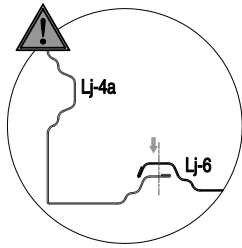
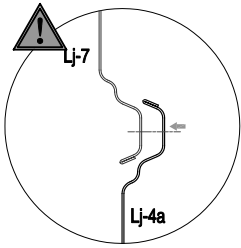

| | | | | | | |
|---|---|--|---|--|---|--|
| 5 |  Lj-4a [x1] |  Lj-6 [x1] |  Lj-35 [x7] |  Lj-36 [x2] |  Lj-34 [x9] | |
|---|---|--|---|--|---|--|

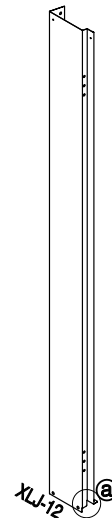
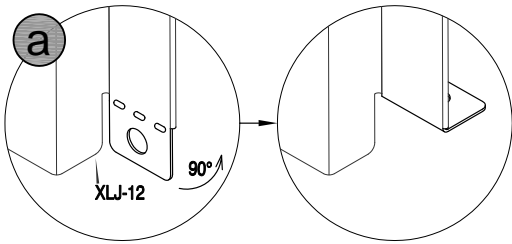





| | | |
|---|--|--|
| 6 |  XLJ-12 [x1] | |
|---|--|--|

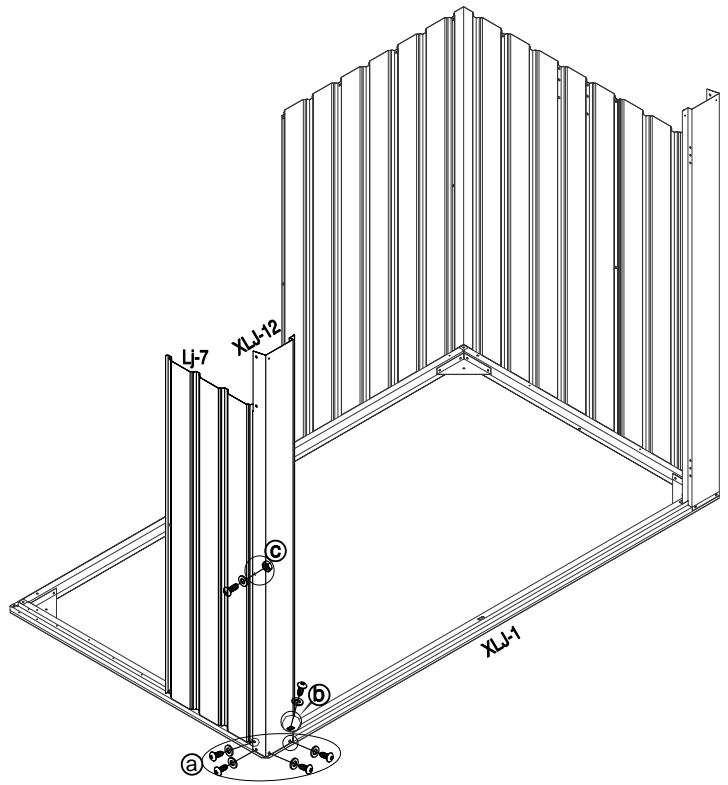
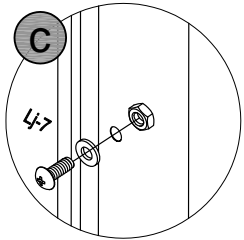
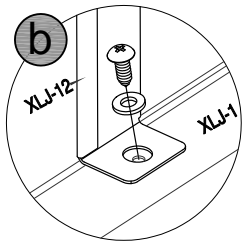
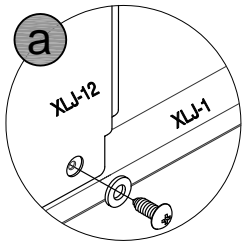
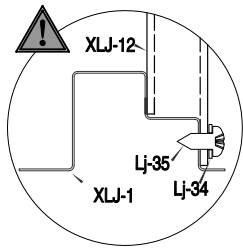
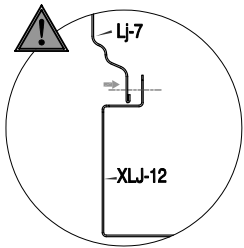





| | | | | | |
|---|--|---|---|--|--|
| 7 |  Lj-7 [x1] |  Lj-35 [x5] |  Lj-36 [x1] |  Lj-34 [x6] | |
|---|--|---|---|--|--|

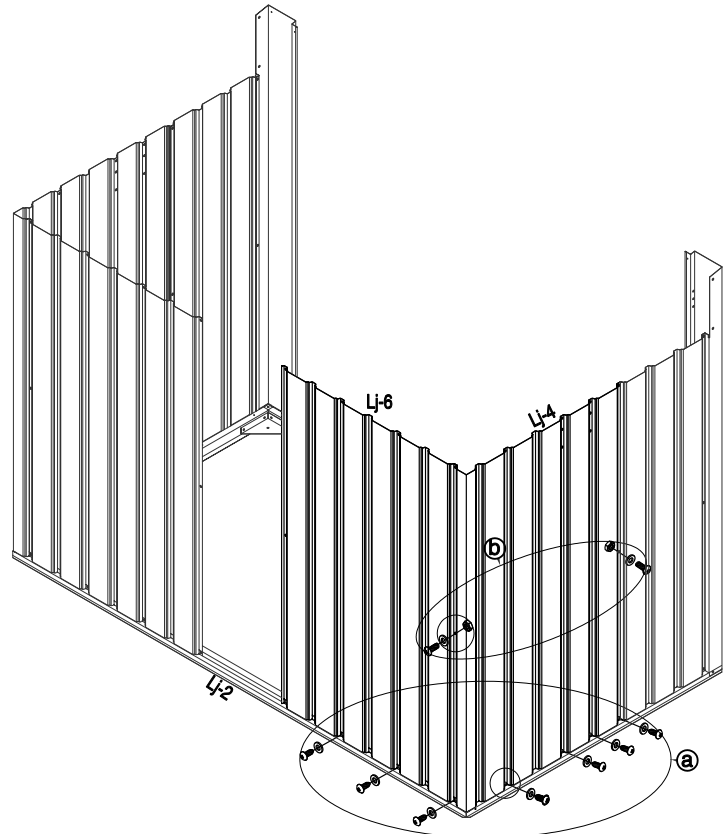
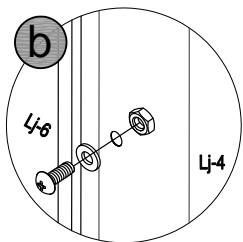
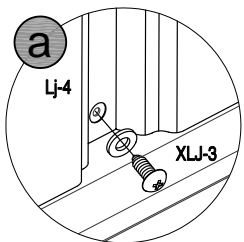
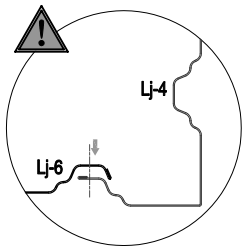
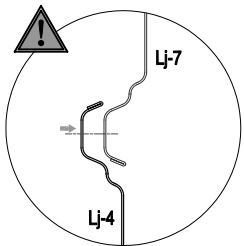

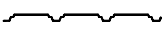
| | | | | | |
|---|--|--|---|--|---|
| 8 |  Lj-4 [x1] |  Lj-6 [x1] |  Lj-35 [x7] |  Lj-36 [x2] |  Lj-34 [x9] |
|---|--|--|---|--|---|





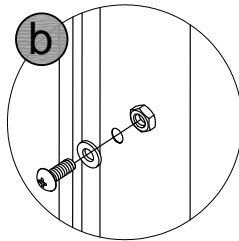
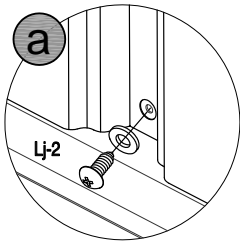
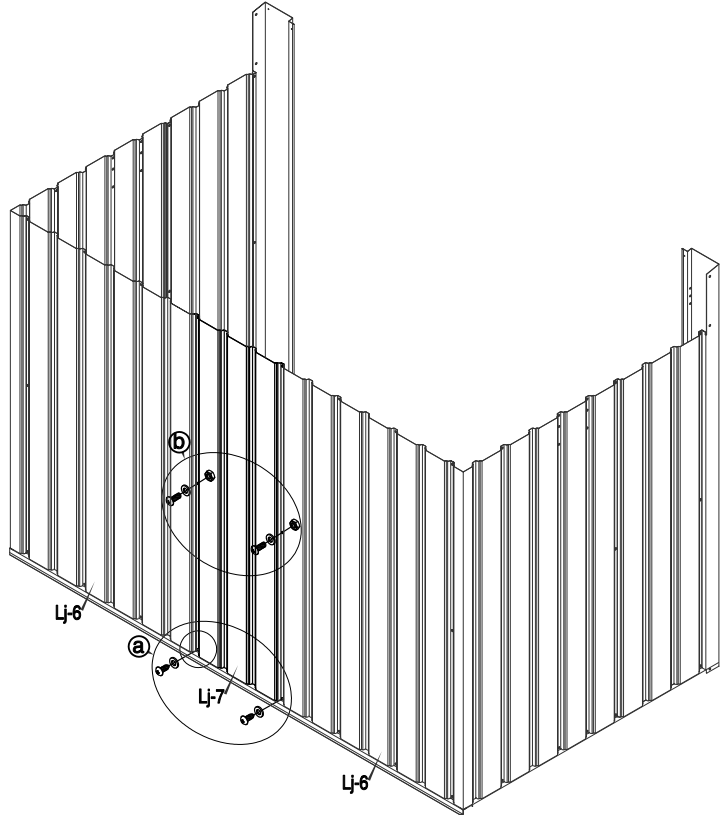
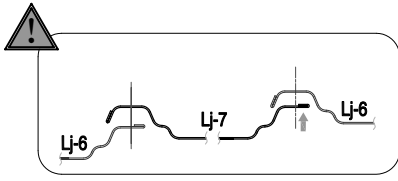

| | | | | | |
|---|--|---|---|--|--|
| 9 |  Lj-7 [x1] |  Lj-35 [x2] |  Lj-36 [x2] |  Lj-34 [x4] | |
|---|--|---|---|--|--|

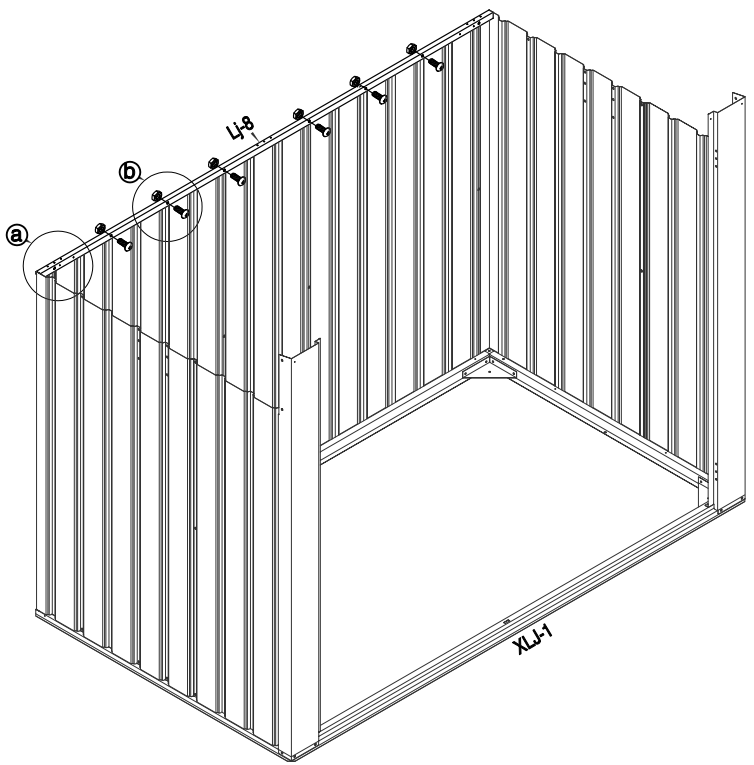
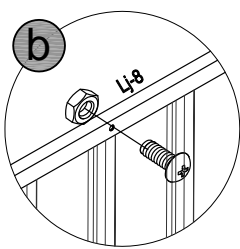
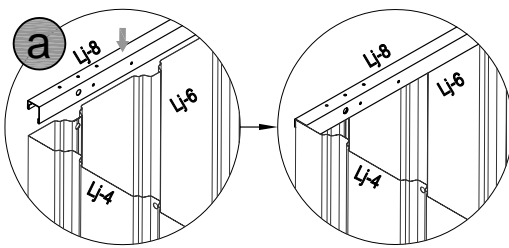
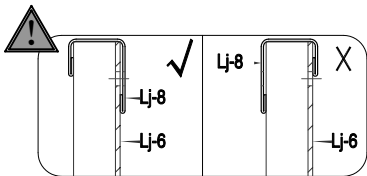



| | | | |
|----|--|---|--|
| 10 |  Lj-8 [x1] |  Lj-36 [x6] | |
|----|--|---|--|



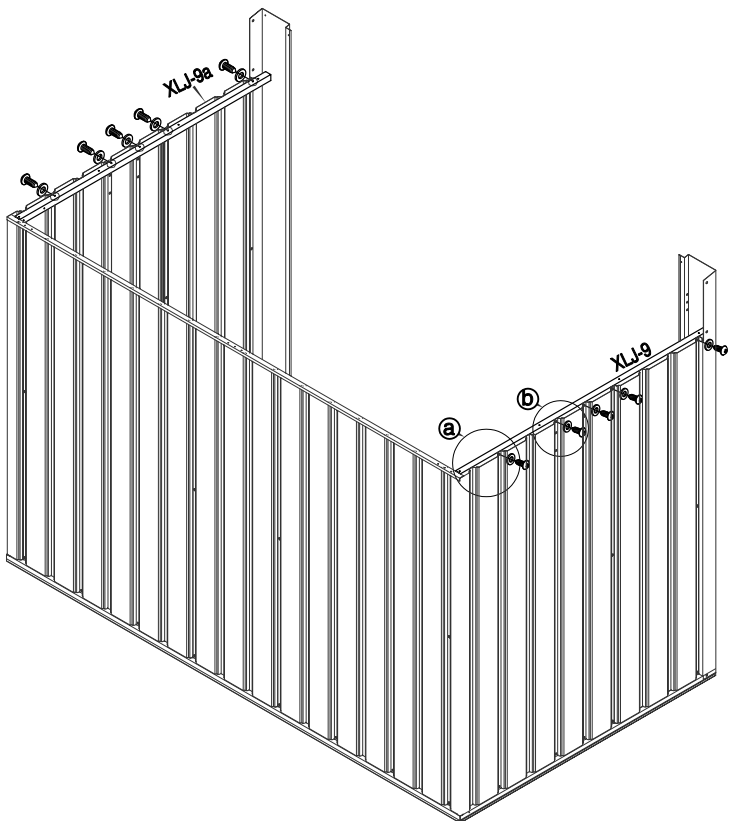
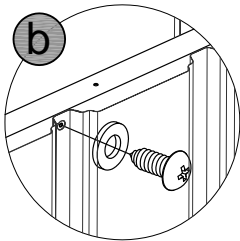
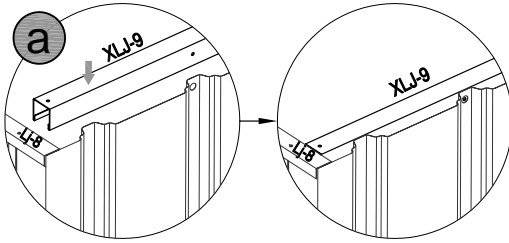

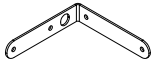

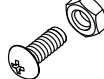
| | | | | | |
|----|---|--|--|---|--|
| 11 |  XLJ-9 [x1] |  XLJ-9a [x1] |  Lj-35 [x10] |  Lj-34 [x10] | |
|----|---|--|--|---|--|

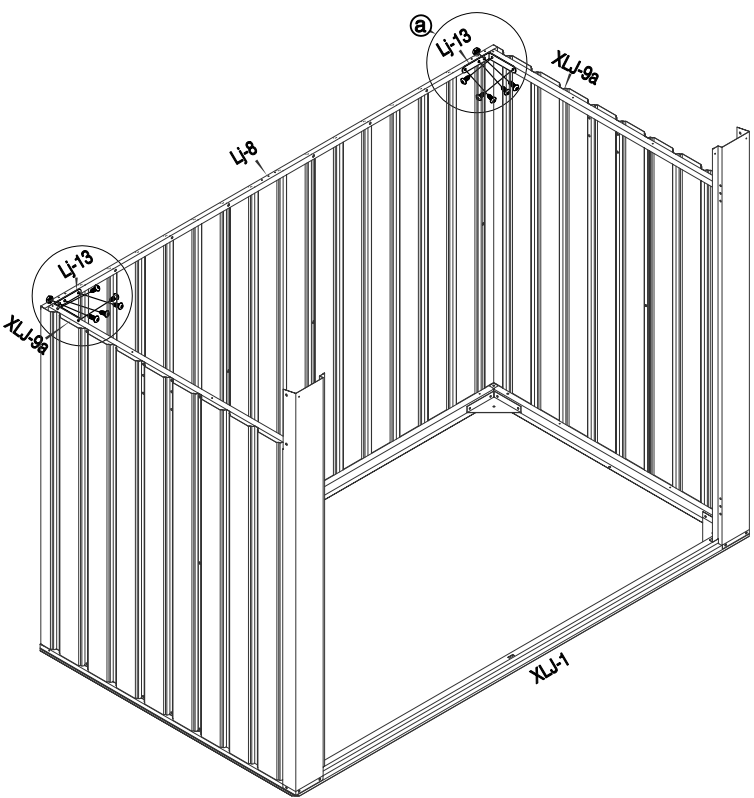
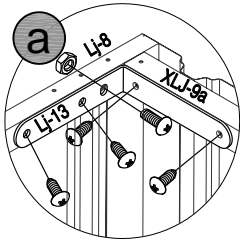

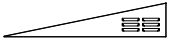
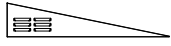

| | | | | |
|----|---|---|---|--|
| 12 |  Lj-13 [x2] |  Lj-35 [x8] |  Lj-36 [x2] | |
|----|---|---|---|--|

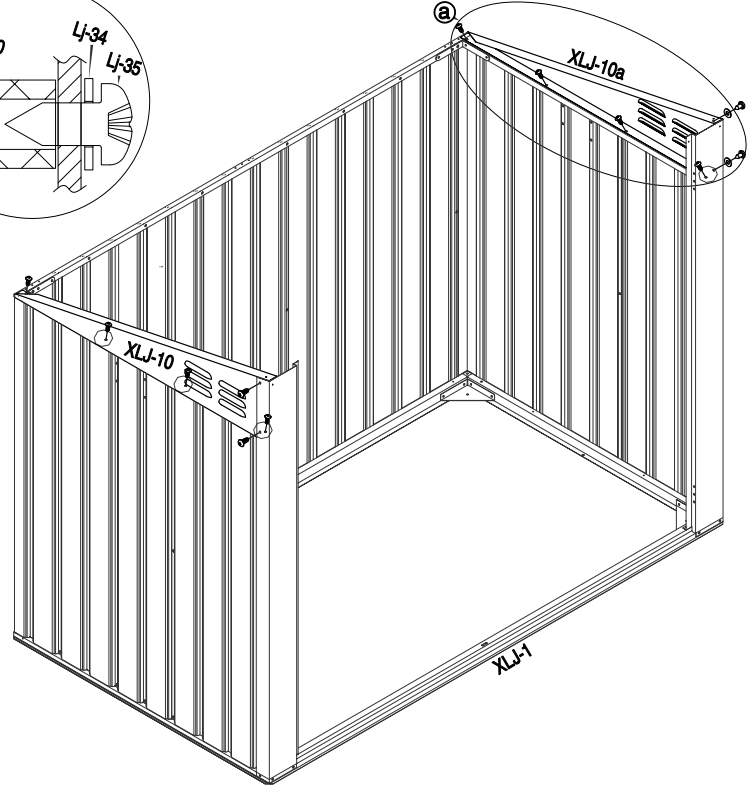
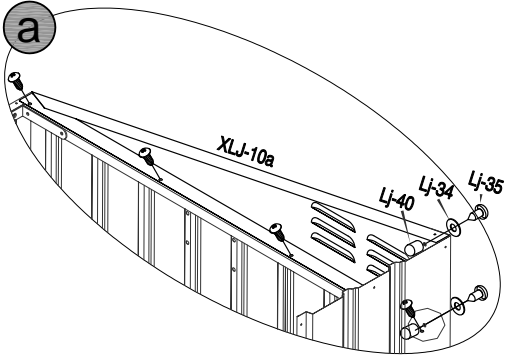
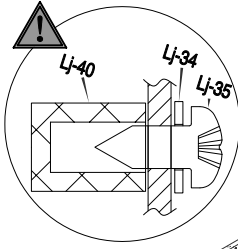
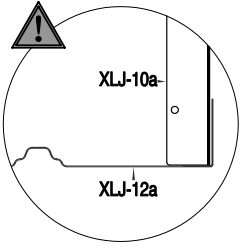
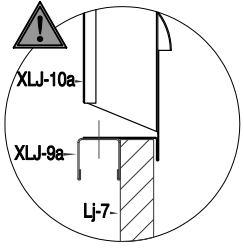

| | | | | | | |
|------------------|--|---|--|--|---|--|
| <p>13</p> |  <p>XLJ-10 [x1]</p> |  <p>XLJ-10a [x1]</p> |  <p>Lj-35 [x12]</p> |  <p>Lj-34 [x4]</p> |  <p>Lj-40 [x4]</p> | |
|------------------|--|---|--|--|---|--|



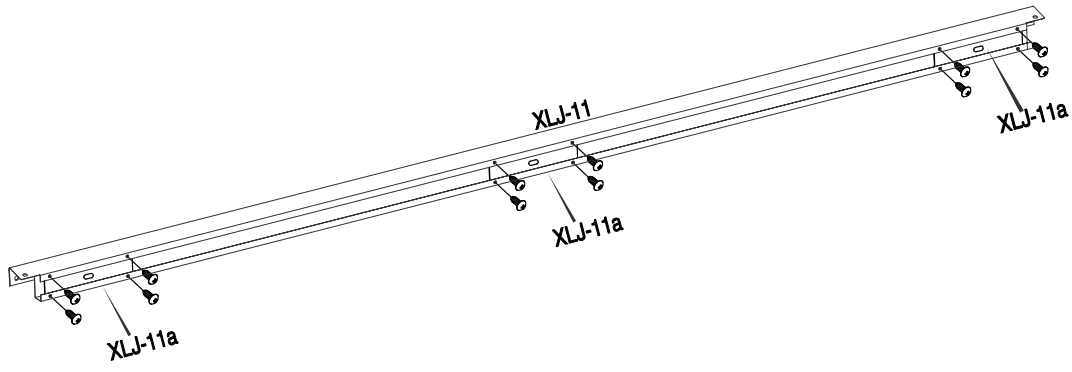
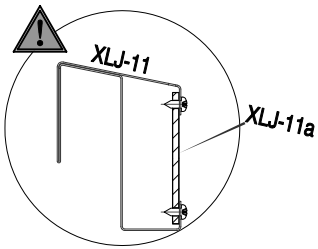

| | | | | |
|------------------|--|---|--|--|
| <p>14</p> |  <p>XLJ-11 [x1]</p> |  <p>XLJ-11a [x3]</p> |  <p>Lj-35 [x12]</p> | |
|------------------|--|---|--|--|



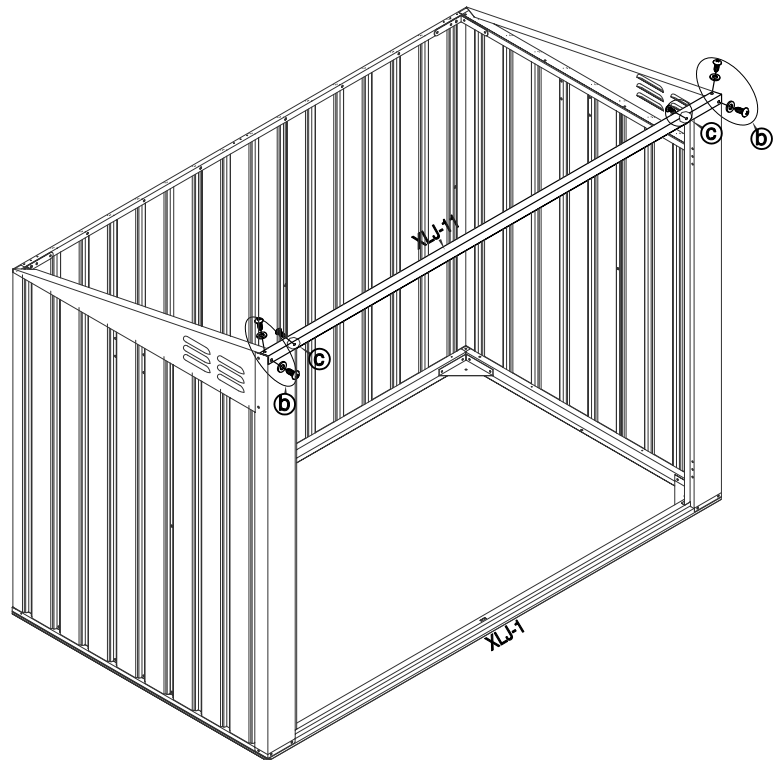
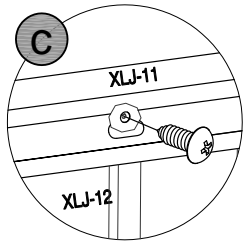
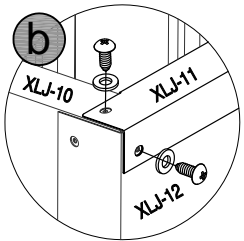
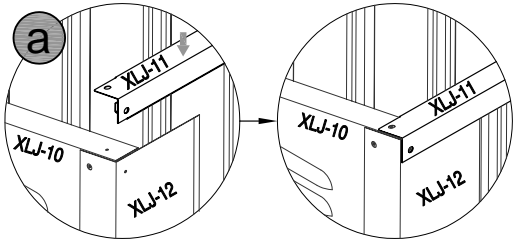

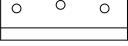
| | | | |
|------------------|---|---|--|
| <p>15</p> |  <p>Lj-35 [x6]</p> |  <p>Lj-34 [x4]</p> | |
|------------------|---|---|--|



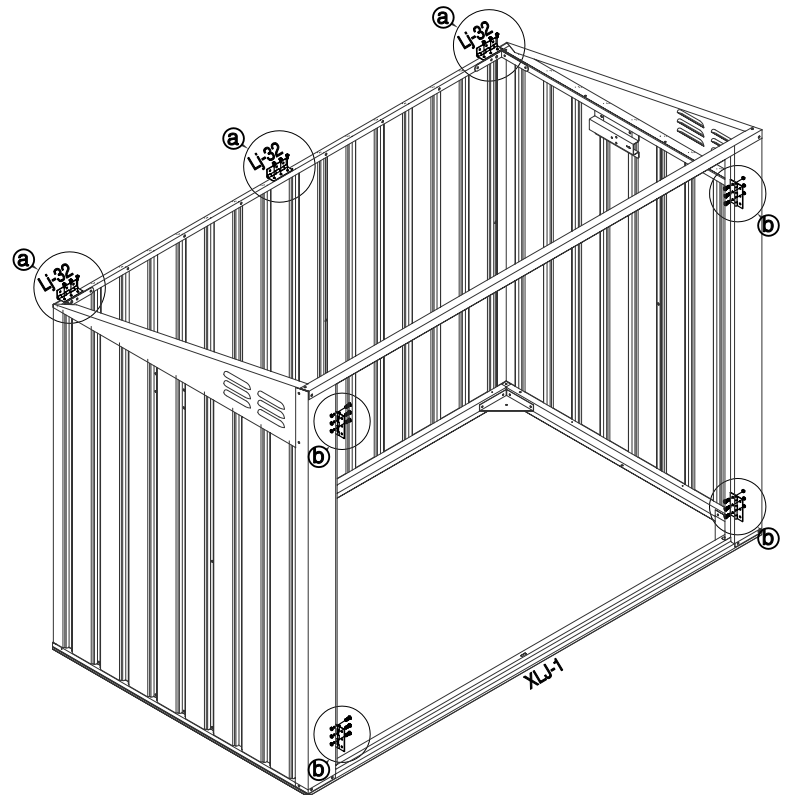
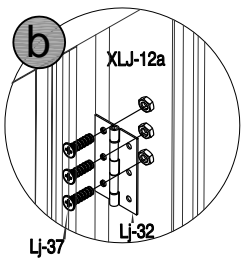
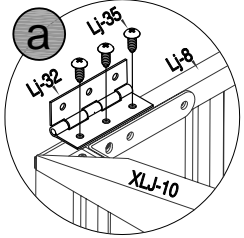

| | | | |
|------------------|---|---|--|
| <p>16</p> |  <p>Lj-32 [x7]</p> |  <p>Lj-35 [x9]</p> |  <p>Lj-37 [x12]</p> |
|------------------|---|---|--|

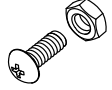

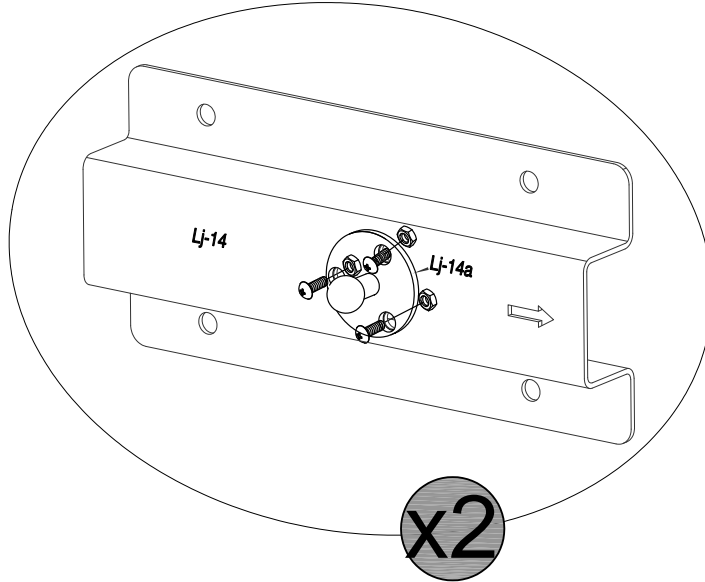
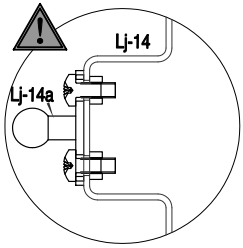

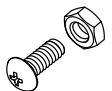

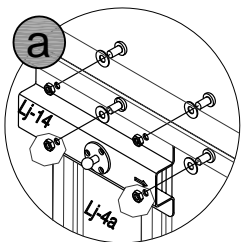
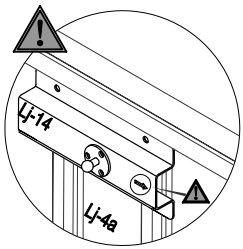

| | | | | |
|-----------|---|--|---|--|
| <p>17</p> |  <p>Lj-14 [x2]</p> |  <p>Lj-14a [x2]</p> |  <p>Lj-36 [x6]</p> | |
|-----------|---|--|---|--|



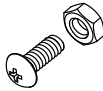

| | | | |
|-----------|---|---|--|
| <p>18</p> |  <p>Lj-36 [x8]</p> |  <p>Lj-34 [x8]</p> | |
|-----------|---|---|--|



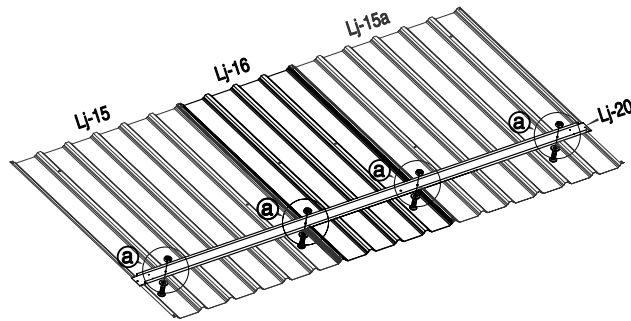
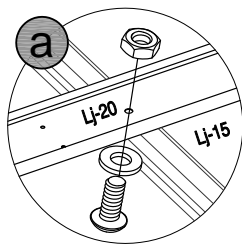
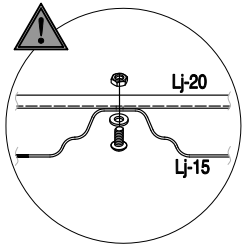
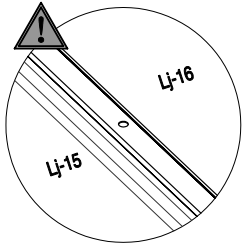
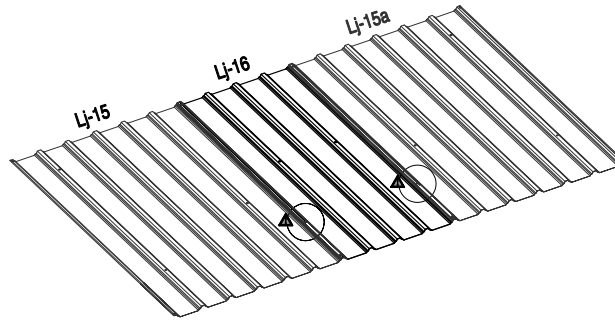
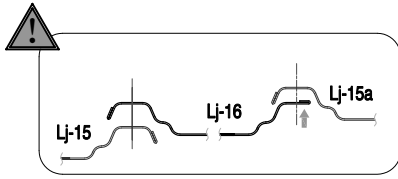

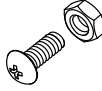

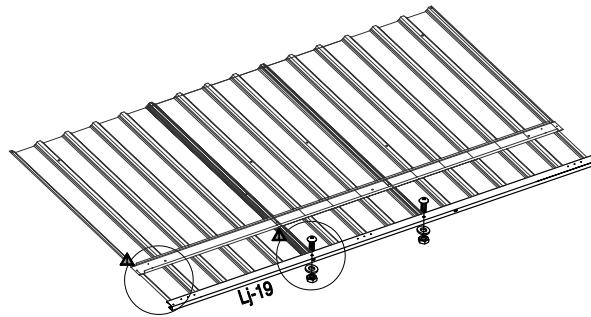
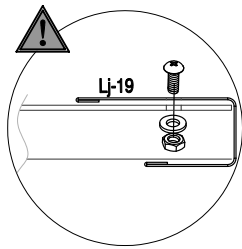
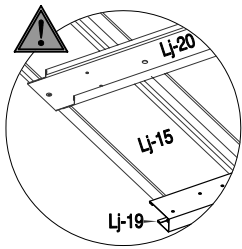

| | | | | | | |
|----|---|--|---|--|---|---|
| 19 |  Lj-15 [x1] |  Lj-15a [x1] |  Lj-16 [x1] |  Lj-20 [x1] |  Lj-36 [x4] |  Lj-34 [x4] |
|----|---|--|---|--|---|---|







| | | | | |
|----|---|---|---|--|
| 20 |  Lj-19 [x1] |  Lj-36 [x2] |  Lj-34 [x2] | |
|----|---|---|---|--|

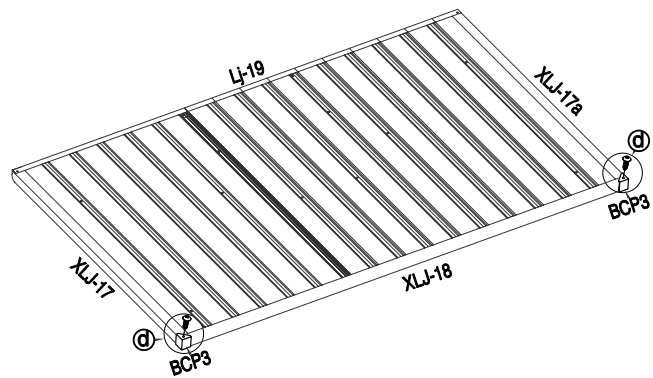
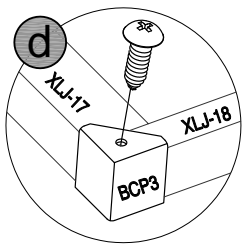
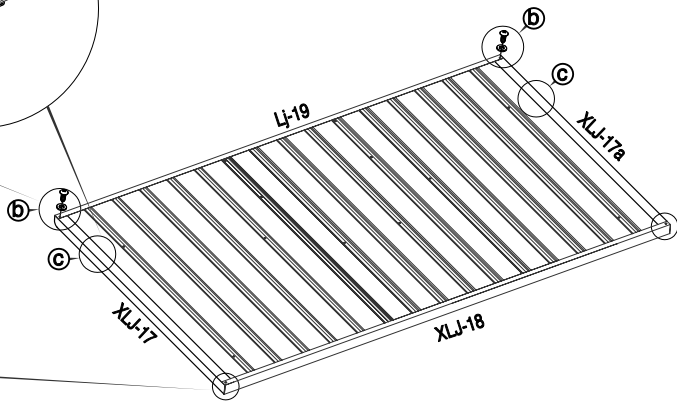
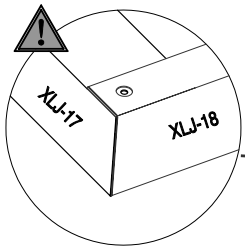
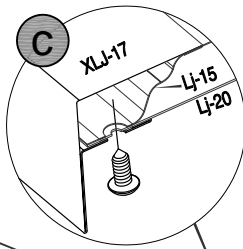
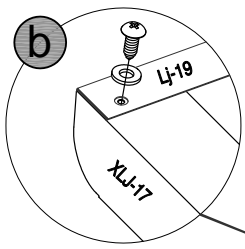
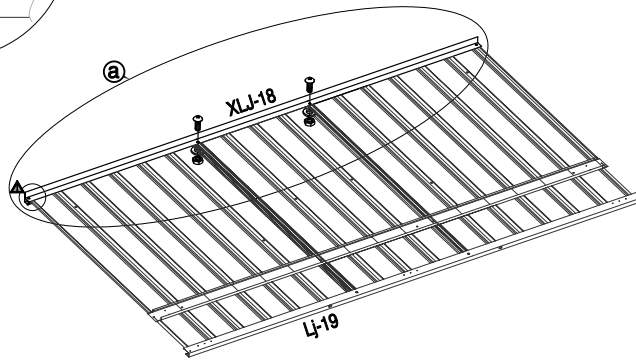
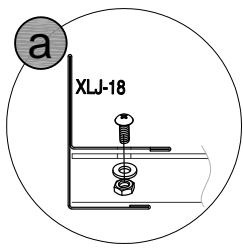
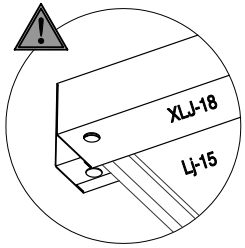

| | | | | | | |
|----|--|--|---|--|---|---|
| 21 |  XLJ-18 [x1] |  XLJ-17 [x1] |  XLJ-17a [x1] |  BCP3 [x2] |  Lj-36 [x2] |  Lj-35 [x6] |
| | | | | | |  Lj-34 [x4] |



| | | | | | |
|--|---|--|---|--|--|
|  |  Lj-21 [x2] |  Lj-14b [x2] |  Lj-35 [x8] |  Lj-36 [x4] | |
|--|---|--|---|--|--|

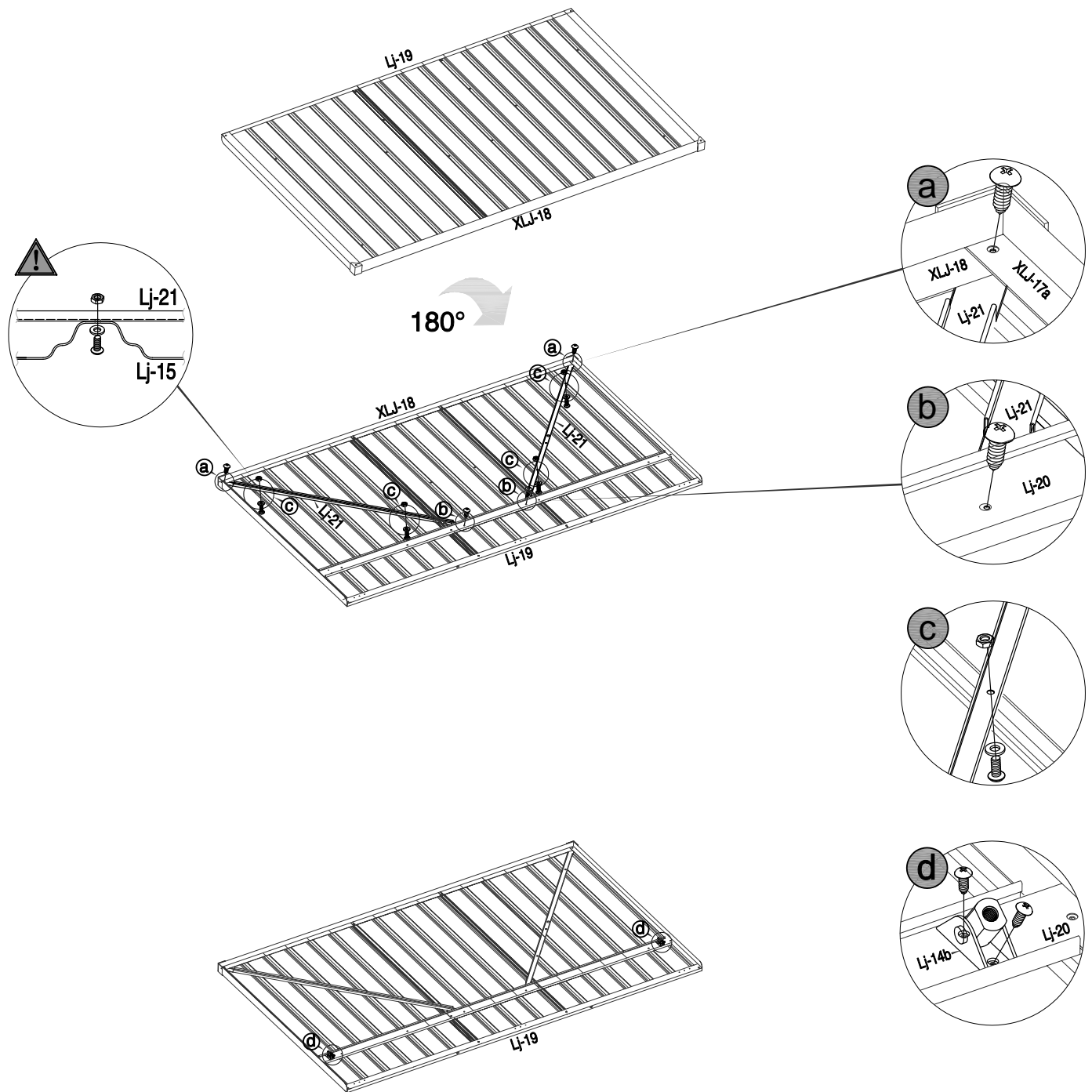

23



Lj-35 [x9]

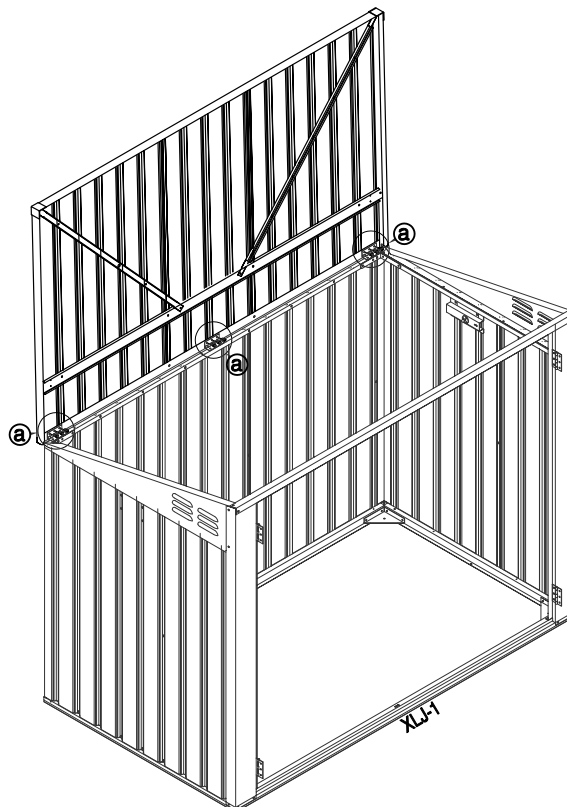
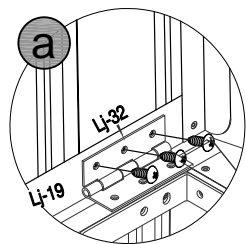



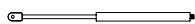

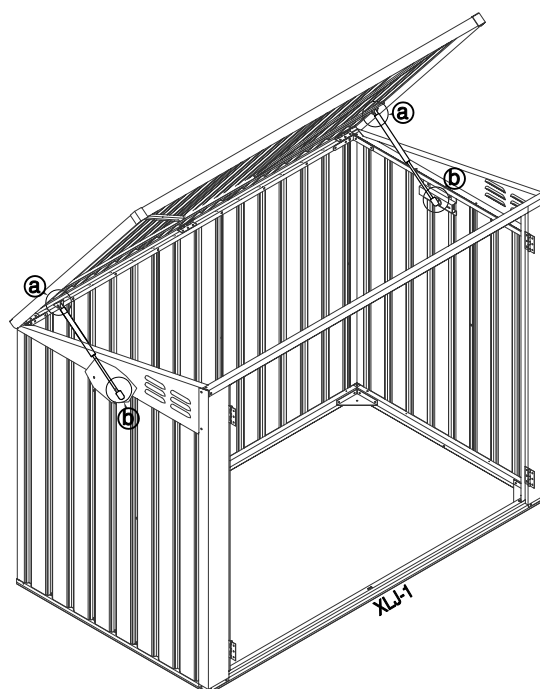
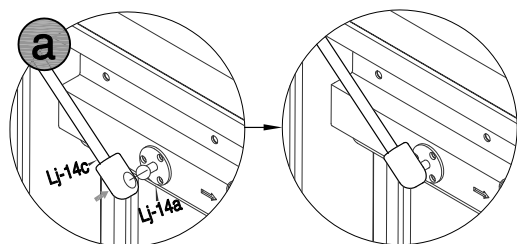
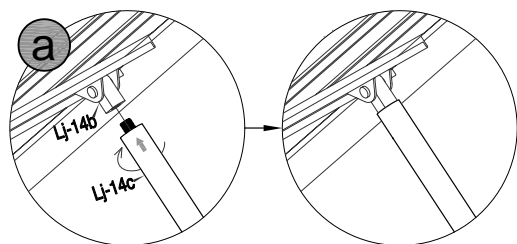

24







Lj-14c [x2]

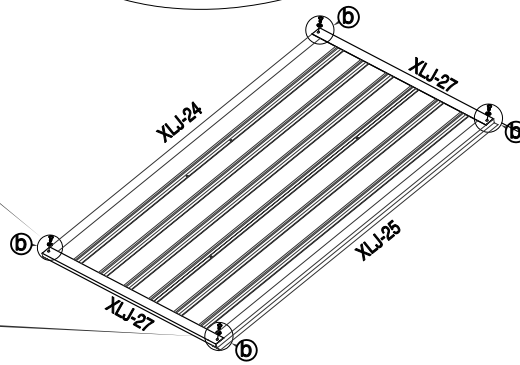
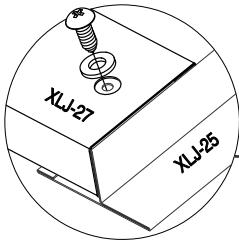
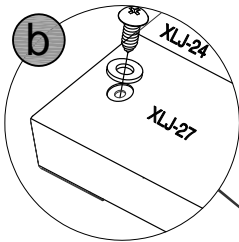
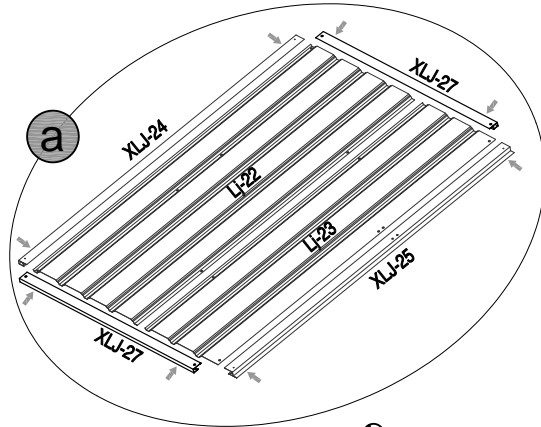
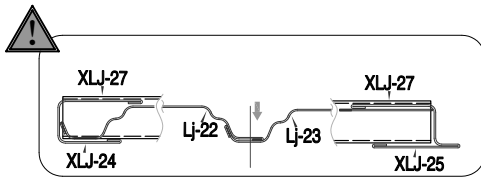

| | | | | | | |
|-----------|--|--|---|---|---|--|
| 25 |  Lj-22 [x1] |  Lj-23 [x1] |  XLJ-27 [x2] |  XLJ-24 [x1] |  XLJ-25 [x1] |  Lj-35 [x4] |
|-----------|--|--|---|---|---|--|



| | | | | | |
|-----------|--|--|--|---|--|
| 26 |  Lj-29 [x1] |  Lj-28 [x2] |  Lj-35 [x4] |  Lj-36 [x4] |  Lj-34 [x4] |
|-----------|--|--|--|---|--|

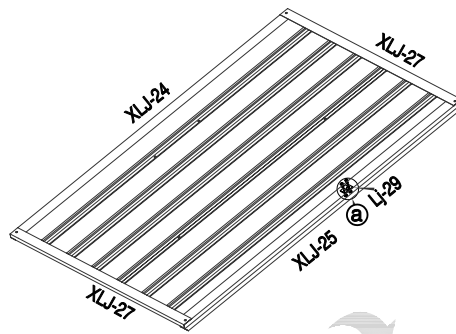
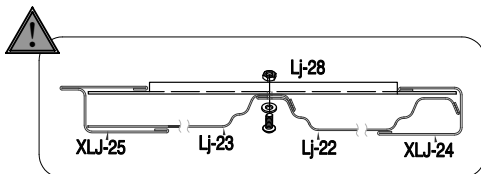
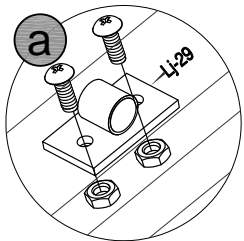



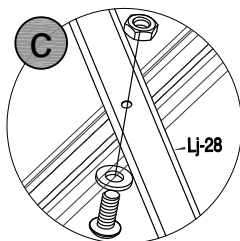
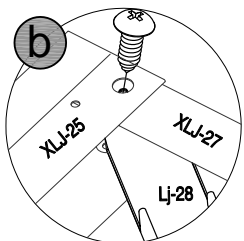
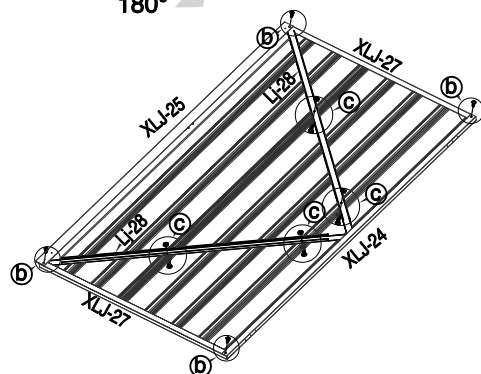

180°

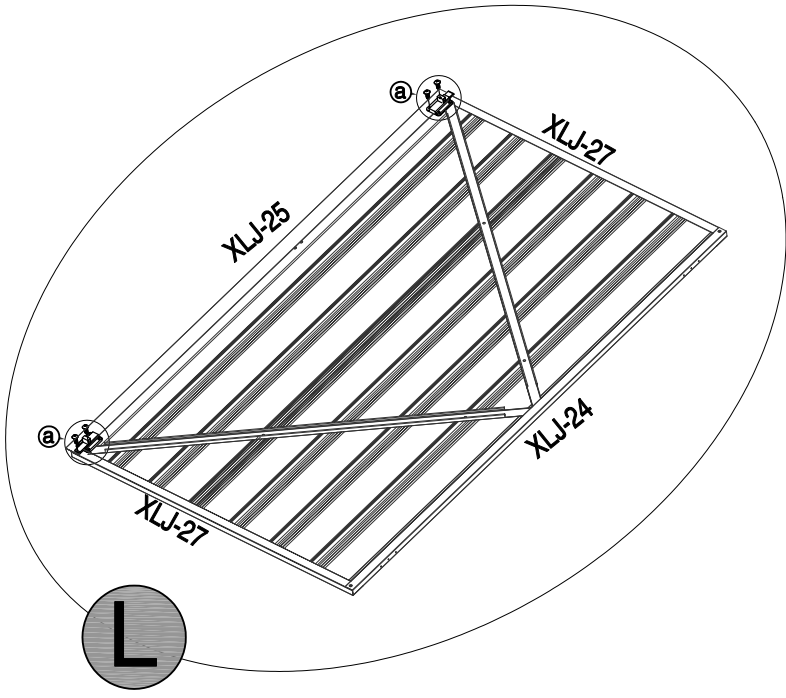
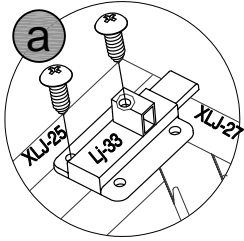

| | | | |
|----|---|---|--|
| 27 |  Lj-33 [x2] |  Lj-35 [x4] | |
|----|---|---|--|





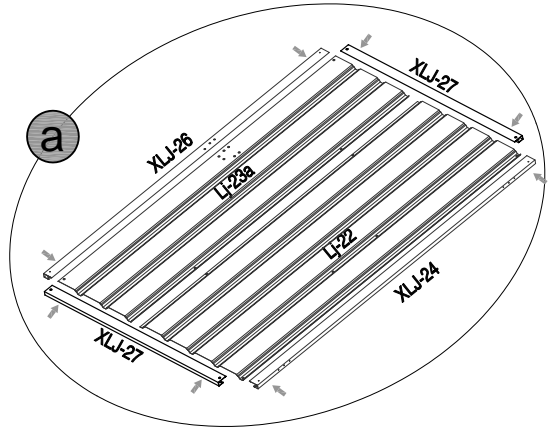
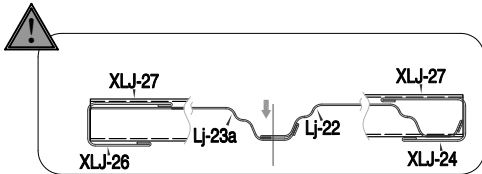

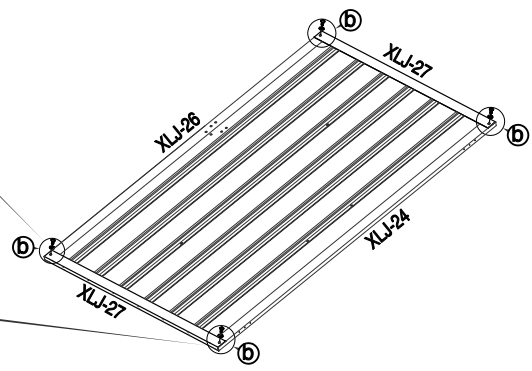
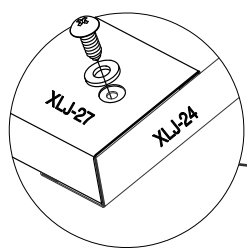
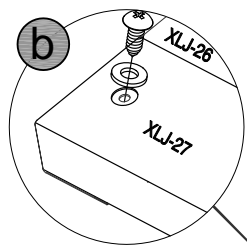

| | | | | | | |
|----|---|--|--|--|--|---|
| 28 |  Lj-22 [x1] |  Lj-23a [x1] |  XLJ-27 [x2] |  XLJ-24 [x1] |  XLJ-26 [x1] |  Lj-35 [x4] |
|----|---|--|--|--|--|---|



| |
|---|
|  Lj-34 [x4] |
|---|



| | | | | | | |
|------------------|---|---|---|--|--|---|
| <p>29</p> |  <p>Lj-30 [x1]</p> |  <p>Lj-31 [x1]</p> |  <p>Lj-28 [x2]</p> |  <p>Lj-35 [x4]</p> |  <p>Lj-36 [x10]</p> |  <p>Lj-34 [x4]</p> |
|------------------|---|---|---|--|--|---|

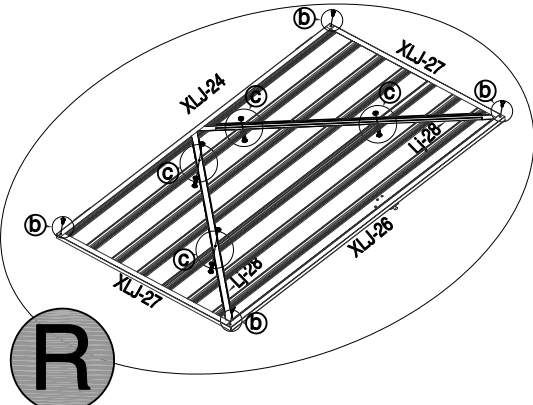
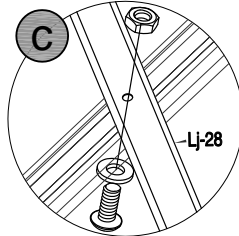
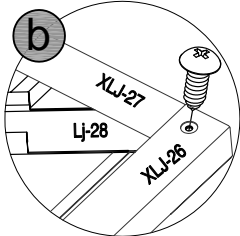
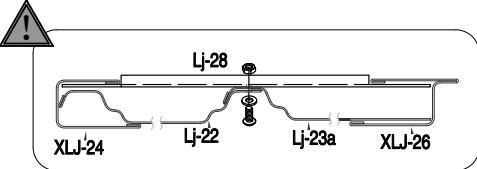
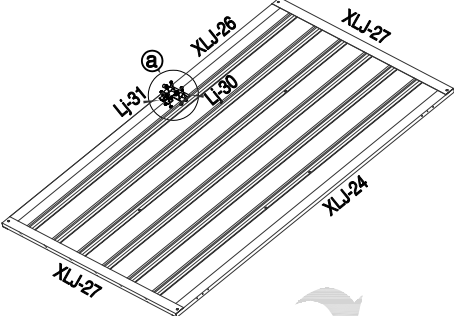
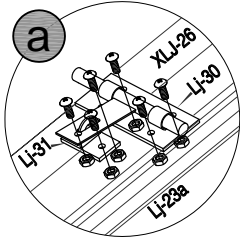

| | | |
|------------------|---|--|
| <p>30</p> |  <p>Lj-35 [x6]</p> | |
|------------------|---|--|

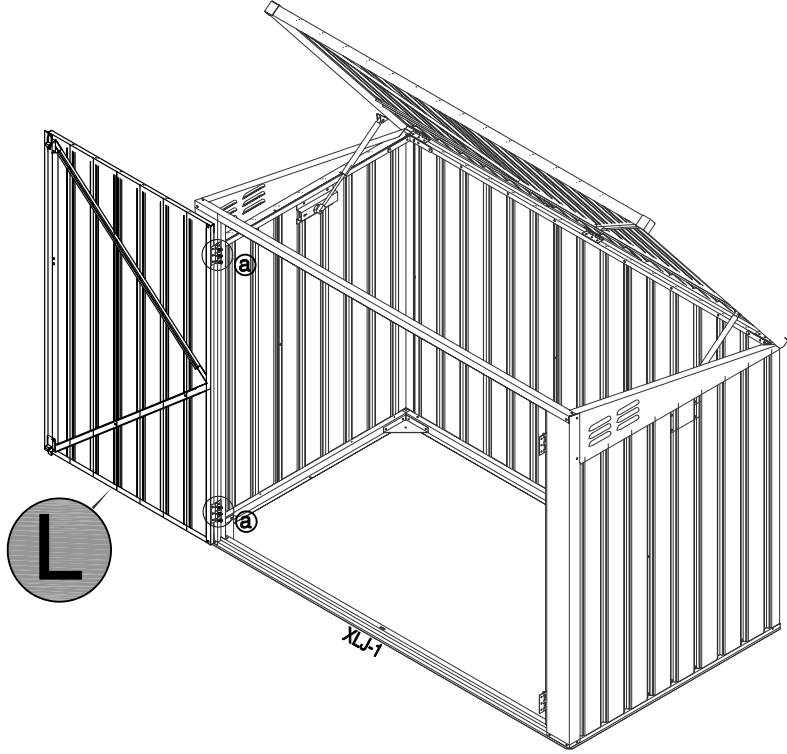
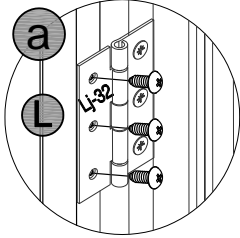

31



Lj-35 [x6]

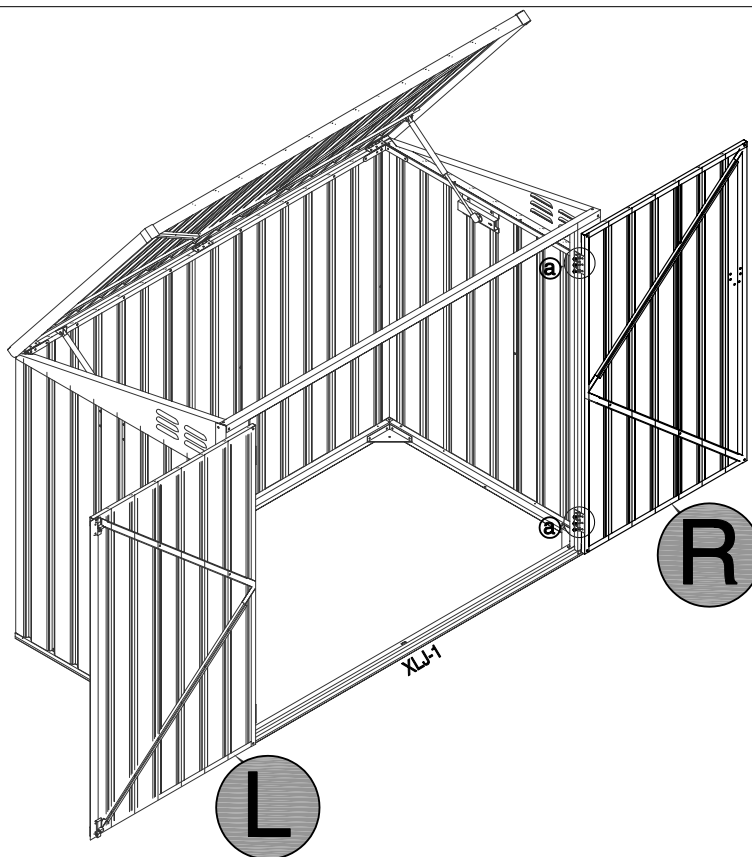
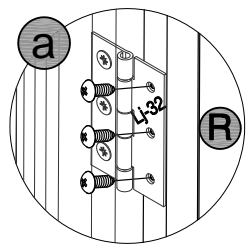

32



Lj-41 [x2]

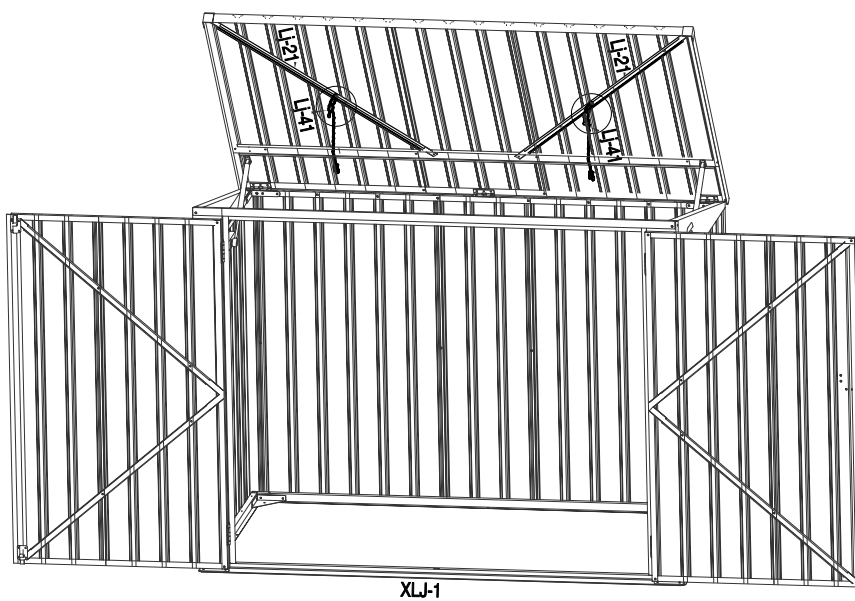
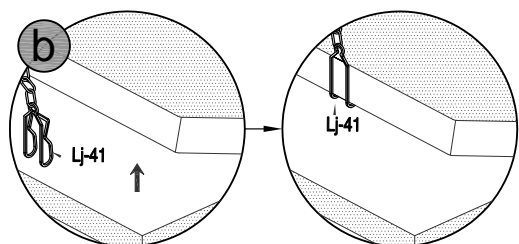
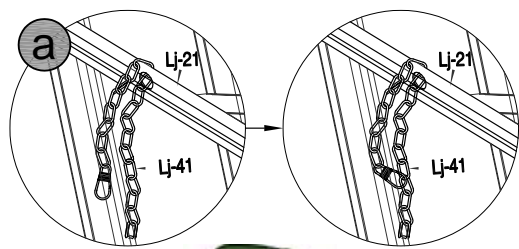

33

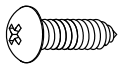

Lj-38 [x8]

