

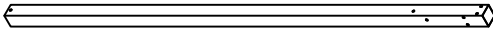

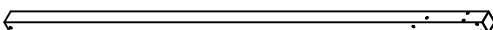

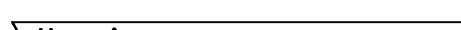



- A  x 1
- B  x 1
- C  x 1
- D  x 1
- E  x 2
- G  x 1
- H  x 3
- J  x 6
- K  x 6
- L  x 2
- M  x 2

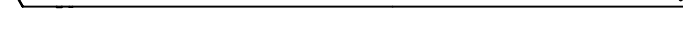
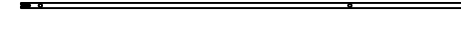

1

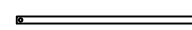

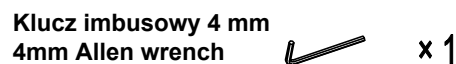
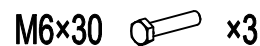
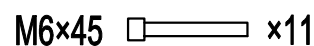
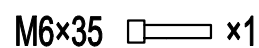
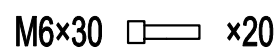
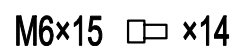
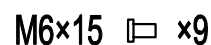
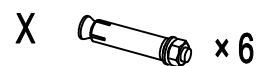
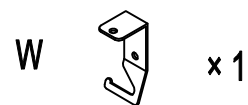
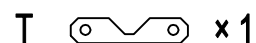
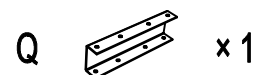
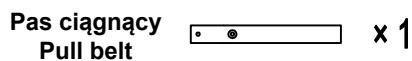
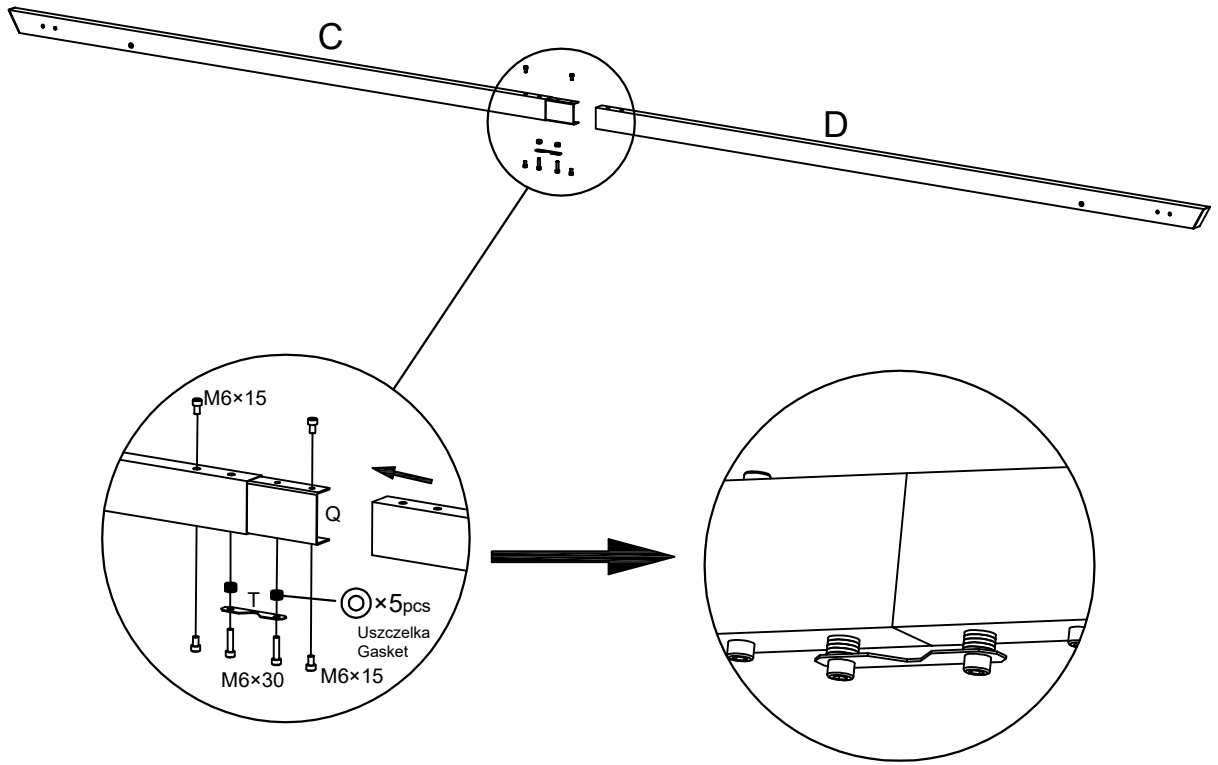
x1

2

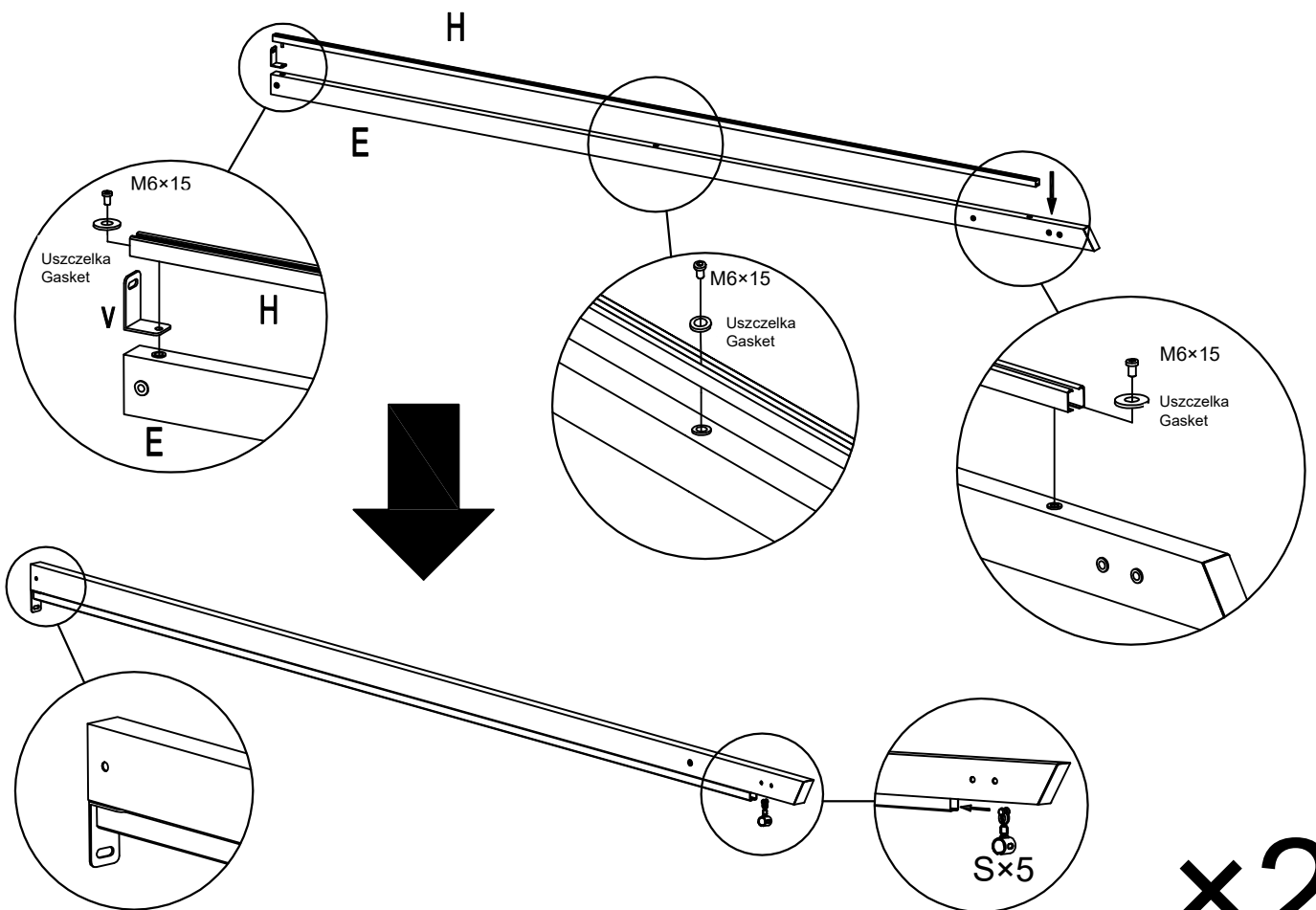

x2

3

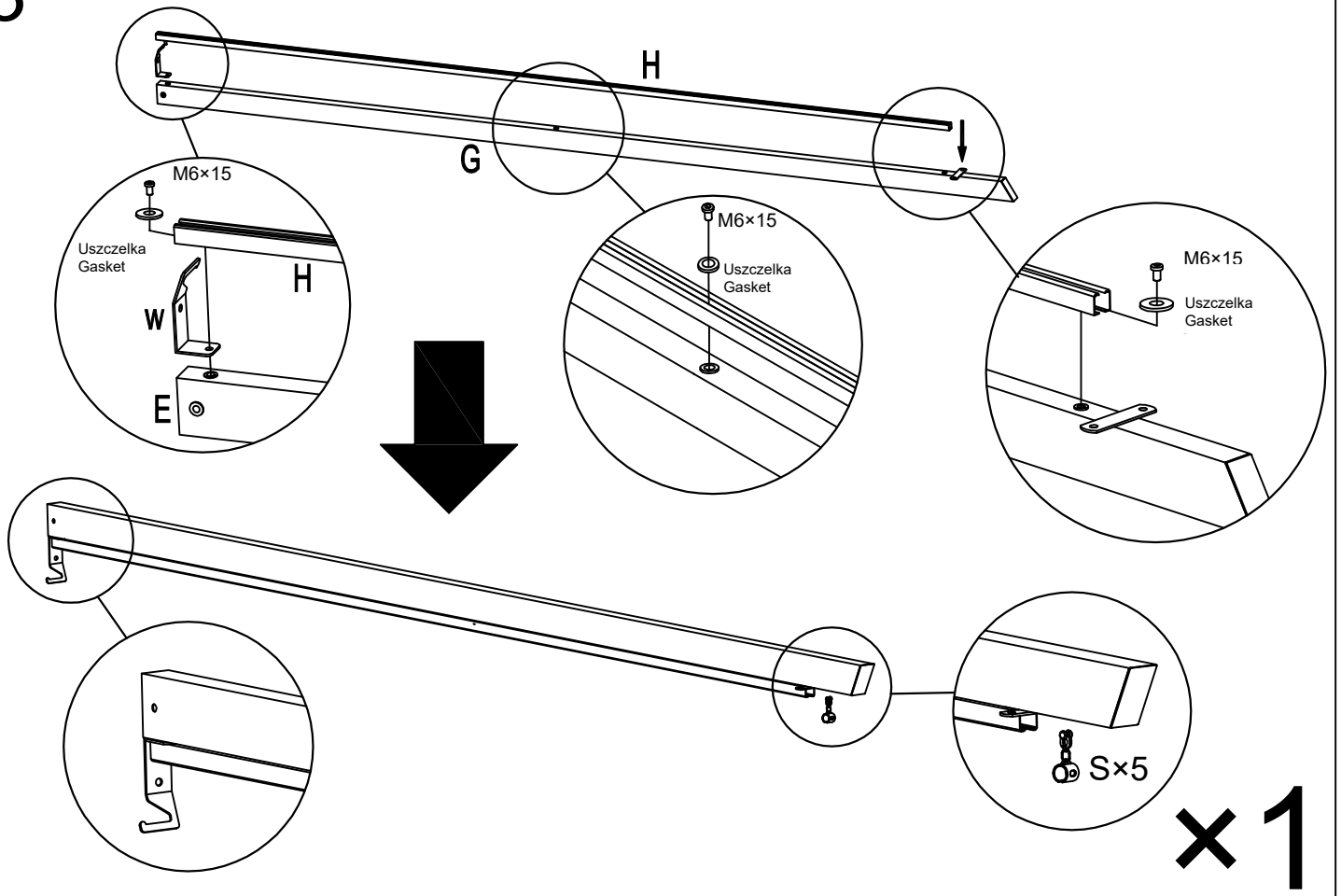

4

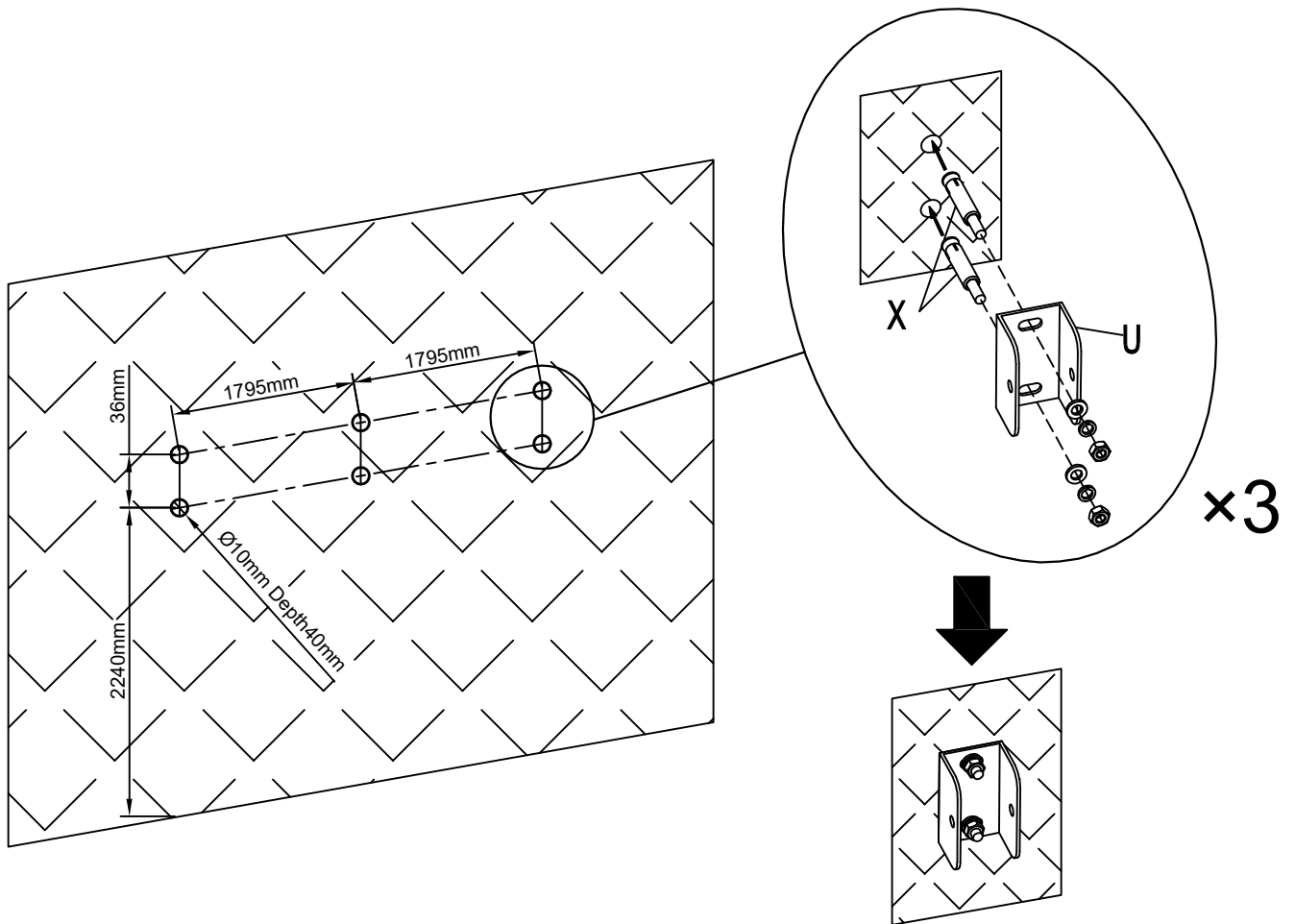

5

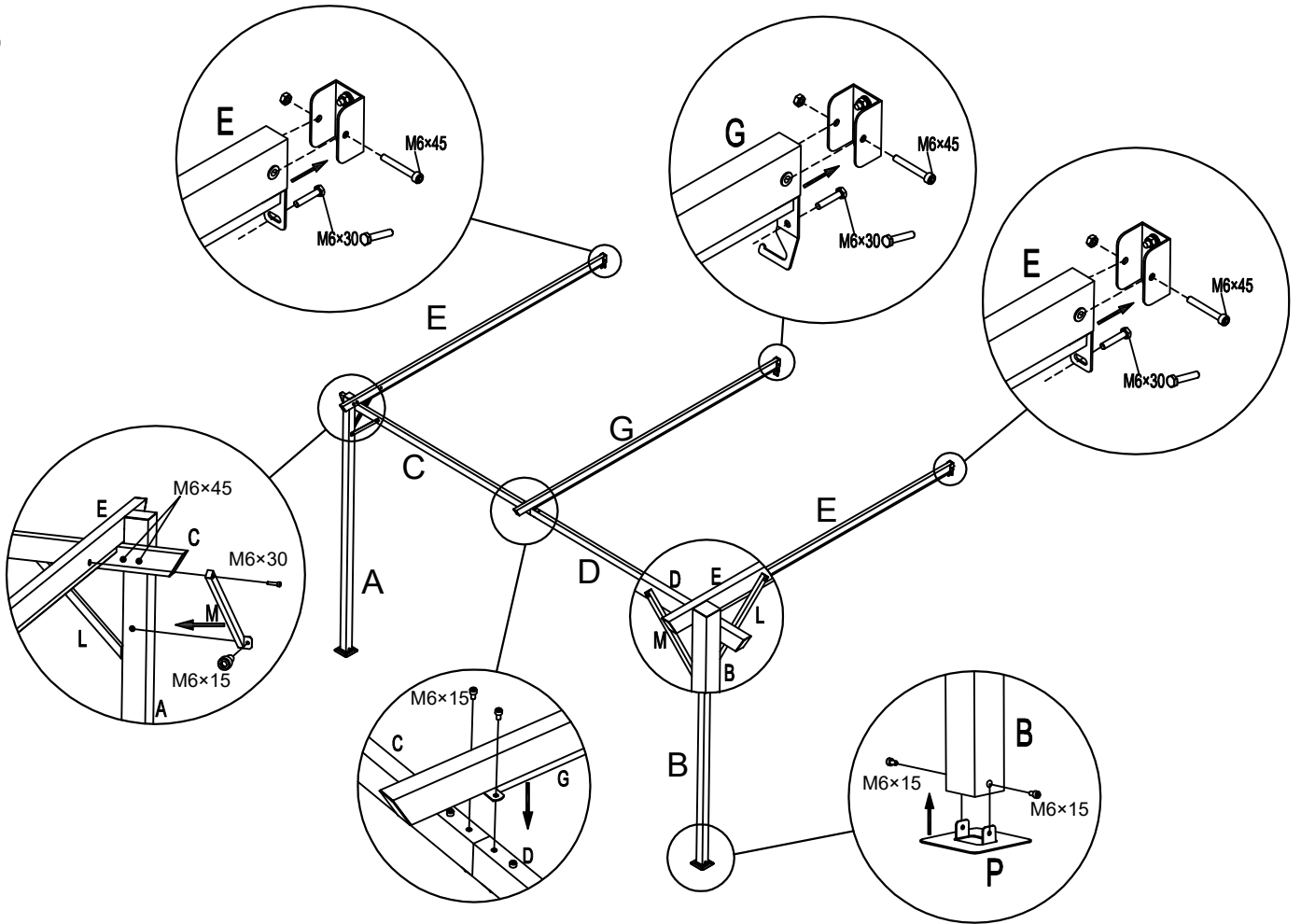

6

