

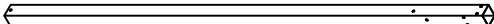

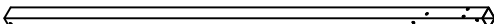





- A  x 2
- B  x 2
- C  x 2
- D  x 2
- E  x 2
- G  x 1
- H  x 3
- J  x 6
- K  x 6
- L  x 4
- M  x 4

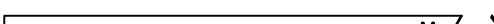
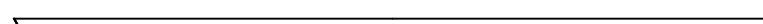

1

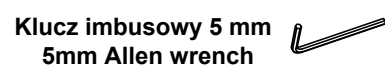
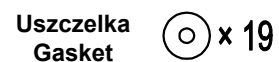
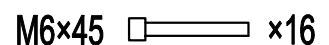
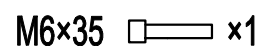
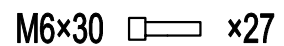
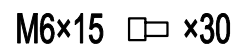
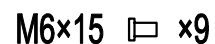
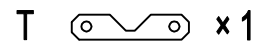
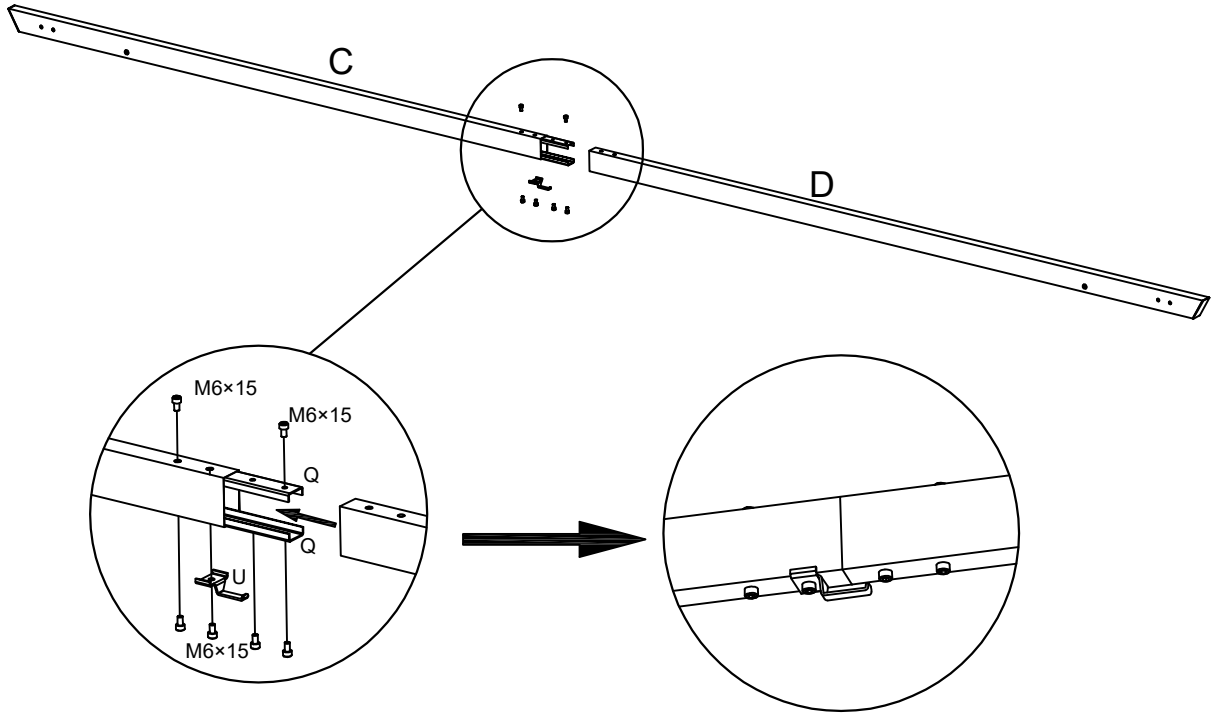

×1

2

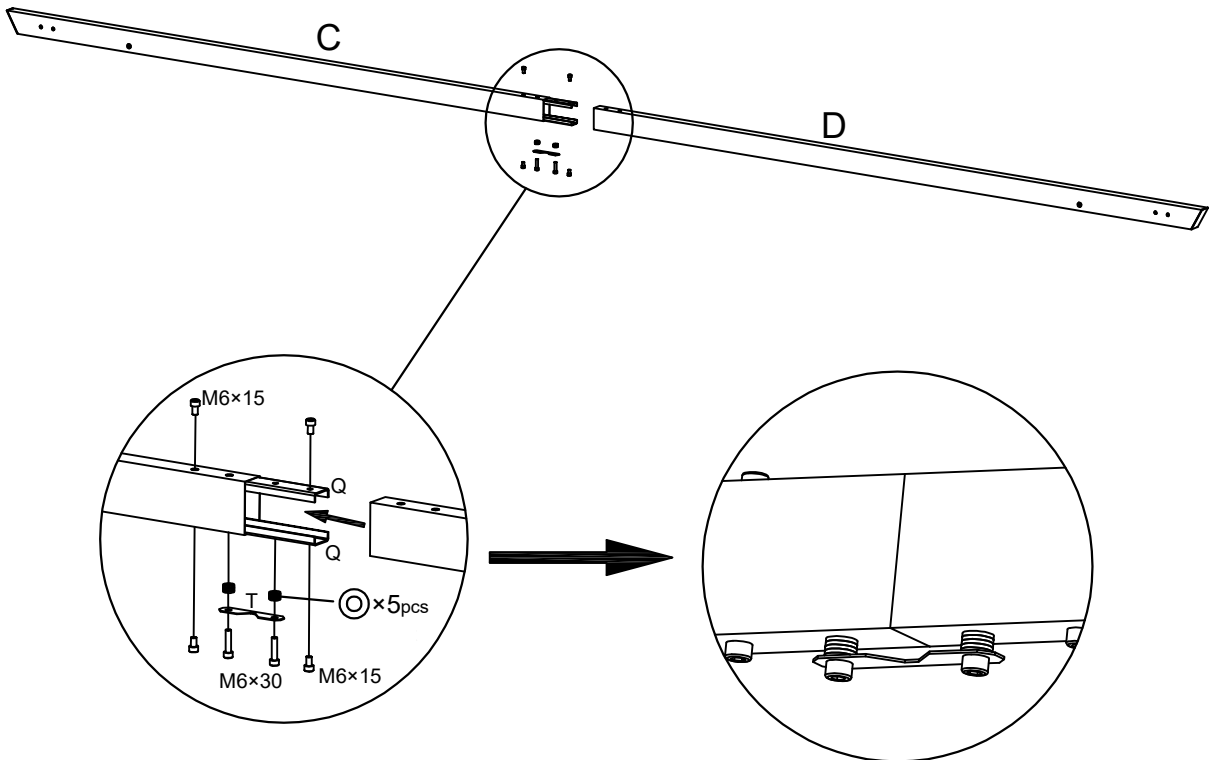

×1

3

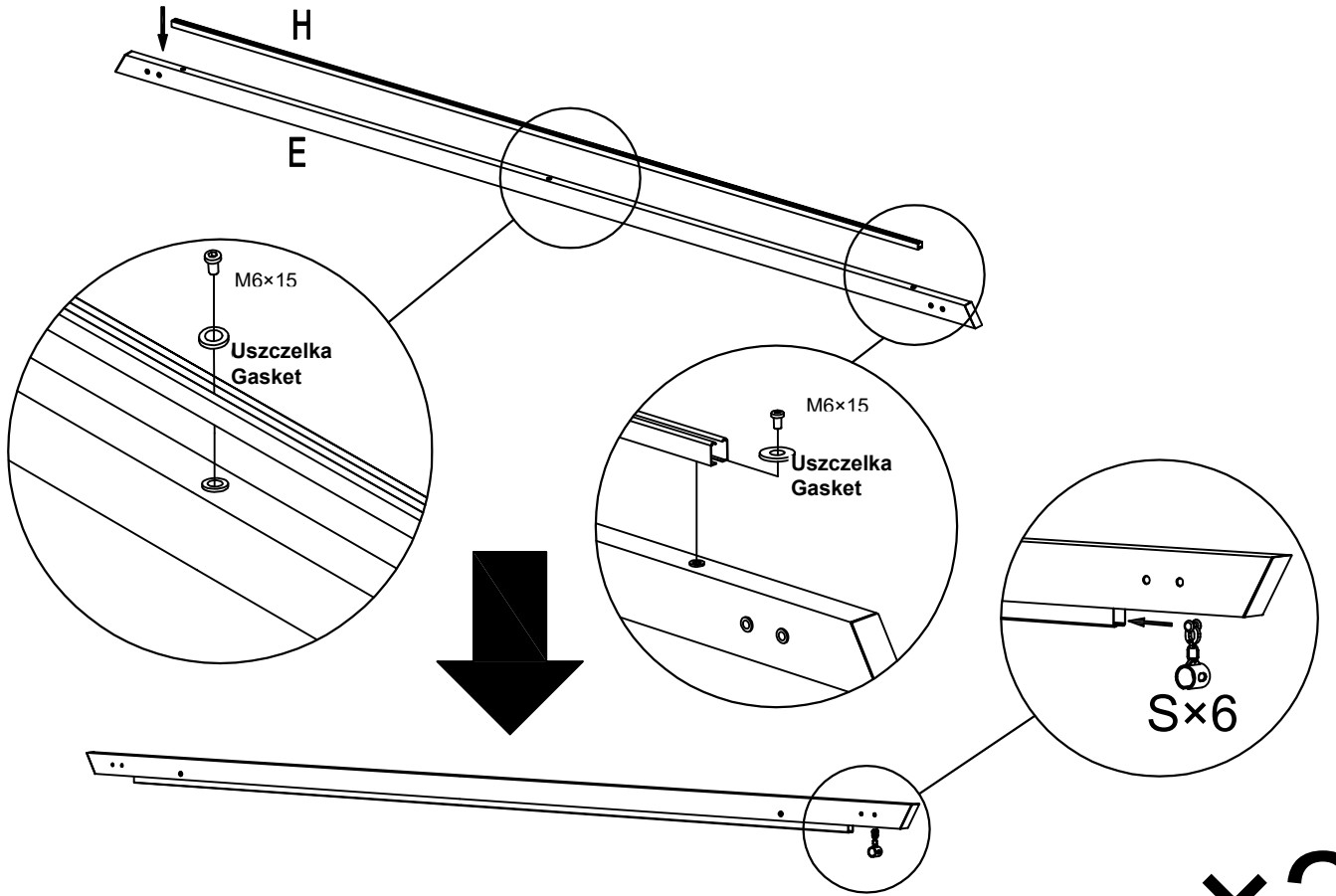

x2

4

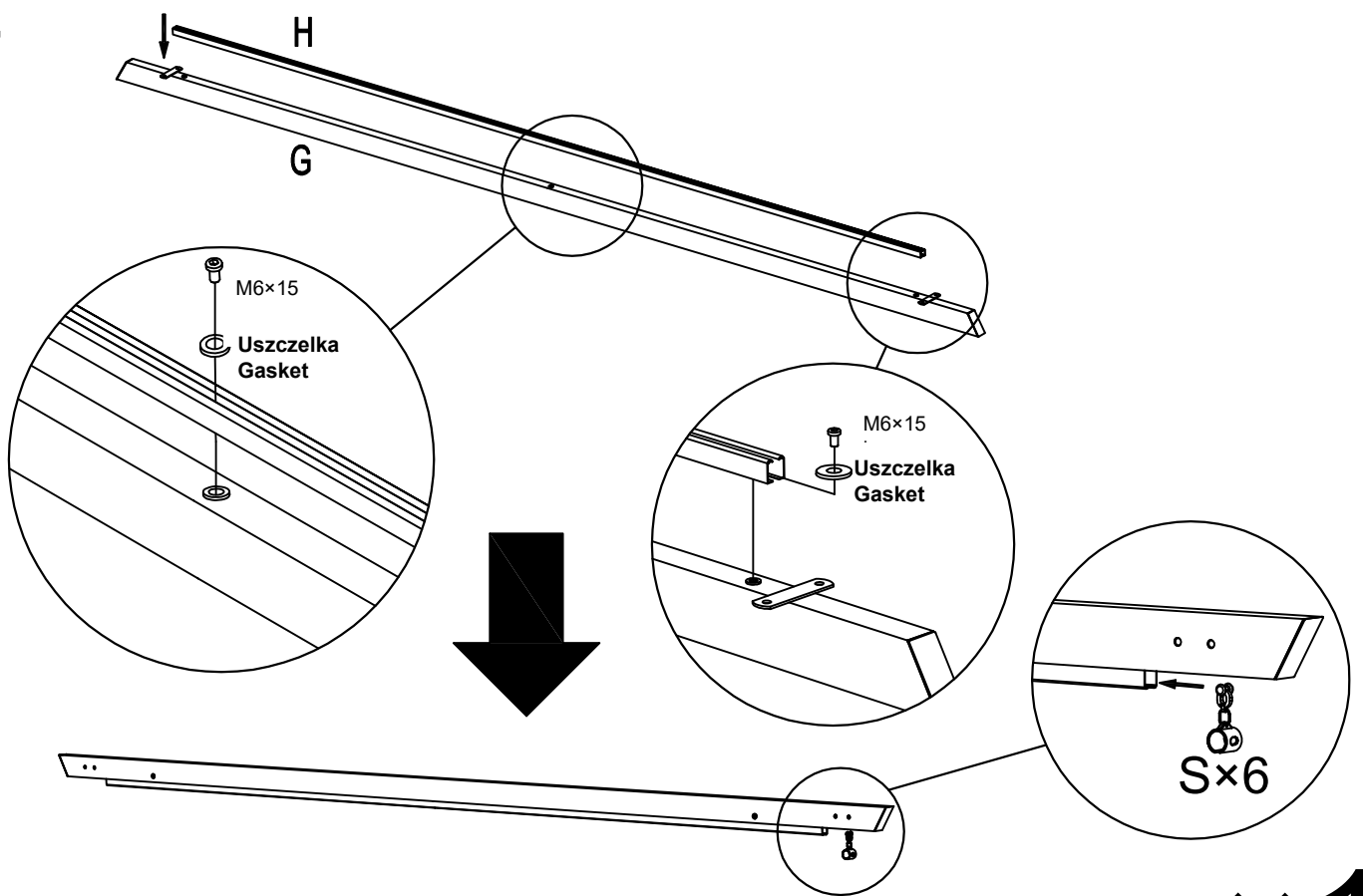

x1

5

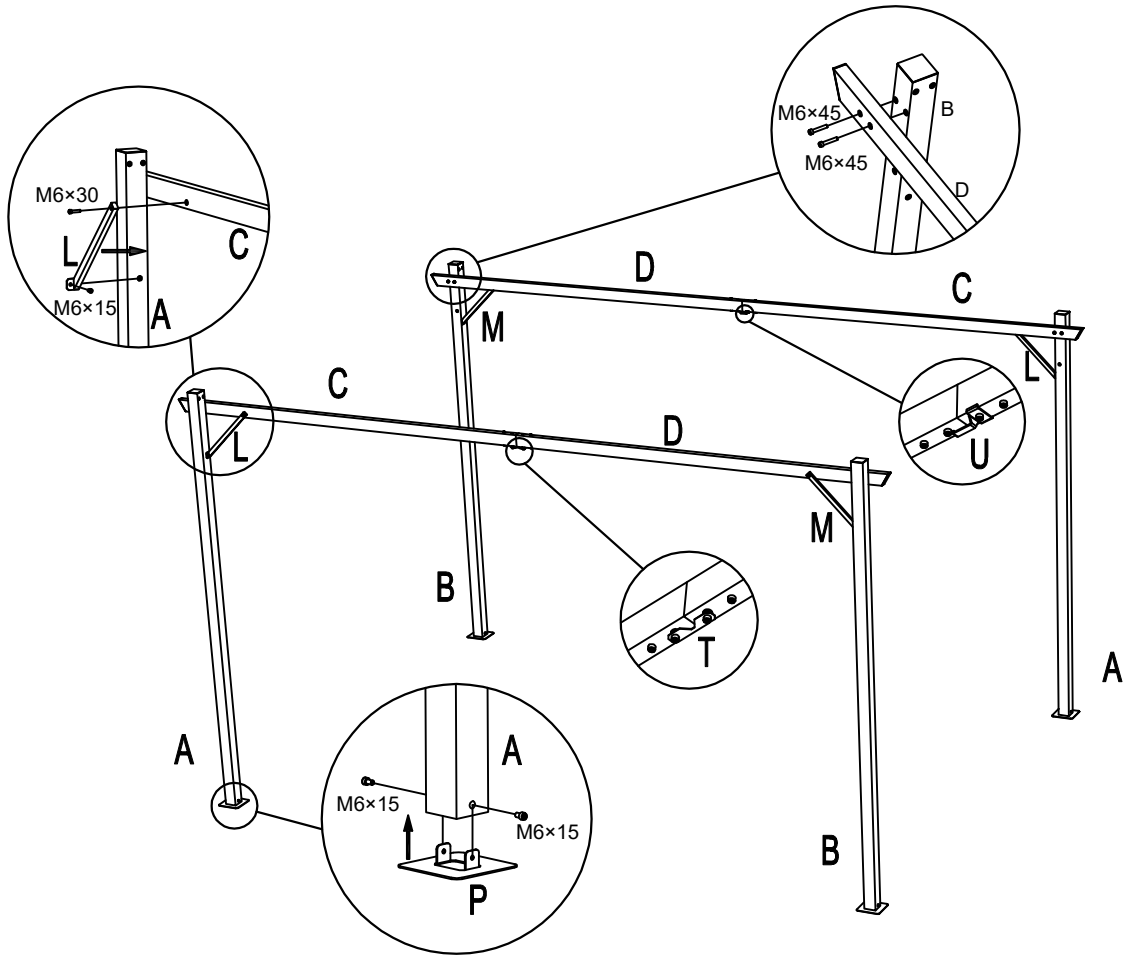

6

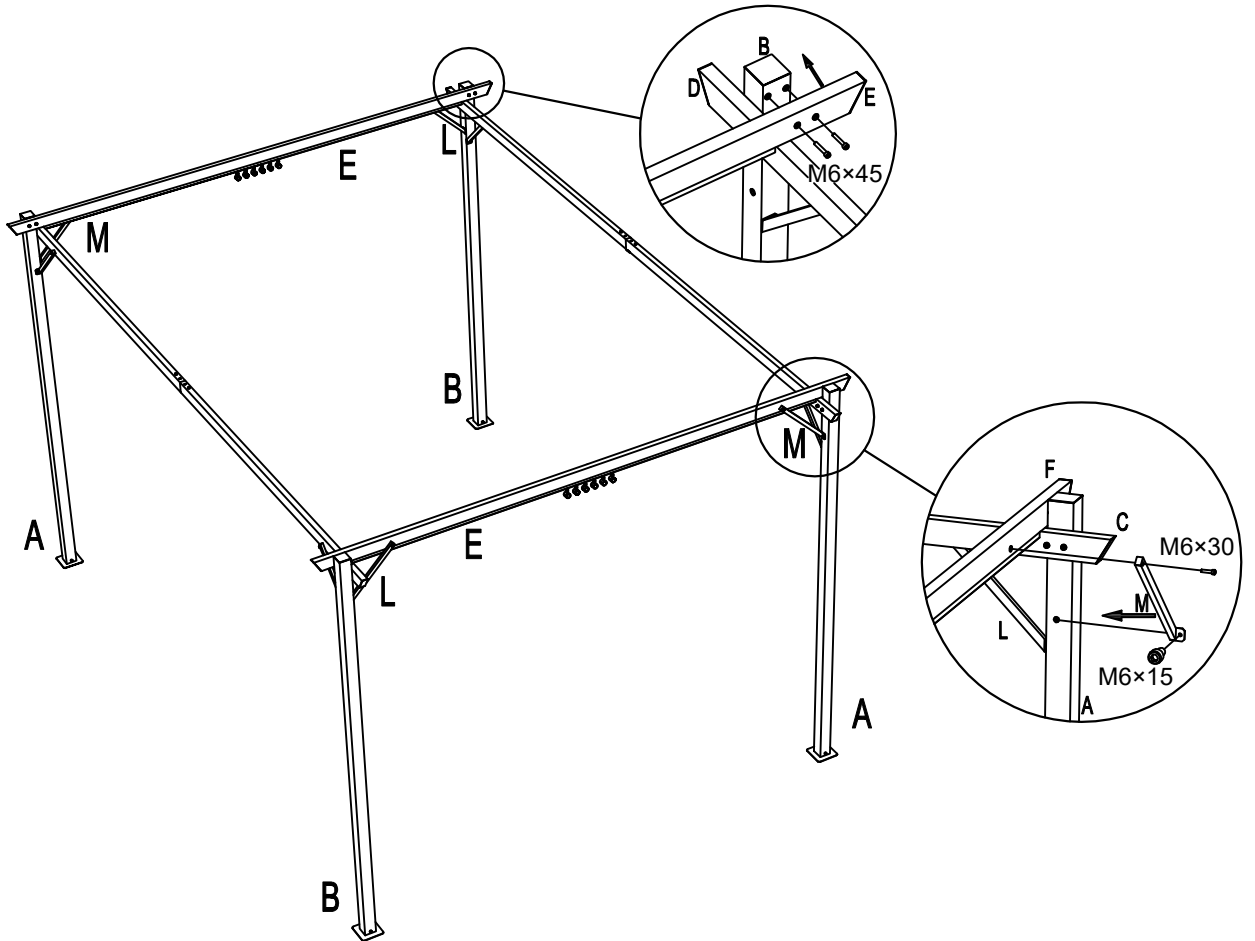

7

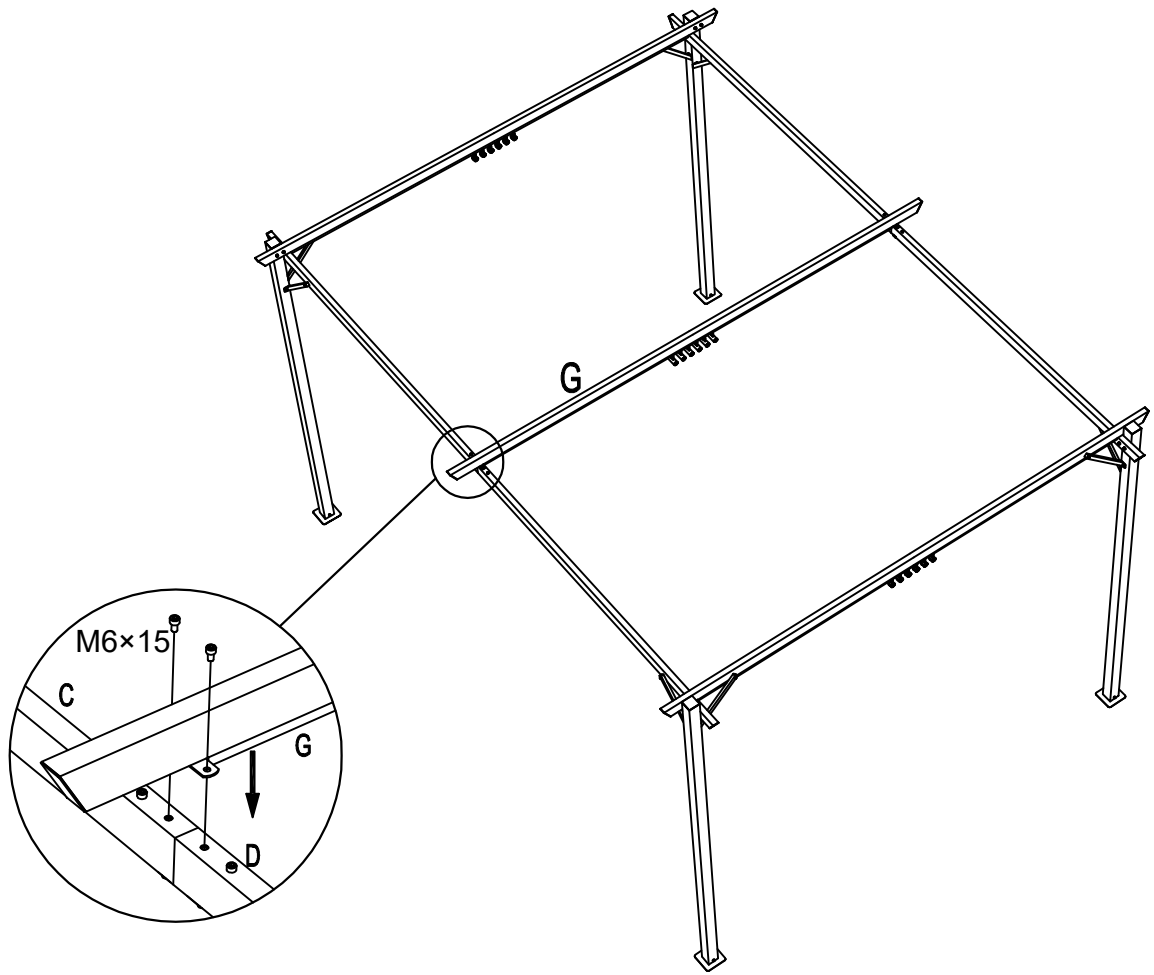

8

